



Enterprise User's Guide

Patent and Legal Notices

Copyright © 2019 ePlus Capital, inc.

This product and related documentation are furnished under a license agreement and may be used or copied only in accordance with the terms of the agreement. No part of this product or related documentation may be reproduced in any form or by any means without the prior written authorization of ePlus Capital, inc. While every precaution has been taken in the preparation of this documentation, ePlus Capital, inc. assumes no responsibility for errors or omissions. Information in this document is subject to change without notice.

WARNING

This computer program is protected by copyright law and international treaties. Unauthorized reproduction or distribution of this program, or any portion of it, may result in severe civil and criminal penalties, and will be prosecuted to the maximum extent possible under the law.

Trademarks

ePlus, DirectSight, DocPak, ViewMark, and ePlus products referenced herein are either registered trademarks or trademarks of ePlus inc. in the United States and/or other countries. The names of other companies and products mentioned herein may be the trademarks of their respective owners.

PostScript is either a registered trademark or a trademark of Adobe in the United States and/or other countries.

Microsoft, Windows, Windows Server, Active Directory, NTFS, Internet Explorer, Excel, Powerpoint, and SQL Server are either registered trademarks or trademarks of Microsoft Corporation in the United States and/or other countries.

LaserJet, DesignJet, HP, HP-GL and HP-GL/2 are either registered trademarks or trademarks of Hewlett Packard in the United States and/or other countries.

WildFly is either a registered trademark or trademark of Red Hat Inc. in the United States and/or other countries.

Chrome is either a registered trademark or trademark of Google LLC in the United States and/or other countries.

Firefox is either a registered trademark or trademark of Mozilla Foundation in the United States and/or other countries.

Intel and Xeon are either registered trademarks or trademarks of Intel Corporation in the United States and/or other countries.

Oracle JSP, and Java are either registered trademarks or trademarks of Oracle Corporation in the United States and/or other countries.

Patents

The products described in this documentation are protected by Patent Nos.: US 6,182,127 B1; US 6,510,459; US 7,185,069; US 7,647,373 and corresponding foreign patents. Patents pending.

Third Party Software

This product contains certain third party software components. The components are provided in accordance with their licenses. See the *Third Party Software Notices* document for more information.

About This Guide

What is in this Guide?

This section describes the layout of the Enterprise User's Guide. This guide contains the following.

- Contents outlines the chapters and topics within this manual.
- Part I: Introduction describes DigitalPaper XE capabilities, how the product works, who uses it, as well as an overview of Enterprise User functions and the DigitalPaper XE interface.
- Part II: Quick Tour provides examples of how to use the DigitalPaper XE to search, view, annotate and print documents, as well as how to create document packages, distribute them to your Trading Partners, and collaborate on documents.
- Part III: Reference provides a detailed description of the interfaces used to search, annotate, package, print and download documents.
- Part IV: Appendices contains a complete description of DigitalPaper XE support policies along with a Glossary containing a list of commonly used terms and definitions. It also contains information about supported document file types.

Using PDF Files

All DigitalPaper XE documents are formatted in Portable Document Format (PDF) files. Viewing PDF files require an appropriate document reader.





Send Us Your Comments



















ePlus Inc. welcomes your feedback on the usefulness of this documentation. Please send all comments via electronic mail to dpsupport@eplus.com When giving feedback, please provide the following information:

Your name	Manual title, version number, and date
Company name	Relevant concepts or examples
Phone number	Chapter, section and page number

Contents

Patent and Legal Notices	2
WARNING	2
Trademarks	2
Patents	2
Third Party Software	2
About This Guide	3
Using PDF Files	3
Send Us Your Comments	3
DigitalPaper XE Features	15
Document Import and Index	15
Document Search, View, and Download	16
Document Markup	16
Document Packages	16
Bill of Materials	17
Document Print	17
DigitalPaper XE Roles	17
Administrator	17
Anonymous User	17
Application Configuration Specialist	18
Indexing Specialist	18
Enterprise User	18
BoM Administrator	18
DocPak Administrator	18
DocPak Administrator Recipient	18
Watermark Administrator	19
Trading Partner	19
Searching for Documents	20
Viewing a Retrieved Document	21
Annotating a Document	21
Creating and Viewing DocPaks	22
Publishing a DocPak	22
Import a DocPak	23
Interface Overview	23
Page Layout	23
Primary Navigation Bar	24
Page Bar	25

Option Bar	25
Content Area	25
Page Navigation Options	26
Access DigitalPaper XE	29
Update Your Profile	30
Download the DP Print Helper Application	32
Search for Documents	33
Search Examples	34
Method 1: Search for all Documents	34
Method 2: Perform a Refined Search	35
Options from the Search Results Page	37
View a Document's Image	38
Navigate an Image in the Viewer	39
Panning	39
Panning: Method 1	39
Panning: Method 2	41
Bird's Eye View	41
Zoom to a Selected Area	43
Copy a Portion of a Document to a File Outside of DigitalPaper XE	44
Print a Selected Area	45
Print the Entire Document	45
Download a Document	46
View Additional Documents	46
DPXE Viewer	46
Main Window	46
Control Groups	47
Bird's Eye View	49
Old Revisions (Not Current Documents)	50
Mouse-Based Navigation	52
Zoom In	52
Zoom Out	53
Pan	54
Menu Function Navigation	55
Go to a page within the document 	55
Go to a document in the search result set 	56
Go back to the search results page 	58
Begin a new search 	59
Go to the XE home page 	60

Go to the XE Viewer help page ?	60
Document Function Navigation	63
Show the document's properties 	63
Download the document 	64
Print the document 	65
Toggle the Bird's Eye View 	66
View the document in the classic viewer 	67
Page View Controls	68
View the previous page in the document 	68
View the next page in the document 	69
Zoom in 	70
Zoom out 	71
Fit to page 	72
Fit height 	73
Fit width 	74
Reset view 	75
View/Set Zoom Level <input type="text" value="Zoom to 13"/> % <input type="button" value="Go"/>	76
Document View Controls	77
View the next document in the search results set 	78
Rotate the view 90 degrees 	79
Select a region of the image 	80
Zoom to the selected region 	81
Copy the selected region to the clipboard 	82
Print the selected region 	84
View/Set page to display <input type="text" value="Go to page 1"/> <input type="button" value="Go"/>	85
ViewMark Controls	86
Annotate a Document	88
Add a Text Annotation	89
Add a Circle Annotation	90
Add a Rectangle Annotation	91
Highlight an Area	93
Add an Arrow Annotation	94
Add a Highlighted Note	96
Hide and/or Delete ViewMark Annotations	97
Save a ViewMark	98
Save a New ViewMark	98
Send a ViewMark to Another User	99

Receive a ViewMark	101
Load a ViewMark	101
Update a Document with Previously Saved ViewMarks	102
Print a ViewMark	103
View Document Properties	103
View a Document's Revision History	104
Obtain a ViewMark History	104
Printing a Document	106
Check Print Job Status	108
Cancel a Print Job	109
Download a Document	109
Create a DocPak	111
Add Documents to a DocPak	113
Add Line Items to a DocPak	116
Add Documents to the Line Item	117
Add Attachments to a DocPak	119
DocPak and Line Item Options	119
Publish a DocPak	123
Import a DocPak	130
Receive a DocPak	136
View a Received DocPak	136
Method 1: Access a Received DocPak from E-mail Notification Message	136
Method 2: View Received DocPaks List	137
View Received DocPak Contents	137
View Received DocPak Updates	139
View Public DocPaks	141
Print and Download a DocPak	141
Search for Documents within a DocPak	147
Search for Documents within a Specific Line Item	147
Search for DocPak Updates	148
Search for DocPaks	149
Edit DocPaks	150
Modify a Saved DocPak	150
Modifying DocPak or Line Item Header Information	150
Expiring DocPaks	151
Activating DocPaks	152
Delete Documents from a DocPak or Line Item	152
Delete a Line Item Folder	153
Copy a DocPak	154

Delete an Entire DocPak	155
Document Search Tools	158
Search for Documents Page	158
Search Options	160
Document Search Results Page	161
Document Search Results Page Bar	161
Search Results Option Bar	162
Search Results Content Area	162
Document Cart	163
Document Viewer	163
Annotation Tools (ViewMark)	163
Document Properties	163
Bill of Materials Features	164
The Bill of Materials Interface	164
Search for Bills of Materials	165
Print a Bill of Materials	166
Download a Bill of Materials	166
View a Bill of Materials	166
Page Bar Tasks	167
Copy Bill of Materials	167
Back to Search Results	167
Bill of Materials Navigator	167
Show Bill of Materials Properties	168
Show All Parts	168
Navigate a Bill of Materials	168
Right Click Context Menu	168
Searching for documents within a Bill of Materials	169
Bill of Materials Options Bar Tasks	170
Where Used Search Icon	170
My DocPaks Tools	172
My DocPaks Main Page	172
My DocPaks Page Bar	173
My DocPaks Option Bar	173
My DocPaks Content Area	173
Column Sorting	174
My DocPaks (Single DocPak)	174
My DocPaks (Single DocPak) Page Bar	175
My DocPaks (Single DocPak) Content Area	176
My DocPak Name Page	176

DocPak Header tab	176
DocPak Documents tab.....	178
Documents tab option bar	178
Documents tab content area	179
My DocPaks Updates Page.....	179
Pending tab	179
Pending tab option bar	180
Pending tab content area.....	180
History tab.....	181
History tab content area	181
Search DocPak Updates	181
Search DocPak Updates Criteria Page.....	182
Search for Documents Within a DocPak	182
Search for Documents within a Specific Line Item.....	183
Recipients.....	184
Recipients pane option bar	184
Recipients pane content area	184
Add Recipients from: Users.....	184
Users tab option bar	185
Users tab content area.....	185
Add to Recipients from: Groups.....	186
Groups tab option bar.....	186
Groups tab content area	186
Line Items Main Page.....	187
Line Items Page (Single Line Item)	187
Add documents to Line Item from <i>Cabinet</i>	187
Add documents to Line Item from the Document Cart	188
Line Item Header tab	188
Line Item Documents tab.....	188
Line Item Documents tab option bar	189
Line Item Documents tab content area	189
Attachments Main Page.....	189
Attachments Option Bar	190
Attachments content area	190
Attachments Page (Single Attachment)	190
Copy DocPak URL to Clipboard	191
Received DocPaks Pages	192
Public DocPaks Pages.....	192
Create DocPak and Line Items Tools.....	192

Create DocPak Page	192
Create Line Items	193
Create Attachments	194
Import DocPak Pages	194
DocPak Import File Formats	194
Import DocPak Page 1	195
Import DocPak Page 2	196
Search DocPaks Page	197
DocPak Search Results Page	199
Download a DocPak Index	199
Document Cart Overview	201
Document Cart Functions	201
Document Cart Page Bar	201
Document Cart Option Bar	202
Document Cart Content Area	202
Sort Documents in the Cart	202
Options Menu	204
Update Your Profile	204
Update Your Preferences	205
Check Print Job Status	206
Download the DP Print Helper Application	206
Help Menu	207
Logout Menu	207
Print Options	208
Printer Options Page	208
Common Print Options	209
ViewMark Options	210
Local Printing	210
Print Stamps	210
Watermarks	210
Print Job Status	211
Print Job Status Page Bar	211
Print Job Status Option Bar	211
Print Job Status Content Area	211
About DPPrint	211
Classic Document Viewer	214
Single Page Document	214
Multi-page Documents	215
Page List (left pane)	216

Viewer Window (right pane).....	216
Viewer Functions	217
Viewer Frame (Top)	217
Viewer Frame (Left)	218
Viewer Frame (Bottom)	219
Viewer Frame (Right)	220
Viewer Frame (Corners).....	220
Annotation Tools (ViewMark).....	220
Create ViewMark Toolbar	221
Load ViewMark Menu.....	224
Save ViewMark	225
Send a ViewMark via E-mail.....	226
Supported Document Import File Types	228
Standard Import File Types (Converted to TIFF)	228
CSV Files	228
CAD/PDM Files	229
Creating Print Files from CAD/PDM Systems	229
Native File Types	229
DocPak Import File Type	230
ePlus Support	231
Support Programs	231
Standard Product Support Program.....	231
Platinum Product Support Program.....	231
Customized Product Support Program	232
Support Resources	232
Training	232
Knowledgebase.....	232
Web Interface Support.....	233
E-mail Support.....	233
Telephone	233
Fax Support	234
Glossary.....	235
Administrator	235
Application Configuration Specialist	235
Attribute.....	235
Bird's Eye View	235
Cabinet	235
DirectSight.....	235
<i>DocPak</i>	236

Document	236
DPPrint.exe	236
Enterprise User	236
Index Specialist	236
Revision Level.....	237
Stamping	237
Trading Partner	237
ViewMark.....	237
XE Server	237

Part I

Introduction

Chapter 1

Product Overview

Welcome to DigitalPaper XE®, a web-based solution that improves customers' business performance by enabling fast, secure access to and collaboration of mission critical documents over the Internet. By replacing paper-based systems and ineffective file transfer technologies, the Digital Paper solution shortens operating cycles and slashes hard dollar costs in a short period of time. Organizations use DigitalPaper XE to retain the benefits of paper while eliminating its drawbacks. DigitalPaper XE lets you:

- store technical documents (e.g., engineering drawings, manuals, field service tickets, purchase orders) in an online repository, thus eliminating the need for paper copies or microfilm aperture cards.
- provide internal and remote employees, business partners, customers and suppliers with secure and timely access to the latest versions of technical documents.
- assemble and publish multiple documents as a business package (e.g., RFP/RFQs, work orders) with a click of a button, replacing the costly and time consuming process associated with paper production and shipping.
- streamline collaboration through the electronic exchange of document markups (e.g., text, manual drawings) for the purpose of asking questions and making clarifications, without affecting or copying the original document.
- synchronize published content by automatically sending business package recipients change notification e-mails that contain hyperlinks to revised document(s).

Authorized users and recipients of DigitalPaper XE documents and business packages need only a standard web browser to search, view, email, annotate, print and download the correct version of documents, regardless of file size or complexity. Who are these authorized users and recipients? As the figure below demonstrates, DigitalPaper XE supports large and dispersed user communities both within and outside the enterprise such as:

- globally dispersed buyers and suppliers in sourcing.
- quality assurance, shop floor workers, and contract manufacturers in manufacturing.
- dispatchers, remote workers, customers, dealers and third party field service providers in field service.
- service technicians, supervisors, spare parts buyers and suppliers in maintenance and repair operations.

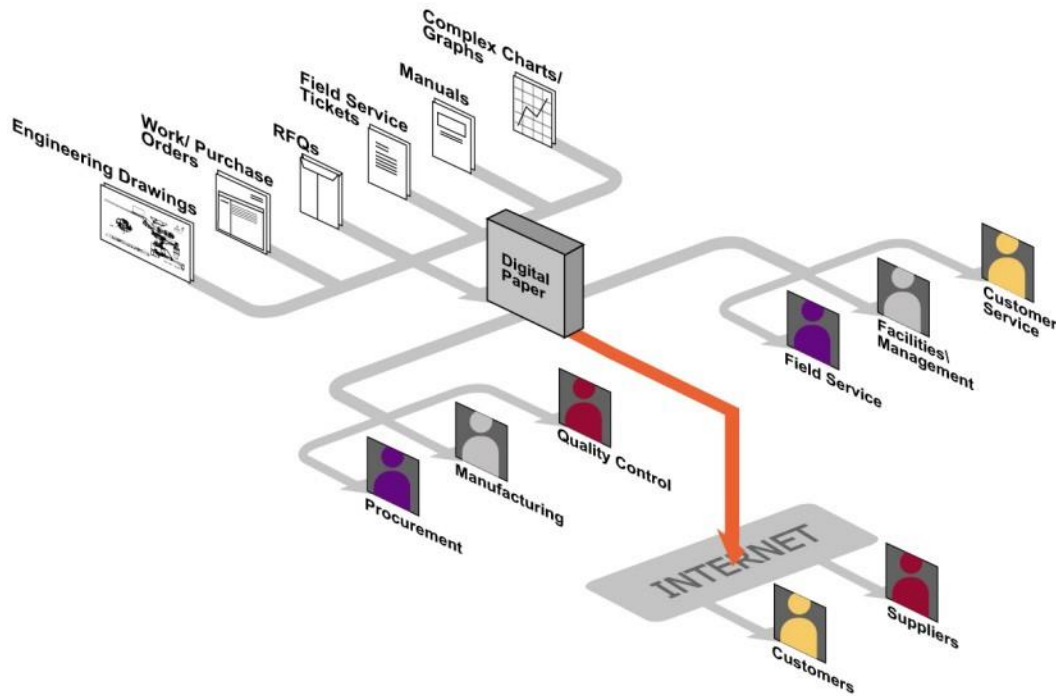

Figure 1.1: The DigitalPaper XE solution

DigitalPaper XE Features

This section describes at a high level the features DigitalPaper XE provides as well as how these features work.

Document Import and Index

Documents are digitized and then imported from external sources such as CD-ROM, local drives, or network directories, into a temporary location in the DigitalPaper XE system, referred to as a “workspace”. Documents held in a workspace cannot be accessed by general users until they have been indexed and released to the repository. The index process presents a highly structured way for users to search and locate documents (e.g., by document name, number, revision). When ready for general consumption, most documents are “released” to virtual file cabinets in the repository. These cabinets provide a logical grouping of documents and can only be accessed and viewed by users with the appropriate permissions.

Files imported into the system are stored as TIFF, in their native format (i.e., original format), or both as follows:

- Files that may be converted to TIFF so they can be viewed within the DigitalPaper XE Viewer include: PDF, PostScript, some CAD/PDM files, and popular spreadsheet, word processing, and presentation files.
- Files that are imported in their native format and can also be displayed in the DigitalPaper XE Viewer (without being converted) include: BMP, GIF, JPEG, PNG, PDF, and TIFF.
- File types that cannot be displayed within the DigitalPaper XE Viewer are stored in their native format where they are available for download.
- If desired, the Administrator can elect to import the native version of the file with its TIFF counterpart (if any), allowing the user to display the document in the Viewer and/or download the file in its native format.

Document Search, View, and Download

DigitalPaper XE's powerful search engine is used to find documents within cabinets based on the attributes assigned to them during the import and index process. When a document is requested to be viewed, and the Viewer supports the file type, the document is presented to the browser for display using ePlus inc.'s patented DirectSight™ technology.

Documents can also be downloaded to the user's workstation as a single TIFF image or a multi-document zip file depending on the number of documents. DigitalPaper XE determines the content type of a single document being downloaded and automatically launches the application associated with the file if the user's browser is configured properly. If multiple documents are compressed into a zip file, the user will have to run compression software to decompress the files for use.

Document Markup

Users communicate changes, questions, or exchange ideas about a document using ePlus inc.'s patented ViewMark® URL-based markup technology. Without the use of applets or plug-ins, geographically dispersed users collaborate on digital content by overlaying graphics or text comments on a document without affecting the source file. For example, if a user draws a rectangle on a document, a URL request is sent to the server which tells the engine what to create. The coordinates of the rectangle are stored as a separate record, and a hyperlink to the original document and corresponding ViewMark is created. This hyperlink can be sent to other users using an integrated e-mail gateway. Document recipients can view the marked up document in a web browser, provide their own set of ViewMarks with comments or responses, and reply without ever having to download any files. The collaboration history is retained by the system.

Document Packages

DigitalPaper XE also supports the immediate assembly of multiple documents stored in the repository into a comprehensive business package, called a DocPak®. Examples of DocPaks include RFPs, RFQs, ECNs, and Work Orders. DocPaks can be saved, searched, downloaded, printed, or published to a restricted set of users or made "public" to all users with read and/or write DocPak privileges.

DocPaks can either be created manually by the Enterprise User or imported by the Application Configuration Specialist using XML files generated by automation systems external to DigitalPaper XE. To manually create a DocPak, the Enterprise User searches the repository for the desired documents, then simply points and clicks each document to include in the DocPak. If desired, the DocPak creator can organize documents within the DocPak hierarchically through the use of Line Items. A Line Item is a logical grouping of related documents within a DocPak. For example, if a DocPak contains the documents associated with building a car, one line item can contain the documents associated with assembling the front bumper, while another line item contains the documents related to the wheel assembly. Once a DocPak's structure and contents have been defined, the creator specifies which recipients will receive access to the DocPak and the date they may have access. In addition, DocPaks can be nested within DocPaks.

To streamline the DocPak creation process, DigitalPaper XE can also import XML files that define each DocPak's parameters (e.g., name, description, documents to include, recipients, publication date). There are two DocPak import methods available: manual and scheduled. The manual import approach allows the Enterprise User to use the web interface to browse for the XML file of choice, import the file, then review and optionally edit the DocPak if its definition, structure or contents require changes. The system can also be configured by the Application Configuration Specialist, via an import profile, to automatically and routinely poll specified directories for the XML files. The scheduled approach was designed so that multiple DocPaks may be imported and subsequently published automatically, without requiring the use of DigitalPaper XE's web interface.

Once a DocPak has been published, recipients click a hyperlink within an email notification or simply log in to DigitalPaper XE to view the DocPak. DocPak publishers can also view a list of DocPaks they have created. If a document within a DocPak is modified, DigitalPaper XE's revision logic tracks the changes and automatically sends (if desired) a change notification to both DocPak creators and recipients with a hyperlink to the latest version of the document, thus ensuring all parties are

working with the same set of materials. If a DocPak is defined to have public access by the creator, anyone with the ability to create and/or view DocPaks may view its contents.

Bill of Materials

DigitalPaper XE supports the importation of a Bill of Materials (BOM) part structure providing a hierarchical tree representation with the ability to link the part structure to documents contained within the repository. An API exists to allow custom integrations with external systems (PDM, MRP) used to manage Bills of Materials. A BOM or sub-assembly sections of a BOM can be exported to DocPaks and the documents contained in a BOM can be printed and downloaded.

After a document has been associated with a part in a BOM, an icon appears with that document that will link to the BOM interface, providing a 'where used' search capability.

As with DocPaks, a full range of search options are provided to quickly locate a particular BOM, or to locate specific documents within a BOM.

Document Print

If a hard copy is required, users can print documents stored in DigitalPaper XE to a broad range of popular printers. Users can print a document and its markups as well as the entire (or selected) contents of a DocPak with 100% fidelity and at the same resolution of the image on any size paper. Users can configure the print job based on the target printer and include print stamps (e.g., date, time) and watermarks (i.e., faint text that appears in the background such as copyright information, company name).

DigitalPaper XE Roles

Users of DigitalPaper XE are categorized by their role in the system as described below.

Administrator

Typically an employee in the enterprise's IT department who has comprehensive knowledge of computer and networking systems, the Administrator is responsible for keeping the system online, performing system maintenance, installing software patches and monitoring system performance. Duties specific to DigitalPaper XE include configuring the system's security for the users and groups that can access the application as well as defining the privileges associated with each role described in this section. An Administrator is also responsible for setting up printers, applying system-wide settings and other utility functions. The Administrator user is automatically created by the system and is given both administration and application configuration capabilities by default.

Anonymous User

The Anonymous user is a specialized version of the "Trading Partner" role. The role of Anonymous user can be assigned to all unauthenticated users that access the DigitalPaper XE system. The DigitalPaper XE system requires authentication by default through a login username and password, but may be configured to permit unauthenticated access (i.e., no login username or password required). If it is desired that the Anonymous user be able to search cabinets for documents or have the ability to publish DocPaks for general availability in an intranet setting and/or on the Internet, the Anonymous user may be reassigned to the "Enterprise User" role described below.

Application Configuration Specialist

An Application Configuration Specialist is typically a member of an organization's IT department who is responsible for configuring DigitalPaper XE and has comprehensive knowledge of computer and networking systems. The Application Configuration Specialist is responsible for structuring the system to influence how the users interact with it. Responsibilities include defining how documents are imported into the system, the workspaces used to index and release documents to the repository, the virtual file cabinets where documents are referenced, and the templates available to Enterprise Users to create DocPaks and their associated Line Items. In addition, the Application Configuration Specialist has the ability to search and update attribute(s) associated with multiple documents, and configure the system to automatically import and publish DocPaks based on XML files generated by external automation systems.

Indexing Specialist

The Indexing Specialist is an enterprise employee whose role is to assign searchable attributes (e.g., document name, description, revision number) to each document, modify documents with a raster editor, then "release" documents into virtual filing cabinets of the DigitalPaper XE repository. The Indexing Specialist is most often a member of an organization's Document Control staff, responsible for making sure their "customers" can get the right documents when needed.

Enterprise User

Enterprise Users are typically internal or remote employees who are allowed to search for documents located in the DigitalPaper XE repository. If the Enterprise User has access to the cabinets in which these documents reside, a list of documents matching the search criteria is returned. Each document can be viewed, annotated, printed, downloaded, and sent to other Enterprise Users or Trading Partners. Enterprise Users can also manually assemble multiple documents and publish the collection as a DocPak or import DocPaks via an XML file.

BoM Administrator

All EnterpriseUsers may access the Bill of Materials interface once it is enabled. However, in order to delete a Bill of Materials, the user must be a member of the BoM Administrator role to perform that operation.

DocPak Administrator

The DocPak Administrator role provides the same access rights/privileges as the creator (Enterprise User) of a DocPak, but for all DocPaks in the system.

DocPak Administrator Recipient

The DocPak Administrator Recipient role is similar to that of the DocPak Administrator in that it provides the same access rights/privileges as the creator (Enterprise User) of a DocPak. However, for a DocPak Administrator, these creator privileges apply to all DocPaks in the system whereas for a DocPak Administrator Recipient, these privileges only apply to DocPaks for which the user is also a recipient.

Watermark Administrator

Users in the Watermark Administrator role are able to bypass the application of Advanced Document Stamping and Personalization when documents are viewed, downloaded, and/or printed.

For more information about the Advanced Document Stamping and Personalization feature, please see *Advanced Document Stamping and Personalization (ADSP)* in the *Administration and Application Configuration Guide*.

Trading Partner

Trading Partners normally include the enterprise customers, suppliers, and business partners who receive DigitalPaper XE documents. Trading Partners are notified via e-mail if they have received access to a document or DocPak. Document access is as easy as clicking a URL embedded within the email and logging into the system. Trading Partners can view, download, and print documents they have received. If Trading Partners have a question on a document, they can also mark up the documents without affecting the original document and send these comments to the person who sent the document or DocPak.

Chapter 2

Using DigitalPaper XE

This chapter provides an overview of the major tasks performed by an Enterprise User in the following sections:

- *Searching for Documents.*
- *Viewing a Retrieved Document.*
- *Annotating a Document.*
- *Creating and Viewing DocPaks.*

This chapter also describes the interface used to perform these tasks in *Interface Overview*.

Searching for Documents

DigitalPaper XE's search tool allows Enterprise Users to locate documents within the repository. Searches can be conducted by cabinet and by document attributes such as document name or number; searchable attributes may vary from one cabinet to the next. General searches can be conducted for all documents across all cabinets or by a specific cabinet. More refined searches can be conducted using a combination of document attributes that includes wild cards.

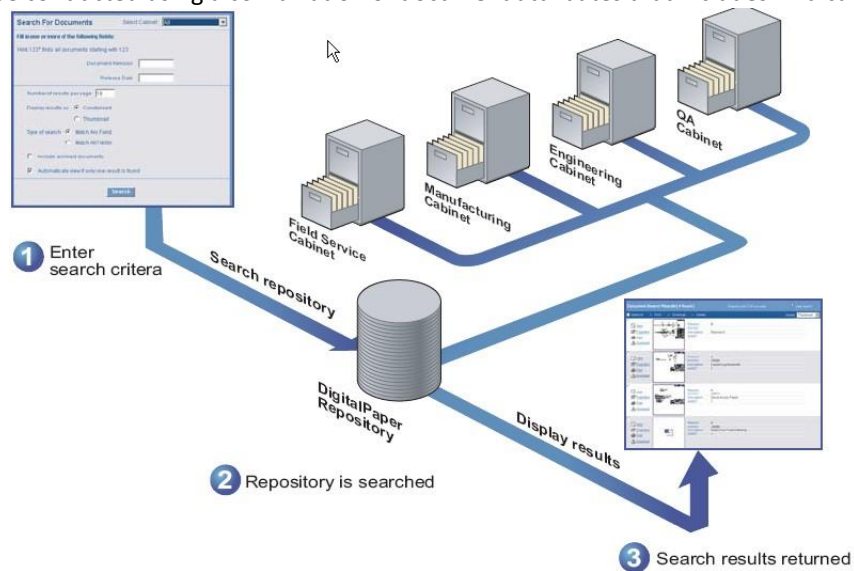

Figure 2.1: Search for documents

To search for a document, an Enterprise User does the following in DigitalPaper XE's "Search for Documents" page:

- Enters the number of results to be displayed.
- Selects whether or not the documents should be displayed with a thumbnail image.
- Chooses whether or not a single document result should be displayed in DigitalPaper XE's viewing tool.
- When the search is submitted, the repository is searched based on the criteria entered.

- Multiple documents found are displayed in a search results list. This list contains each document's attributes, and if selected, a thumbnail sketch of each document. These documents can be printed, downloaded, viewed, or assembled into DocPaks.

A single document may also be displayed in the search results list, or displayed in the viewing tool according to the criteria entered in the "Search for Documents" page.

Viewing a Retrieved Document

DigitalPaper XE's integrated viewing tool is a convenient way to view an entire document or portions of a document.

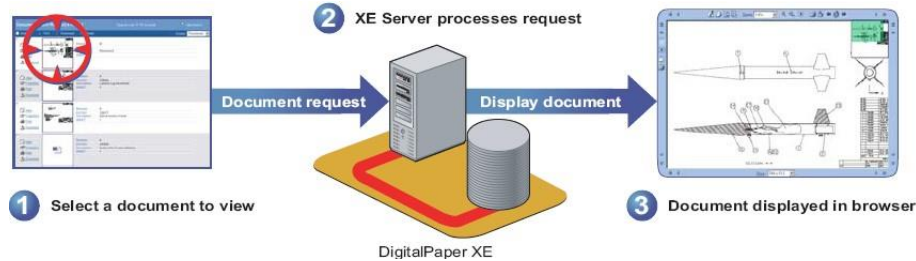

Figure 2.2: View a document

Click the appropriate link within the search results page or within a DocPak to view a document.

- The XE Server processes the request.
- The XE Server retrieves the document and sends it to the browser for display. The viewing tool includes the control buttons to manipulate the document view (e.g. *zoom*, *pan*), mark the document (as described in *Annotating a Document*), or print and distribute the document.

Annotating a Document

Using DigitalPaper XE's ViewMark capabilities, the Enterprise User can markup a document by overlaying graphics (e.g., rectangle, circle, arrow), text or highlights to indicate an area of a document that needs to be changed and then communicate that change to another user. For example, a procurement officer may annotate a drawing and then send a link to the marked up document via e-mail to an engineer for verification. Adding a ViewMark to a drawing does not change the document stored in the repository but is a powerful tool to draw attention to changes or to add comments.

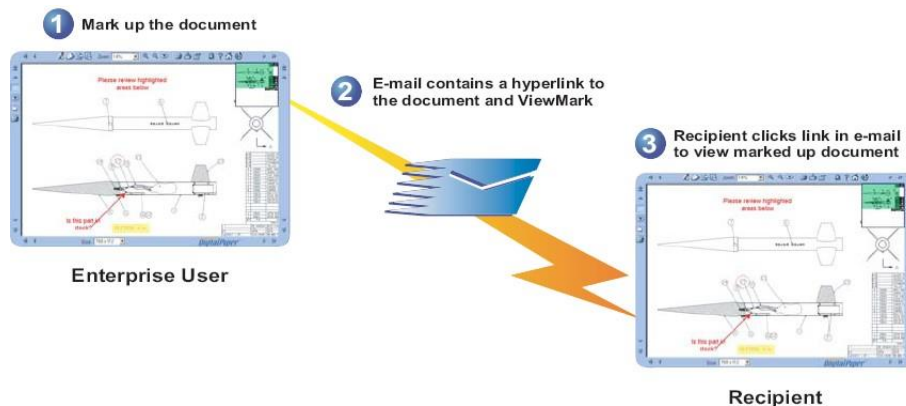

Figure 2.3: Mark up a document

With the document displayed in the DigitalPaper XE Viewer, the Enterprise User annotates the document as desired. These mark ups can be loaded via the URL that is e-mailed to other Enterprise Users or Trading Partners.

Note

ViewMarks can also be printed or sent with documents contained within a DocPak.

The ViewMark recipient displays the document containing the ViewMarks within a browser. The ViewMark recipient can print or create his/her own markups and send them to the ViewMark sender using the same process.

Creating and Viewing DocPaks

Enterprise Users can create a logical grouping of documents for the purpose of distribution to other Enterprise Users or Trading Partners. Enterprise Users can access or view a current list of the DocPaks they have created and received, as well as those which have been made "public". In addition, searches can be performed for all DocPaks stored in the repository. DocPaks can be published via an e-mail hyperlink, printed or downloaded at any time. If a change occurs to one of the documents within any DocPak, the creator and recipient are immediately notified of the change via e-mail.

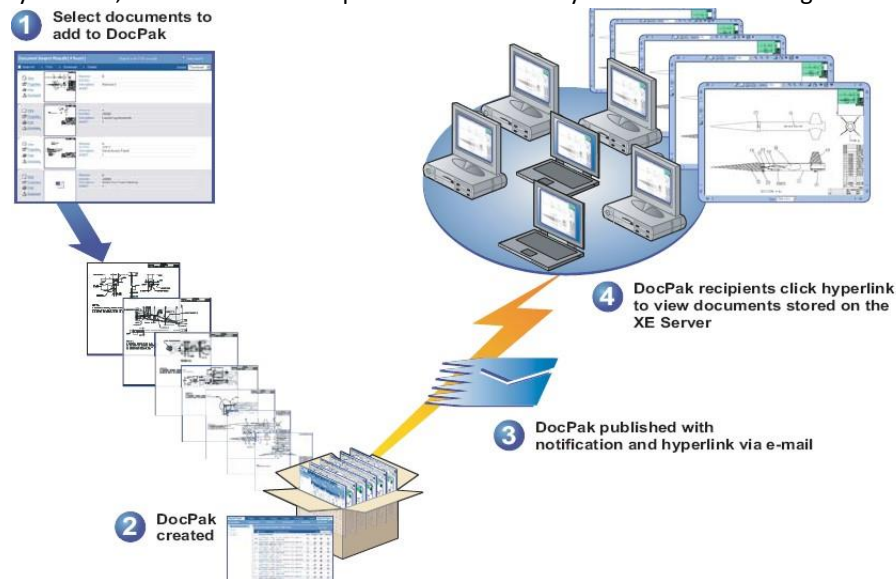

Figure 2.4: Create and publish a DocPak

Publishing a DocPak

The steps below describe the DocPak publishing process.

1. Multiple documents are selected from the "Search for Documents" page or from within a user's Document Cart. Once the documents are selected, the Enterprise User chooses to create the DocPak.
2. Through the use of templates (e.g., RFQ, RFP) that standardize the appearance of the package received by DocPak recipients, the Enterprise User defines the DocPak attributes (e.g., name, description expiration date), views the documents within the DocPak, and optionally adds Line Items and/or Attachments that allow for the organization of documents within the DocPak.
3. When the contents of the DocPak have been finalized, the Enterprise User selects the recipients from a list of contacts; the DocPak is published as a hyperlink within an e-mail notification.

As an alternative to restricting DocPak access to specific recipients, DocPaks can be made "public" (i.e., access is granted to any user with the ability to log in as an Enterprise User). Since Public DocPaks do not require recipients, no e-mail notifications are sent upon publication or document modification.

If DocPak access is restricted to a specific set of users, the DocPak recipients receive the e-mail and click the link within it to log in to DigitalPaper XE. Once logged in, DocPak recipients are provided with a "Received DocPaks" interface that lists all DocPaks they have received to date, displays a summary of each DocPak, and lets them view the documents within each DocPak. In addition to viewing the documents, DocPak recipients may also mark them up, print them, or download them from the XE Server to their own computer, given the appropriate permissions.

If DocPak access is "public," any Enterprise User may use the "Public DocPaks" interface to view the DocPak's contents. The rules governing this type of DocPak are the same as Received DocPaks except Public DocPaks do not require recipients to be assigned to it when published. In this case, e-mail change notifications will only be sent to the DocPak creator.

For more information on publishing DocPaks, see *Assembling and Receiving Business Packages*.

Import a DocPak

In addition to the manual publishing process described in the section above, the DocPak creator can import an XML file that delineates the DocPak's contents. DocPaks can also be generated and published automatically as determined by the Application Configuration Specialist. For more information, see *Import a DocPak*.

Interface Overview

The DigitalPaper XE browser-based interface is intuitive and easy to navigate. This section describes how the DigitalPaper XE interface is used to perform the tasks described in the sections above.

Page Layout

All pages have a primary navigation bar for site-level navigation. The navigational elements in the top bar are dependent on your role in the system as determined by the system administrator. Most, but not all pages, have a page bar directly below the primary navigation bar and an option bar followed by the content area. The figure below provides a sample of DigitalPaper XE's general site layout.

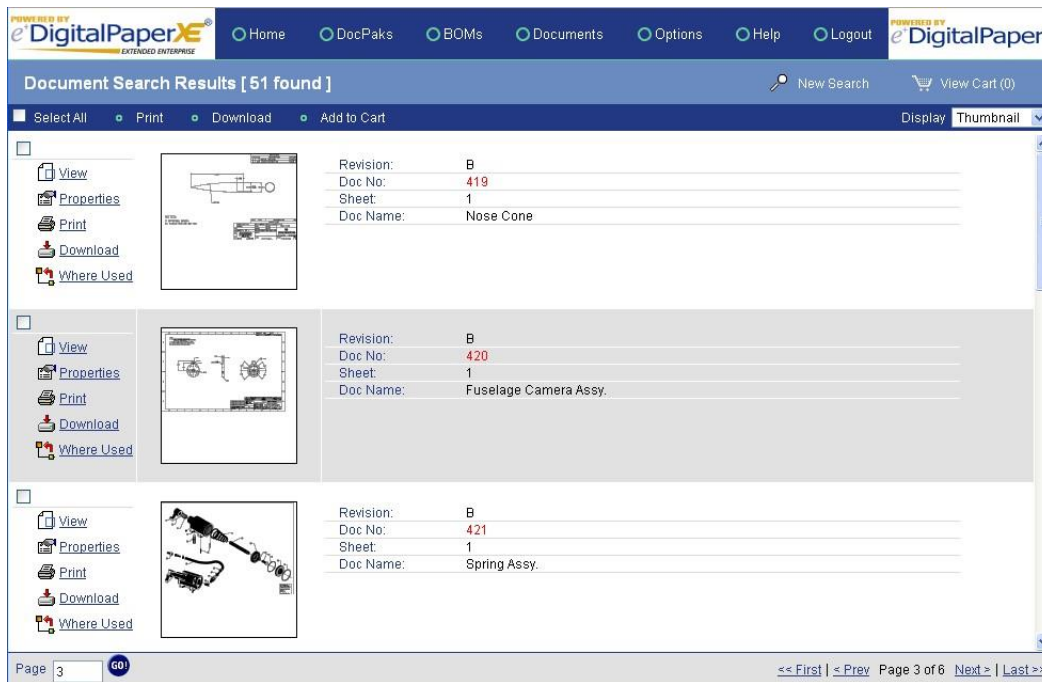

Figure 2.5: General page layout

Primary Navigation Bar

The top of every page in the application contains a navigation bar which is used to locate the functions you are interested in performing.



Figure 2.6: Primary navigation bar

The default options available to Enterprise Users are as follows:

- **Home** – Displays the DigitalPaper XE home page with the DigitalPaper XE logo (or your company's logo), and copyright information. With the exception of the navigation bar, the remainder of the home page can be customized by the system administrator.
- **DocPaks** – Displays "My DocPaks" page (by default) with all the DocPaks you have created, or the "Received DocPaks" page if that was the most recent DocPak page you had displayed during the session. For more information, see *Assembling and Receiving Business Packages*.
- **BOMs** – Displays the "Bill of Materials" page. This option is only available if BOM functionality has been activated by the administrator. For more information, see *Bill of Materials*.
- **Documents** – Displays the "Search for Documents" page described in *Search for Documents*.
- **Help** – Displays the *Enterprise User's Guide* in PDF format.
- **Options** – Allows you to update your account information or check print job status.
- **My Profile** – Displays a page that allows you to update your own account information, including password, name, and e-mail address.
- **Logout** – Closes the current session and returns you to the User Login page. To enter the system, you must log in again.

Page Bar

Some DigitalPaper XE pages contain a page bar containing page-specific labels, navigational elements, and controls. An example of a page bar is displayed below.



Figure 2.7: My DocPaks page bar example

The options available on the page bar are addressed in detail in the chapters relevant to each applicable page.

Option Bar

Some DigitalPaper XE pages that display lists of items such as documents and DocPaks contain an option bar that allows for selection of all list items, as well as to perform actions such as print, download, or delete a selected item.

Document Search Results [23 found]				New Search	
<input type="checkbox"/> Select All <input type="checkbox"/> Print <input type="checkbox"/> Download <input type="checkbox"/> Add to Line Item			Display: Condensed		
Document Attributes	Revision	View	Properties		
<input type="checkbox"/> Doc Name: NKE Smoke Assembly Doc No (P/N): 25670 Model: NKE Smoke Type: Manufacturing Related Site: www.nkesmoke.com	C				
<input type="checkbox"/> Doc Name: BT60 Body Tube Doc No (P/N): 25671 Model: NKE Smoke Type: Manufacturing Related Site: www.nkesmoke.com	A				
<input type="checkbox"/> Doc Name: Engine Hook Doc No (P/N): 25675 Model: NKE Smoke Type: Manufacturing Related Site: www.nkesmoke.com	A				
<input type="checkbox"/> Doc Name: Decal (United States) Doc No (P/N): 25676 Model: NKE Smoke Type: Manufacturing Related Site: www.nkesmoke.com	A				
<input type="checkbox"/> Doc Name: Decal (Access Panel) Doc No (P/N): 25677 Model: NKE Smoke Type: Manufacturing Related Site: www.nkesmoke.com	A				
<input type="checkbox"/> Doc Name: BT60 Nose Cone Doc No (P/N): 25678 Model: NKE Smoke Type: Manufacturing Related Site: www.nkesmoke.com	A				
<input type="checkbox"/> Doc Name: Med Screw Eye Doc No (P/N): 25679 Model: NKE Smoke Type: Manufacturing Related Site: www.nkesmoke.com	A				
<input type="checkbox"/> Doc Name: Launch Lug Doc No (P/N): 25681 Model: NKE Smoke Type: Manufacturing Related Site: www.nkesmoke.com	B				
<input type="checkbox"/> Doc Name: Shock Cord Mount Doc No (P/N): 25682 Model: NKE Smoke Type: Manufacturing Related Site: www.nkesmoke.com	A				
<input type="checkbox"/> Doc Name: Parachute Sub Assembly Doc No (P/N): 25683 Model: NKE Smoke Type: Manufacturing Related Site: www.nkesmoke.com	A				

Figure 2.8: Sample option bar

The options available in the option bar are addressed in detail in the chapters relevant to each applicable page.

Note

The "Select All" option applies to the currently displayed content area, not to any subsequent page (if more than one).

Content Area

This area displays document search results, DocPak lists, forms, or the contents of a selected object (e.g., document properties, DocPak contents). The example below displays documents search results in "Condensed" mode (as opposed to the "Thumbnail" mode displayed in *General page layout*)

Document Search Results [23 found]				New Search	
<input type="checkbox"/> Select All <input type="checkbox"/> Print <input type="checkbox"/> Download <input type="checkbox"/> Add to Line Item				Display Condensed	
Document Attributes	Revision	View	Properties		
<input type="checkbox"/> Doc Name: NKE Smoke Assembly Doc No (P/N): 25670 Model: NKE Smoke Type: Manufacturing Related Site: www.nkesmoke.com	C				
<input type="checkbox"/> Doc Name: BT60 Body Tube Doc No (P/N): 25671 Model: NKE Smoke Type: Manufacturing Related Site: www.nkesmoke.com	A				
<input type="checkbox"/> Doc Name: Engine Hook Doc No (P/N): 25675 Model: NKE Smoke Type: Manufacturing Related Site: www.nkesmoke.com	A				
<input type="checkbox"/> Doc Name: Decal (United States) Doc No (P/N): 25676 Model: NKE Smoke Type: Manufacturing Related Site: www.nkesmoke.com	A				
<input type="checkbox"/> Doc Name: Decal (Access Panel) Doc No (P/N): 25677 Model: NKE Smoke Type: Manufacturing Related Site: www.nkesmoke.com	A				
<input type="checkbox"/> Doc Name: BT60 Nose Cone Doc No (P/N): 25678 Model: NKE Smoke Type: Manufacturing Related Site: www.nkesmoke.com	A				
<input type="checkbox"/> Doc Name: Med Screw Eye Doc No (P/N): 25679 Model: NKE Smoke Type: Manufacturing Related Site: www.nkesmoke.com	A				
<input type="checkbox"/> Doc Name: Launch Lug Doc No (P/N): 25681 Model: NKE Smoke Type: Manufacturing Related Site: www.nkesmoke.com	B				
<input type="checkbox"/> Doc Name: Shock Cord Mount Doc No (P/N): 25682 Model: NKE Smoke Type: Manufacturing Related Site: www.nkesmoke.com	A				
<input type="checkbox"/> Doc Name: Parachute Sub Assembly Doc No (P/N): 25683 Model: NKE Smoke Type: Manufacturing Related Site: www.nkesmoke.com	A				

Figure 2.9: Content area example

The content area of an individual DocPak is displayed in a multi-pane. The left pane contains links used to locate DocPak content and update information. When a link is selected from the left pane, the right pane displays the contents of the category selected.

DocPaks

[Print DocPak](#) [Download DocPak](#) [Download Index](#) [Copy DocPak](#) [Expire DocPak](#) [Back to Search Results](#)

Ensuring Quality

[Line Items](#)

[Create Line Item](#)

[Attachments](#)

[Add Attachment](#)

[Recipients](#)

[Updates](#)

[Search DocPak Updates](#)

[Search](#)

Add documents to DocPak from:
Cabinet
Cart

Header
Documents

* Name

Description

Start Date

Expiration Date 05/11/2011

Never Expire

Status Active

Public

Change Notification Approve changes before notifying recipients

Automatically notify recipients after a change has been made

Receive Email Notification for Publisher

Create DocPak Index Attachment

Figure 2.10: Multi-paned content (DocPaks page)

Page Navigation Options

Since a content area may contain large lists that require more than one page (e.g., documents, DocPaks, DocPak recipients), the Go button and links at the bottom of the page allow you to traverse to additional pages.

<< First | < Prev Page 1 of 2 Next > | Last >>

Figure 2.11: Page navigation options

The options available are as follows:

- *Page* and *Go* – Enter the page number in the text field then click the *Go* button to display the selected list for that page.
- *First* – Displays page 1 of the list.
- *Prev* – Displays the previous page of the list.
- *Next* – Displays the next page of the list.
- *Last* – Displays the last page of the list.

The page currently displayed and the total number of pages available are displayed at all times. For example, “Page 3 of 6” indicates you are currently viewing page 3 out of 6.

What’s Next?

This concludes the introduction to DigitalPaper XE. Go to *Getting Started* to begin the *Quick Tour* chapters that provide the procedures for performing the tasks described in this chapter.



Part II

Quick Tour

Chapter 3

Getting Started

This chapter describes the procedures for accessing DigitalPaper XE as well as updating your account information in the following sections:

- *Access DigitalPaper XE.*
- *Update Your Profile.*
- *Download the DP Print Helper Application (Netscape/Firefox Users Only).*

Access DigitalPaper XE

To access DigitalPaper XE, do the following:

Launch a web browser.

1. Enter the URL for the DigitalPaper XE application, for example:

(a) `http://digitalpaper.yourcompany.com` or

(b) `http://servername:port`

Please contact your system administrator if you do not have this URL.

2. The User Login page appears. If you are not required to log in, go to the next step.

User Login
 User Name
 Password
 Remember my User Name

 Forgot your Password? Enter your 'User Name' above and [click here](#).
 POWERED BY
eDigitalPaper[®] DOCUMENT ACCESS AND COLLABORATION. ANYTIME. ANYWHERE.
Copyright © 1997-2019 ePlus Capital, Inc. All Rights Reserved
 Protected by U.S. Patents 6,182,127; 6,510,459; 7,185,069, 7,647,373 and corresponding foreign patents. Patents Pending.

Figure 3.1: User Login page

- (a) Enter your *User Name* and *Password* as designated by the system administrator.
- (b) If you would like your User Name to be remembered by the system the next time you access the login screen, mark the checkbox. If not, disable the checkbox.
- (c) If you cannot remember your password, enter your user name in the field provided, then click the *click here* link beneath the *Login* button. A dialog will appear informing you that you will be sent an e-mail containing further

instructions. Click *OK*. From your e-mail application, open the e-mail sent to you by the system. Enter the password in the User Login page.

- (d) Click *Login*.

Note

You can modify your password and other account information as described in *Update Your Profile*.

3. Digital Paper's home page appears as shown below.

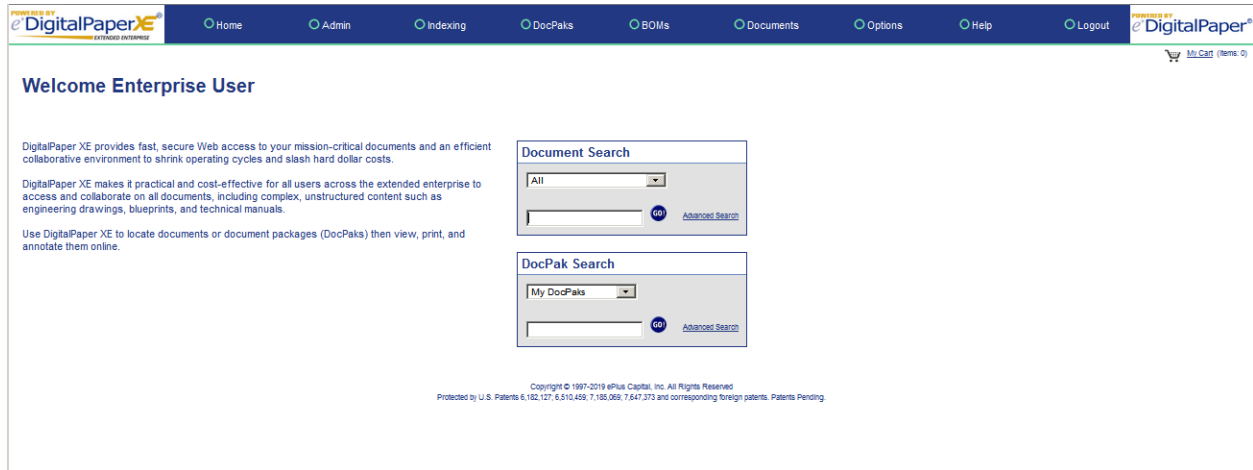

Figure 3.2: DigitalPaper XE home page

You have the following options from this page:

- Search the Document Repository – Search the DigitalPaper XE document repository by cabinet, document number, revision level, or any other document attribute. Once found, documents can be reviewed, marked up, sent to other DigitalPaper XE users, printed, or downloaded. For instructions on conducting this type of search, go to *Working with Documents*.
- Create and View Saved Document Packages – View saved DocPaks by their attributes, view the contents of DocPaks, create new ones, send them to other DigitalPaper XE users, receive DocPaks, or delete them. The contents of DocPaks can be reviewed, marked up, sent to other users, printed or downloaded. For instructions on how to perform these tasks, see *Assembling and Receiving Business Packages*.
- Work with Bills of Materials – If Bill of Materials processing is enabled, you may search, view, print, and download Bills of Materials and the documents contained within them. See *Bill of Materials* for more information.
- Set Options, Get Help, and Logout – You may change your personal options and preferences, view print job status, display the contents of this manual as a PDF file, and logout using the available *Options*, *Help*, and *Logout* functions. See *Options, Help, and Logout Functions* for more information.

Update Your Profile

To change the password information used to log into the system, name or e-mail address, do the following:

Click the Options link in the navigation bar.

- The User Options page appears.

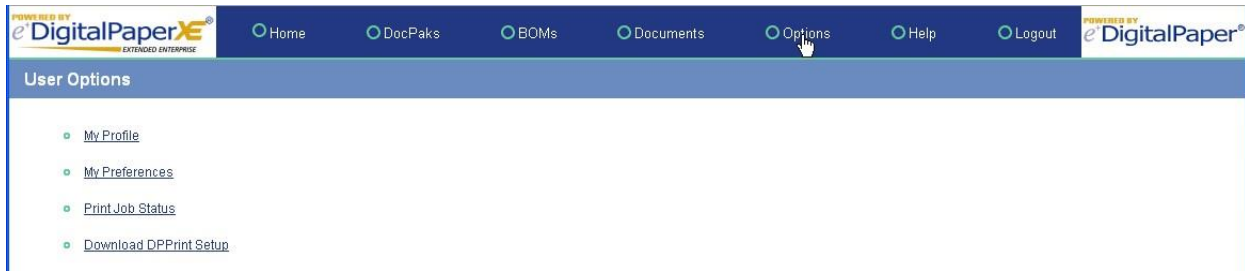

Figure 3.3: User Options page

2. Click the *My Profile* link in the User Options page.
3. The My Profile page appears.

Figure 3.4: My Profile page

4. You can change any of the options displayed in this page except your username:
5. To change your password, enter the new password in the *Password* field, then re-type the password in the *Re-enter Password* field. Please contact the DigitalPaper XE system administrator for the password policy that has been implemented for the system.
6. Change your first or last name as desired.
7. Enter your employer's name as desired.
8. Enter a new e-mail address if needed.
9. Click *Save*.

Update Your Preferences

To personalize default display and printer settings to match your preference for each, do the following:

1. Click the *Options* link in the navigation bar. The User Options page appears.
2. Click the *My Preferences* link in the User Options page. The My Preferences page appears.

My Preferences

Display Mode: Thumbnail

Hits Per Page: 50

Cabinet: All

Printer: 8830

Main Viewer Resolution: 1024 x 768

DocPak Viewer Resolution: 896 x 640

Indexing Viewer Resolution: 896 x 640

DigitalPaper XE Viewer: DPXE Viewer

DPXE Viewer Annotations Enabled: No

BoM Status for Search: All

BoM Search Sort Order: Title Ascending

Save Cancel

Figure 3.5: My Preferences page

3. You can change any of the options displayed in the page as desired. See *Update Your Preferences* for more information.
4. Click *Save*.

Download the DP Print Helper Application

You must download the DP Print Helper application from the User Options page, then run the downloaded executable in order to perform client-side printing, copy documents to the clipboard, or print a selected area from the Viewer as described in *Working with Documents*.

For more information, see *Downloading DP Print*.

Chapter 4

Working with Documents

This chapter provides examples for the following tasks:

- *Search for Documents.*
- *View a Document's Image.*
- *Annotate a Document.*
- *View Document Properties.*
- *Printing a Document.*
- *Download a Document.*

Search for Documents

Documents stored in the DigitalPaper XE repository are indexed so you can perform searches based on each document's attributes. If you do not know the document's attributes, you can search one or all cabinets within the repository, search by a partial list of known attributes, or search using wildcards.

To search for one or more documents in the DigitalPaper XE repository, do the following:

1. Click Documents from the Navigation bar at the top of the window.

The Search for Documents page appears. Note that the figure below shows the minimum number of search criteria (i.e., Document Revision and Release Date) that will appear on this form. Other search criteria—such as Document Name, Document Number, Model, etc.—may appear in this form depending on how the DigitalPaper XE system was configured by the administrator.

Search For Documents Select Cabinet: All

Fill in one or more of the following fields. Hint: 123' finds all documents starting with 123

Document Number

Document Revision

Cross DocPak search Yes No

Type of search Match Any Field Match All Fields

Display results as Condensed Thumbnail Sorted

Number of results per page

Include archived documents

Automatically view if only one result is found

Search

Figure 4.1: Search for Documents

2. Conduct your search by completing the Search for Documents form with as much information as possible.
3. See *Search Examples* for examples on how to conduct a search.

Search Examples

Below are sample methods for performing both general searches as well as refined searches.

Method 1: Search for all Documents

1. Select All (to search the entire repository) or select a specific cabinet (e.g., Engineering, Manufacturing, Transportation, Utilities) from the Select Cabinet pull-down menu.
2. Skip the section labeled: *Fill in one or more of the following fields.*
3. Disregard the *Type of search* options since no fields were completed.
4. If desired, set any of the following optional display settings (please note the settings which are recommended below). Otherwise, go to the next step.
5. Enter the number of results you want the system to display on the Search Results page.
6. (Recommended) Since you are searching for all documents within a repository or cabinet, for performance reasons, set *Display results list* to Condensed. The results will be displayed without a preview image of the document, thus search results for a large number of documents will be returned faster.
7. (Recommended) Since this type of search may return a large number of documents, deselect the *Include archived documents* checkbox to view only the most current documents.
8. Ignore the *Automatically view if only one result is found* since in most cases there will be more than one document returned for this type of search.

Click Search. The Search Results page will appear with the collection of documents for the entire repository or the selected cabinet.

Document Search Results [51 found]				New Search	View Cart (0)
<input type="checkbox"/> Select All	<input type="checkbox"/> Print	<input type="checkbox"/> Download	<input type="checkbox"/> Add to Cart	<input type="checkbox"/> Delete	Display Condensed
Document Attributes	Revision	Action			
<input type="checkbox"/> Doc No: 25670 Sheet: 1 Doc Name: Nike Smoke Assy.	A				
<input type="checkbox"/> Doc No: 25808 Sheet: 1 Doc Name: Nose Cone	B				
<input type="checkbox"/> Doc No: 318661 Sheet: 1 Doc Name: Fuselage Camera Assy.	A				
<input type="checkbox"/> Doc No: 7037401101 Sheet: 1 Doc Name: Spring Assy.	A				
<input type="checkbox"/> Doc No: 97531 Sheet: 1 Doc Name: Rotator Slip Ring	D				
<input type="checkbox"/> Doc No: 2009-11-25-1 Sheet: 1 Doc Name: Nike Smoke Assy.	C				
<input type="checkbox"/> Doc No: 2009-11-30-1 Sheet: 1 Doc Name: Sentry Rocket Assy.	A				
<input type="checkbox"/> Doc No: 2009-12-21-1 Sheet: 1 Doc Name: Nose Cone	A				
<input type="checkbox"/> Doc No: 2010-01-08-1 Sheet: 1 Doc Name: Fuselage Camera Assy.	A				
<input type="checkbox"/> Doc No: 2010-01-12-1 Sheet: 1 Doc Name: Spring Assy.	A				

Figure 4.2: Search Results (condensed view)

Note

Depending on how the system was configured, some attributes associated with a document may not be displayed in the *Document Search Results* page. To view additional attributes (if any), See *View Document Properties*.

- To refine your search, click the New Search link in the Document Search Results page bar, then follow the instructions in *Method 2: Perform a Refined Search*. If satisfied with the search results, go to *Options from the Search Results Page*.

Method 2: Perform a Refined Search

From the Search for Documents page, select the desired cabinet (e.g., Engineering, Manufacturing, Transportation, Utilities) from the Select Search Cabinet pull-down menu.

- In the *Fill in one or more of the following fields* section, enter as much information as possible about the document's attributes in the fields provided.

Figure 4.3: Search page with search criteria entered

Tip

Utilize the following search operators to perform searches on attributes based on a partial entries, perform OR searches, search for a range of values, or search for values that are greater than, less than, or equal to the entered value.

Search Option	Description	Example
Full text	Search is conducted on the exact description entered.	Document Name: Interface Cabling Diagram Returns all documents with the document name: "Interface Cabling Diagram".
*	Search to match zero, one, or more characters.	Document Name: *ing Returns documents with the following in the title: "Stamping", "Printing", "Cabling" or "Manufacturing"
?	Search to match any one character.	Document Name: ?ing Returns documents with the following in the title: "Ring" or "King"

Search Option	Description	Example
	Separate items in an OR search.	Document No: 111 222 333* Returns documents numbered 111 or 222 or 333, 3331, 3332, 33345, etc.
>	Search for values that are greater than the number entered.	Document No: > 111 Returns all documents numbered 112 or greater (e.g., 112, 113, 114) alpha characters cannot use this operator.
<	Search for values that are less than the number entered.	Document No: < 111 Returns all documents numbered 110 or less (e.g., 107, 108, 109 110) alpha characters cannot use this operator.
=>	Search for values that are greater than or equal to the number entered.	Document No: => 1 Returns all documents with a numeric label of 1 or greater (e.g., 1, 2, 3, 4) alpha characters cannot use this operator.
<=	Search for values that are less than or equal to the number entered	Document No: <= 3 Returns all documents with a numeric label of 3 or less (e.g., 1, 2, 3) alpha characters cannot use this operator.
-	Search for a range of values.	Document No: 100 - 500 Returns documents 100 through 500. If searching for a field that utilizes a numbering schema based on the varchar database type, and that numbering schema utilizes dashes (e.g., document number C5N-2-4566), you will not be able to search for ranges within that field.

Select one of the following:

1. Match All Fields to return documents that exactly match the criteria entered in all attribute fields, or
 - (a) Match Any Field to return all documents that match any of the criteria entered in the attribute fields.

If desired, set any of the following optional display settings. Otherwise, go to the next step.

- (a) Enter the number of results displayed in the Search Results page.
- (b) Select the display results as either Thumbnail to display a preview of the image with the search results, Condensed to display the results without the preview image, or Sorted to display the results sorted by document number. If you believe a large number of documents may be returned, the latter selection is recommended.

- (c) Select the *Include archived documents* checkbox if you are interested in viewing all document versions; if you are only interested in the most current version of a document, it is recommended you deselect this checkbox.
- (d) If you are searching for a single document and you wish to bypass the Search Results page to view its contents with DigitalPaper XE's viewing tool, select *Automatically view if only one result is found*. For more information on how to use the viewing tool, See *View a Document's Image*.

2. Click Search. The Search Results page will appear.

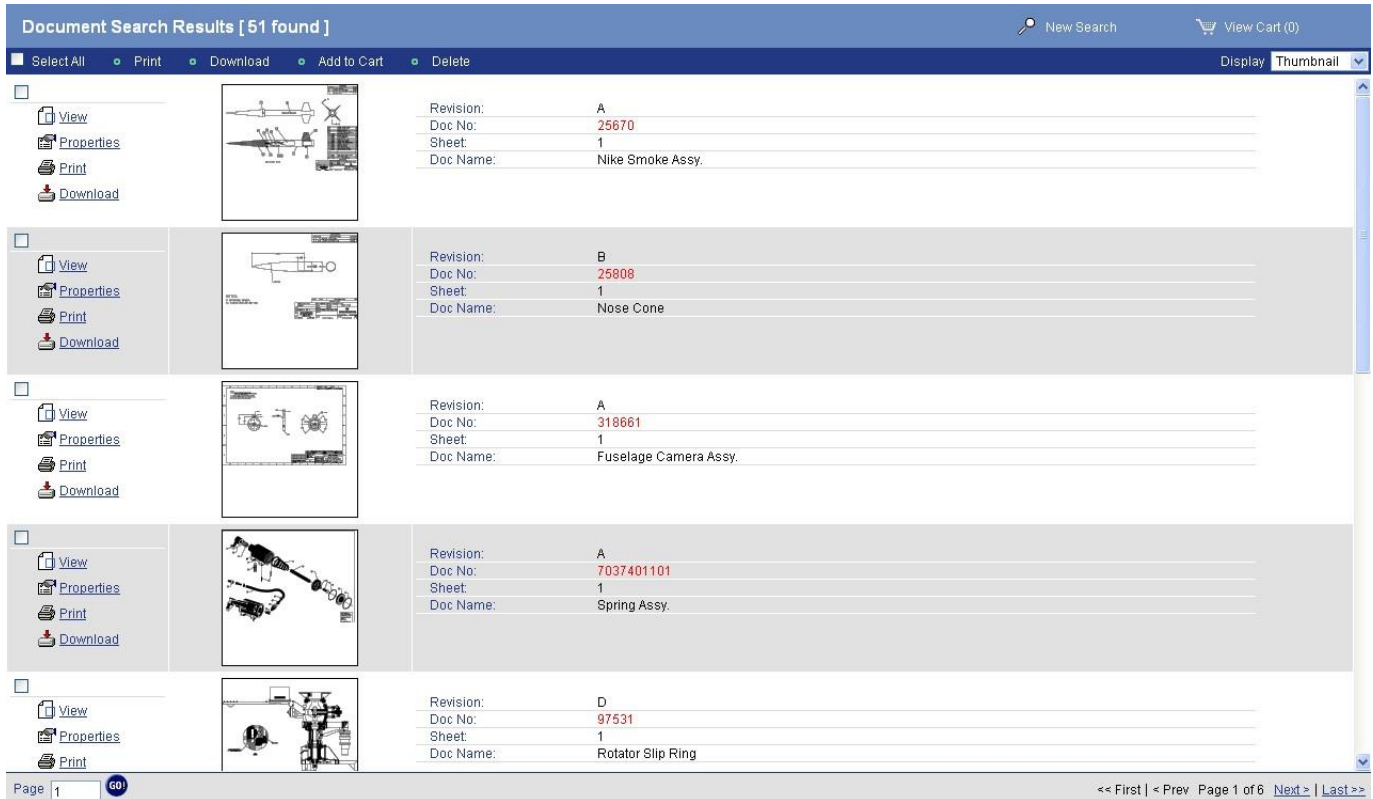

Figure 4.4: Search Results (Thumbnail view)

Note

If the document was imported as a non-native format, the icon associated with the file's MIME type will appear in the area reserved for the thumbnail image (e.g., Adobe Acrobat icon will appear if the file is a PDF).

3. To further refine your search, click the New Search link in the Document Search Results page bar, then repeat the steps listed in this section.
4. Go to *Options from the Search Results Page*.

Options from the Search Results Page

When satisfied with the search results, you have the following options from the Search Results page:

- View a document's image. For more information, See *View a Document's Image*.
- Mark up a document with text and graphics. For more information, See *Annotate a Document*.
- View a document's properties (attributes, revision history, saved annotations). For more information, See *View Document Properties*.
- Print a document. For more information, See *Printing a Document*.

- Download a document. For more information, See *Download a Document*.

View a Document's Image

To view the image associated with a document, do the following:

1. Left-click the View link, icon , or the thumbnail image associated with the document (if displayed). Depending on the document's file type, one of the following will occur:
2. If the file was imported as a native file that is not supported by the Viewer (e.g., Microsoft Excel, Microsoft Word), you will be prompted to download the file to your computer. For more information on file download, See *Download a Document*.
3. If the file type is supported by the Viewer, and consists of one page only, the document will appear in the Viewer as shown below. (NOTE: If you are using the modern viewer - DPXE Viewer – jump ahead to the section titled *DPXE Viewer*.) If the View Annotations When Document Initially Viewed global parameter is in use for your organization, the system displays all the annotations associated with a document when a document is initially displayed in the viewer..

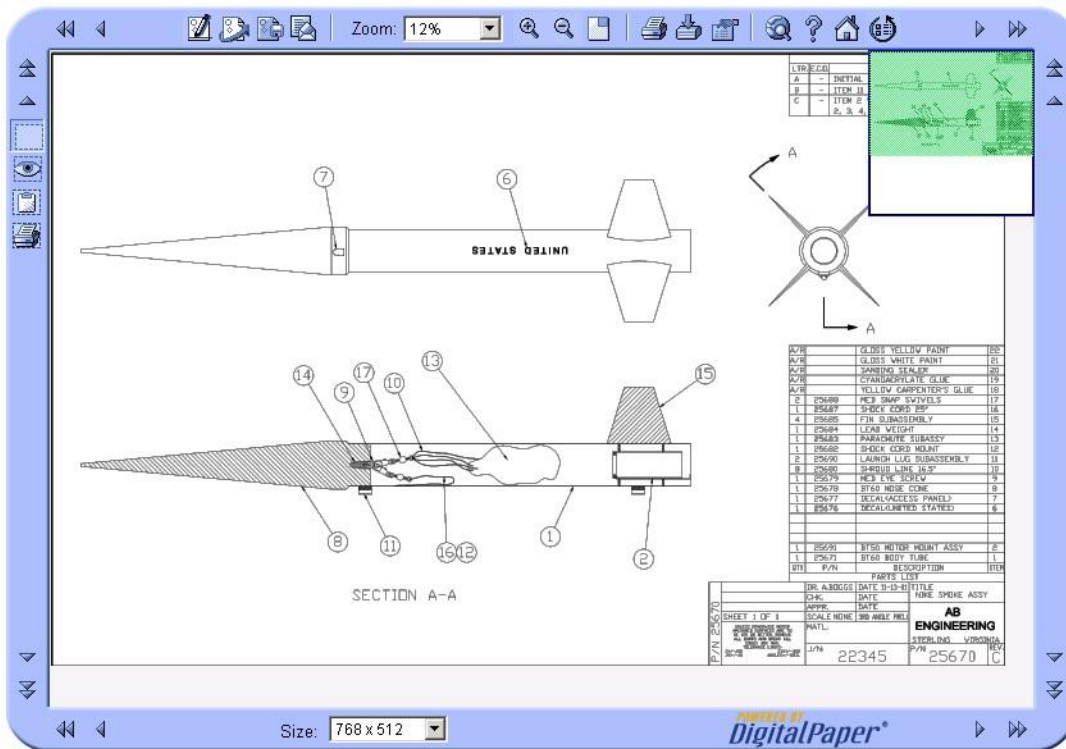





Figure 4.5: Viewer (single page document)

Note

If needed, use the Zoom menu or zoom buttons    to achieve the desired magnification of the image.

4. If the file imported is supported by the Viewer, and consists of multiple pages, a "table of contents" will appear in the left pane; the Viewer displaying the first page of the document will appear in the right pane.

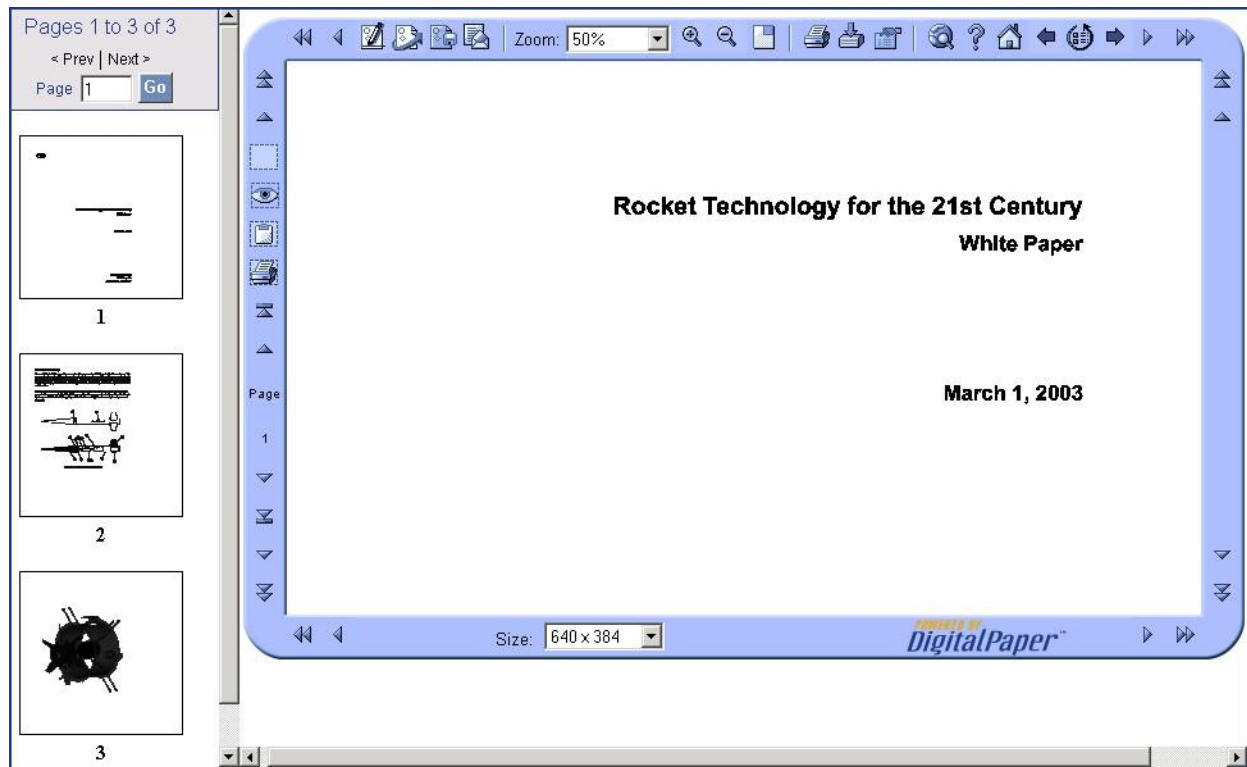

Figure 4.6: Multi-page document in the Viewer

5. To display different pages of a multi-page document, scroll through the table of contents (or Page List) in the left frame then click a thumbnail to display that page. You can also enter a page number in the text box and click the GO! button to display the selected page. Note that the Prev and Next links in the Page list are for navigating through the set of thumbnails displayed, not each page of the document. The arrows that surround the displayed page number on the left edge of the blue Viewer frame may be used to navigate through the individual pages.
6. To resize the frame size of the Viewer, select a new option from the Size menu at the bottom center of the Viewer frame.



Navigate an Image in the Viewer

There are multiple options for navigating the image. This section describes the methods for panning the image as well as using the Bird's Eye View feature to view the areas of interest. With the document displayed in the Viewer, perform each of the following functions.

Panning

To move through the displayed document while maintaining the selected zoom level, select from one of the two methods listed below.

Panning: Method 1

1. Click the Define Area button  if it is not already in its default selected state .
2. Move your cursor over the image; Click to define one corner of a box, then click any area within the document image (except the Bird's Eye View thumbnail which is located inside or outside of the Viewer frame, if displayed) to select an area of the image.

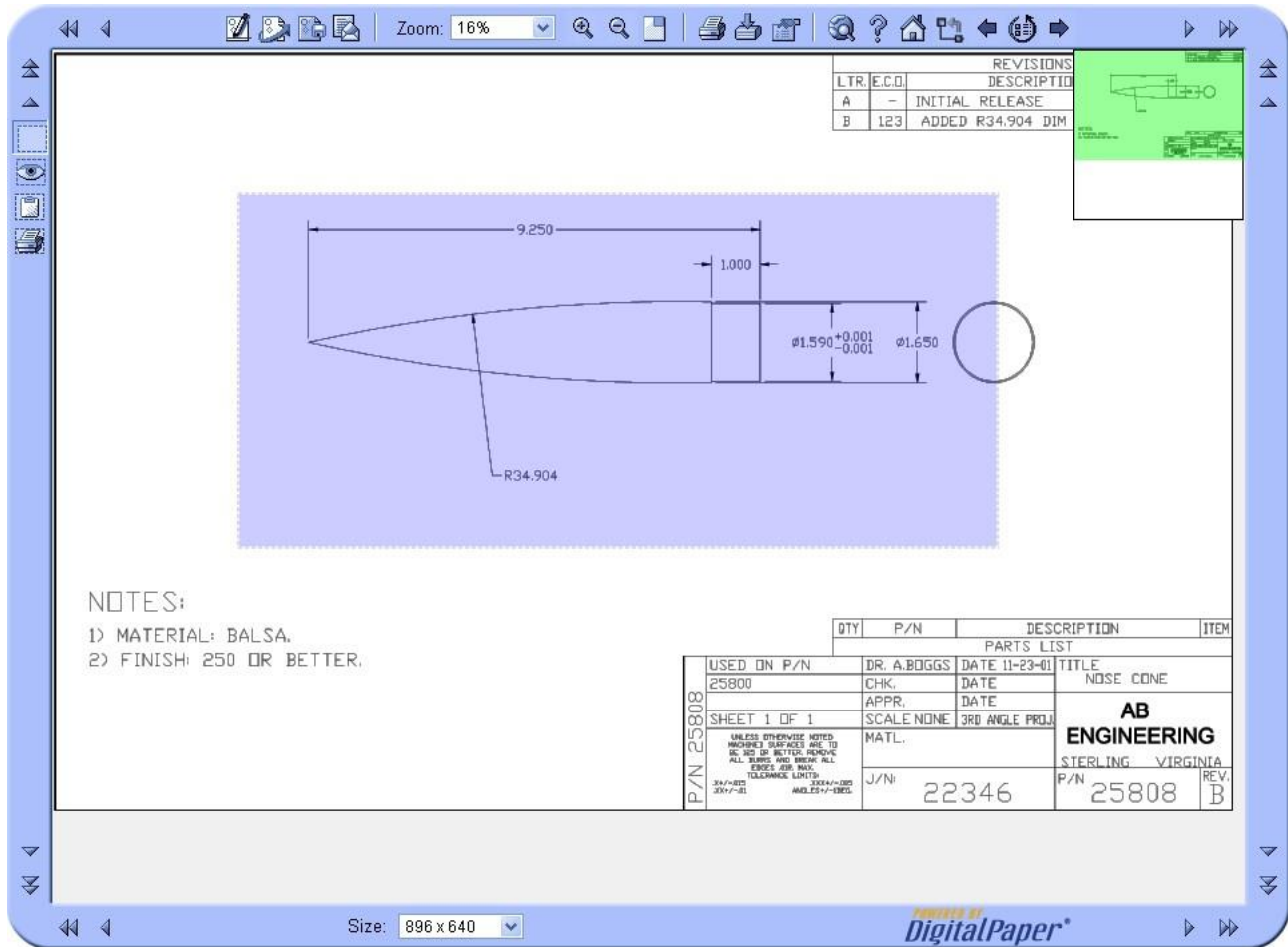



Figure 4.7: Select a portion of the Image

3. Click the View Area button. 
4. The Viewer will zoom to the area you selected.

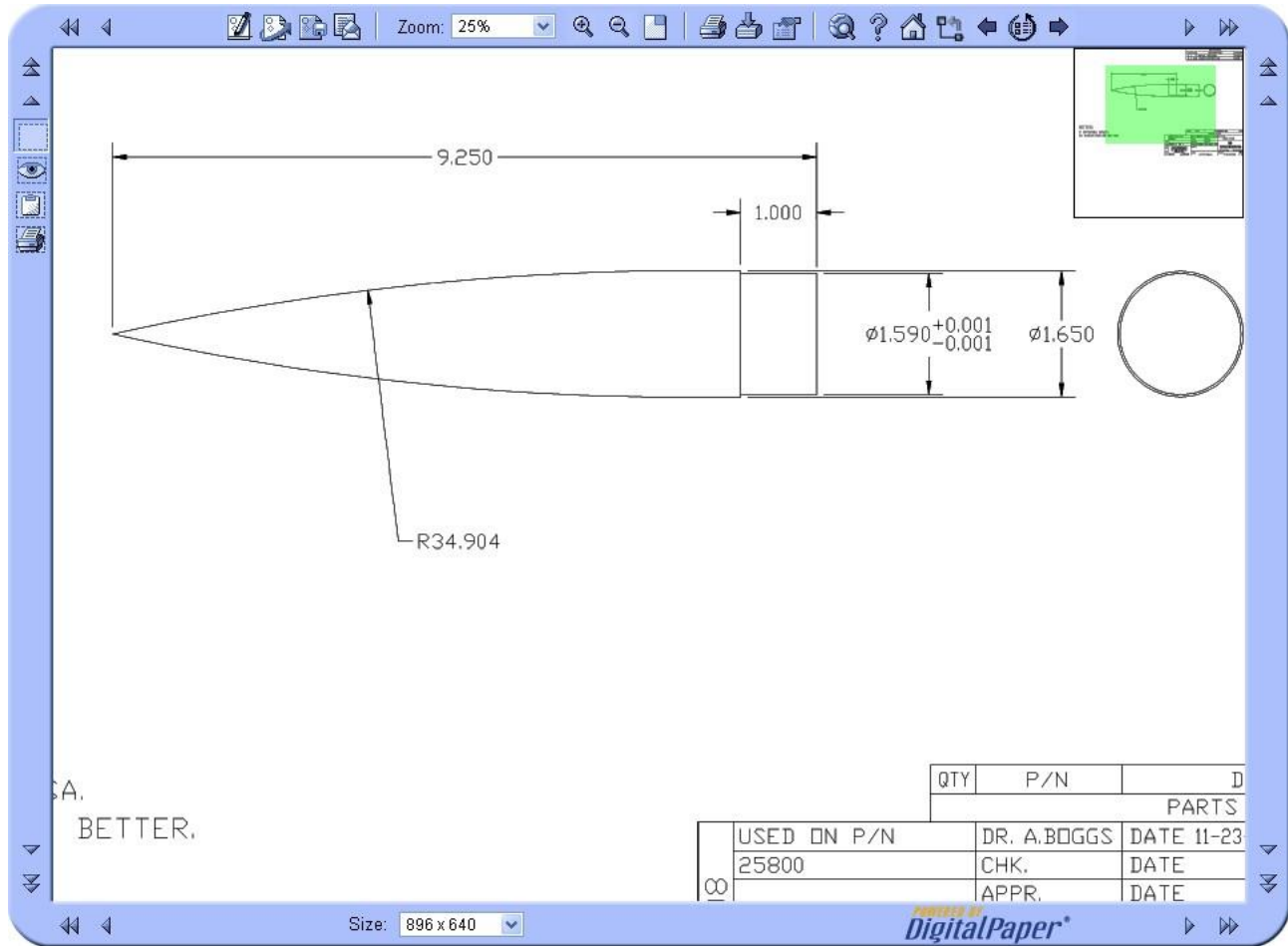



Figure 4.8: Zoom to Selected

5. Go to *Bird's Eye View* to move the selected area to a different part of the image..

Panning: Method 2

1. Click any of the single arrow buttons  located on the corners of the Viewer to move the document 128 pixels (.853 inches) in the arrow's direction (i.e., up, down, left, right).
2. Click any of the double arrow buttons  located on the corners of the Viewer to move the image the distance equivalent to the size of the Viewer window (i.e., one frame) in the direction of the selected double arrow (i.e., up, down, left, right).
3. Go to *Bird's Eye View* to utilize a different technique for navigating through an image.

Bird's Eye View

The Bird's Eye View lets you quickly navigate to different parts of the drawing by selecting an area of interest from a dynamic thumbnail image.

1. If not enabled, click the Bird's Eye View button  to place a dynamic thumbnail image of the document within or around the Viewer frame.

Note

Although the Bird's Eye View is displayed in the top-right area of the Viewer in this guide, the system administrator may configure the Bird's Eye View to appear in one of several different locations that falls just inside or outside of the blue Viewer frame.

The green-shaded rectangle within the Bird's Eye View thumbnail denotes the area of the document currently displayed and is therefore not selectable.

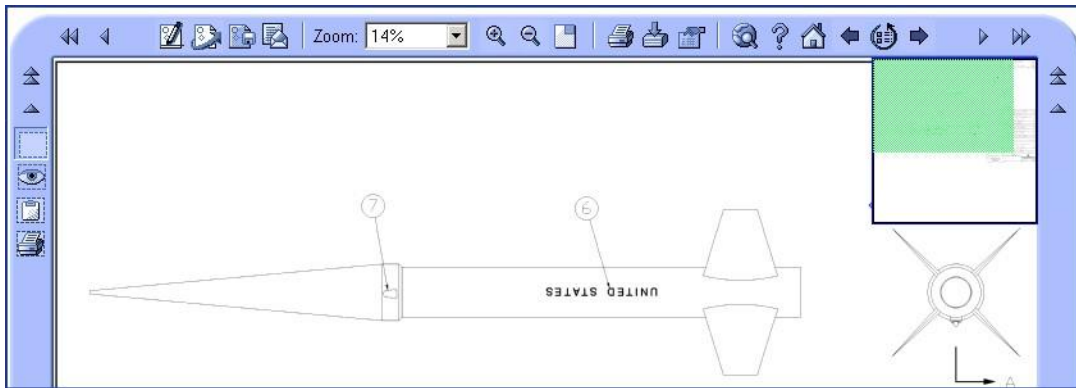

Figure 4.9: Bird's Eye View

2. With the cursor inside the Birds Eye View thumbnail but outside the shaded green rectangle, click the area of the document to be displayed. In this example, the area of the drawing that contains the document's attributes (i.e., the lower right-hand corner) is selected for display.

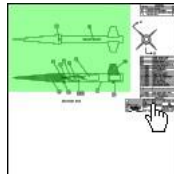

Figure 4.10: Click an area inside the Bird's Eye View

The image redraws with the selected area displayed in the center of the Viewer. Notice in the Birds Eye View that the green rectangle covers the area currently displayed in the Viewer.

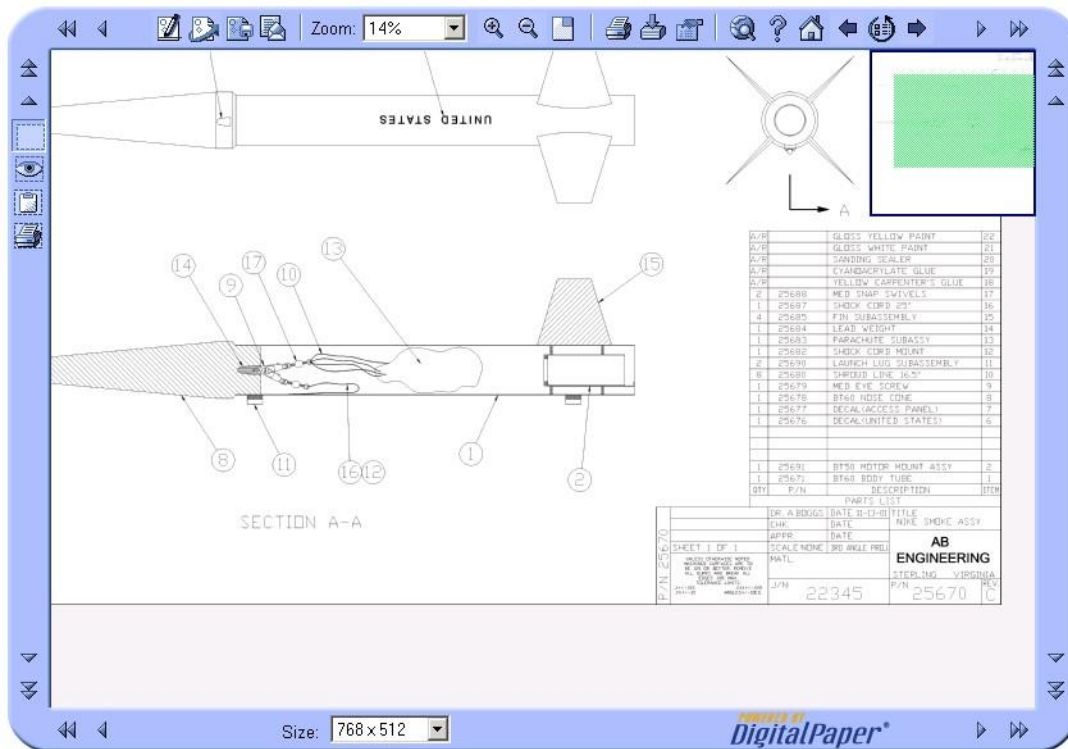

Figure 4.11: Image redrawn

Note

You may hide the Bird's Eye View at any time by clicking an enabled Bird's Eye View button.

Zoom to a Selected Area

To magnify an area of an image:





1. Click the *Define Area*  button.
2. Move your cursor over the image. When you move your cursor over the image, the cursor turns into a green cross-hair. Click the mouse where you wish the selection area to begin, hold the left mouse key down and draw a selection box to encompass the entire area of interest.
3. Click the *View Area*  button. The image will be redrawn with the selected (and magnified) area displayed within the Viewer.



Figure 4.12: Zoom in on selected area using View Area tool

Copy a Portion of a Document to a File Outside of DigitalPaper XE

If you require a portion of a document's image to appear in another application that supports graphics (e.g., Microsoft Word or PowerPoint), follow the steps below.

1. Click the *Define Area*  button.
2. Move your cursor over the image. When you move your cursor over the image, it turns into a green crosshair. Click the mouse where you wish the selection area to begin, hold the left mouse key down and draw a selection box to encompass the entire area of interest.
3. Click the *Copy Area to Clipboard* button. 
4. A pop-up dialog appears with the message *Close DPPrint*. Close this dialog after the *DPPrint Copied to the Clipboard* message box appears.

Note

If a first time user, the DPPrint Application must be installed before you can copy. This process is different according to your browser type as described in the *About DPPrint* section of the *Enterprise User's Guide*.

5. When the copy process has been completed, the following dialog appears.



Figure 4.13: Copied to the Clipboard

6. Click OK in the DPPrint dialog.
7. Open a graphics program and use its paste command to create a new image of the selected area, or open the target document in a text editor that supports graphics, then use that application's paste command to place the selection as a TIFF image in the document.

Note

The size of the selected area being pasted is based upon the document's original size, not its level of magnification in the Viewer.

Print a Selected Area

1. Click the *Print Area*  button to print the selected area to your local printer.

Note

If you are a first time user, you will have to install the DPPrint Application before you can perform the steps that follow in this section. This process is different according to your browser type. For more information, see the *About DPPrint* section of the *Enterprise User's Guide*.

2. Move your cursor over the image. When you move your cursor over the image, the cursor turns into a green cross-hair. Click the mouse where you wish the selection area to begin, hold the left mouse key down and draw a selection box to encompass the entire area of interest.
3. The following DPPrint dialog appears.

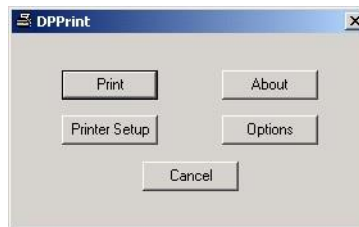

Figure 4.14: DPPrint dialog

4. Click Printer Setup to launch the print setup page associated with your local printer, then click the Print button from that page, or simply click Print from the DPPrint dialog to submit the print job.
5. The following print dialog appears..



Figure 4.15: DPPrint feedback dialog

6. Click OK.

Print the Entire Document

To print the entire document:

Click the *Print* button  located on the top of the Viewer frame.

For more information on printing the entire document, See *Printing a Document*.

Download a Document



To download a document displayed in the Viewer as a TIFF file, do the following:

Click the *Download* button  located on the top of the Viewer frame.

For more information, See *Download a Document*.

View Additional Documents

To view images of other documents listed in the Search Results page (or a DocPaks page) without having to close the Viewer and return to that page, do the following:

1. Click the *Right Arrow* button  from the top of the Viewer frame to view the image associated with the next document listed in the Search Results page (or a DocPaks page).
2. Click the *Left Arrow* button  from the top of the Viewer frame to view the image associated with the previous document listed in the Search Results page (or a DocPaks page).

What's Next?

If you have completed using the Viewer, click the *Close Viewer* button  to return to the *page* where you selected the image to display.

DPXE Viewer

The DPXE viewer is a contemporary implementation of the functions and features available in the classic Digital Paper document viewer.

Main Window

The main window of the viewer consists of a single view pane with groups of view and action controls:

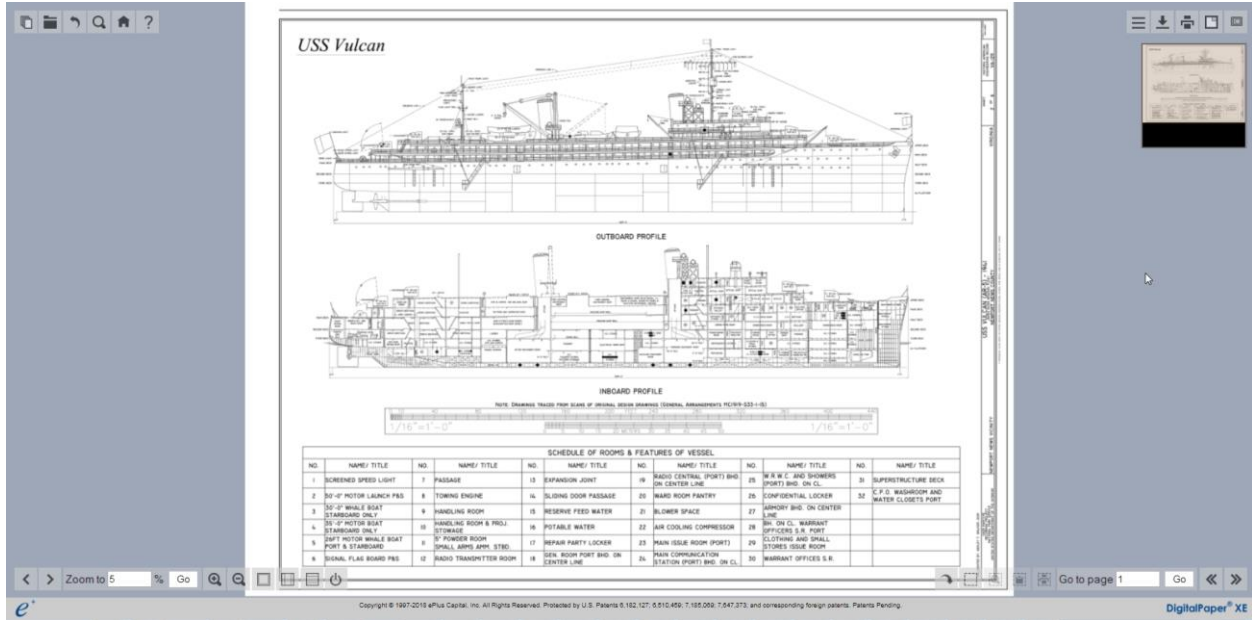













Control Groups



The controls are grouped as follows:





Menu Function Navigation	
	Go to a page within the document
	Go to a document in the search result set
	Go back to the search results page
	Begin a new search
	Go to the XE home page
	Go to the XE Viewer help page

Document Function Navigation	
	Show the document's properties
	Download the document

Document Function Navigation	
	Print the document
	Toggle the Bird's Eye View
	View the document in the classic viewer

Page View Controls	
	View the previous page in the document
	View the next page in the document
	Zoom in
	Zoom out
	Fit to page
	Fit height
	Fit width
	Reset view
The  control shows the current zoom level and can be used to select a specific zoom level.	

Document View Controls	
	View the prior document in the search results set
	View the next document in the search results set

Document View Controls	
	Rotate the view 90 degrees
	Select a region of the image
	Zoom to the selected region
	Copy the selected region to the clipboard
	Print the selected region
The <input type="text" value="Go to page 1"/> <input type="button" value="Go"/> control shows the number of the page in the document currently displayed and provides a way to go directly to a page.	

Bird's Eye View

The bird's eye view shows a thumbnail image of the page currently being displayed.

The highlighted area indicates the specific area currently being displayed in the viewport, as shown here:

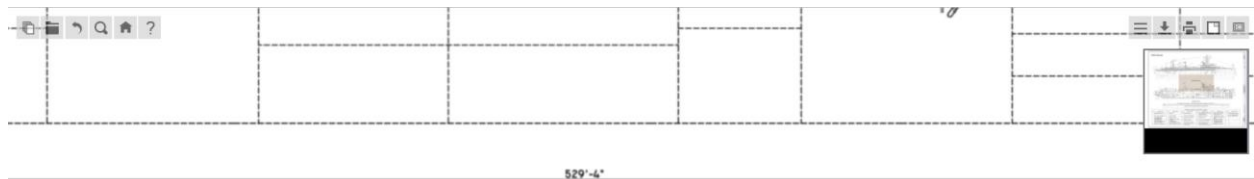

OUTBOARD PROFILE

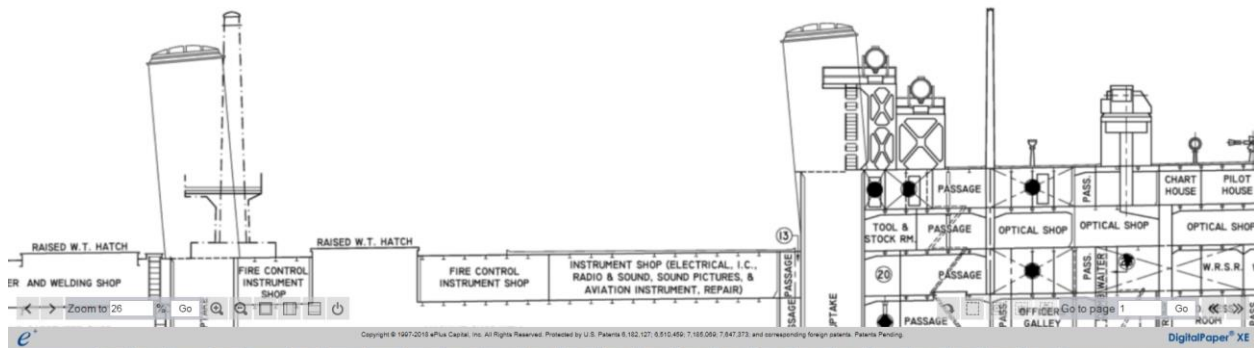

A left mouse click anywhere in the thumbnail will result in re-centering the image in the viewport at that point using the current zoom value, as shown in the following example:

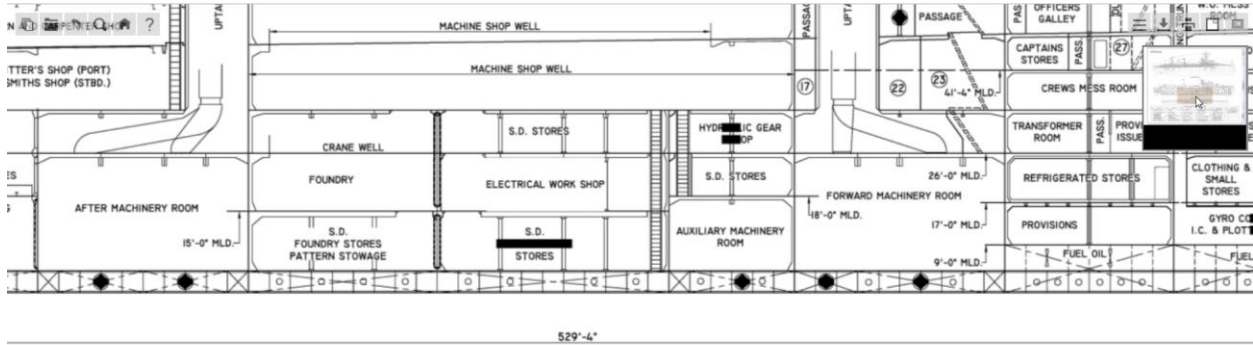
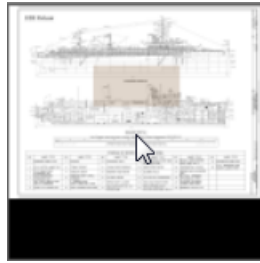

INBOARD PROFILE

NOTE: DRAWINGS TRACED FROM SCANS OF ORIGINAL DESIGN DRAWINGS (GENERAL ARRANGEMENTS MCI919-S33-I-

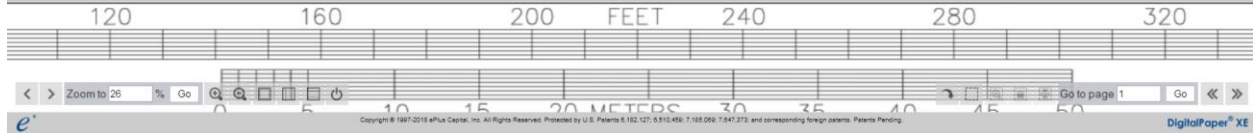

Old Revisions (Not Current Documents)

When viewing an old – not current - revision of a document, NOT CURRENT indicators will be displayed:

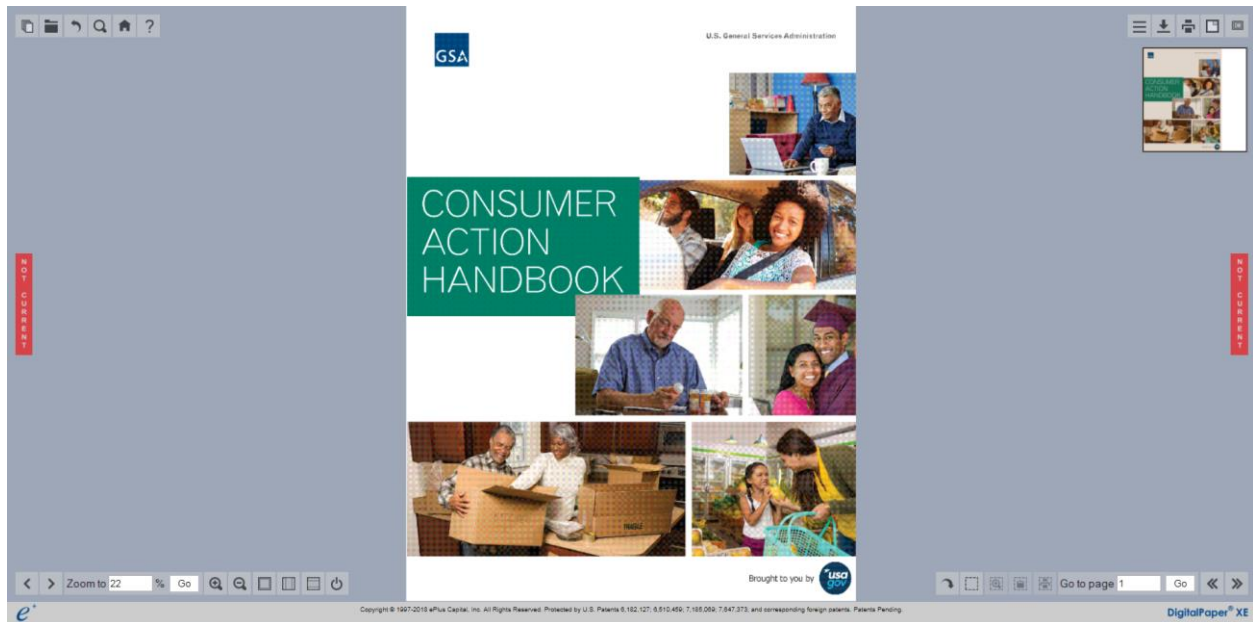

To view the current version of the document, move the mouse pointer over either NOT CURRENT indicator – note that the indicator will change color to GREEN, the current version will be displayed.

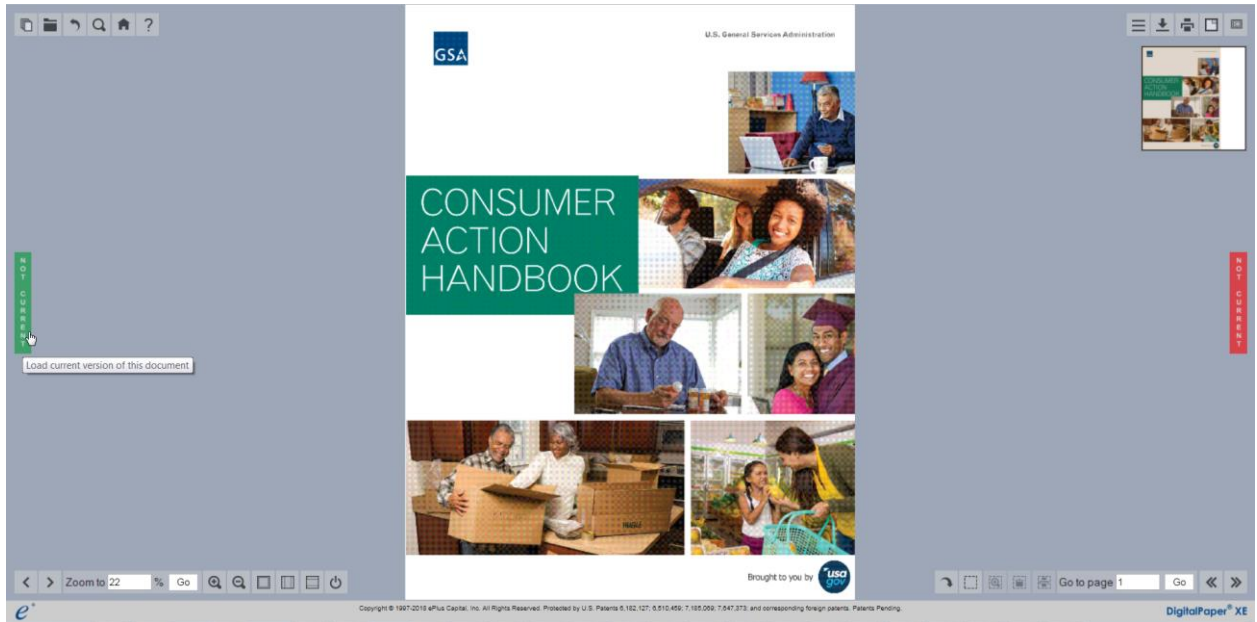

and click. The confirmation box will appear.

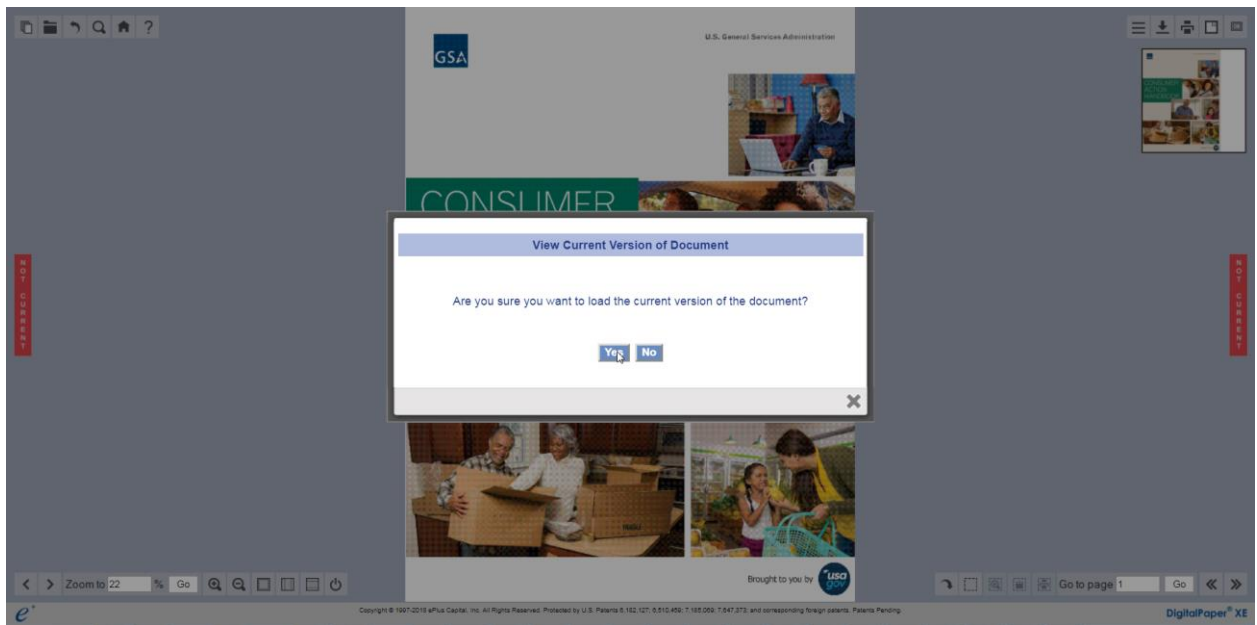

Click Yes. The current version of the document – indicated by the absence of the NOT CURRENT indicators - will be displayed:



Mouse-Based Navigation

Zoom In

To zoom in to a region of the image, move the mouse pointer to the center of the area of interest then rotate the mouse scroll wheel forward.

Example:

Place the mouse pointer between the words *OUTBOARD* and *PROFILE*:

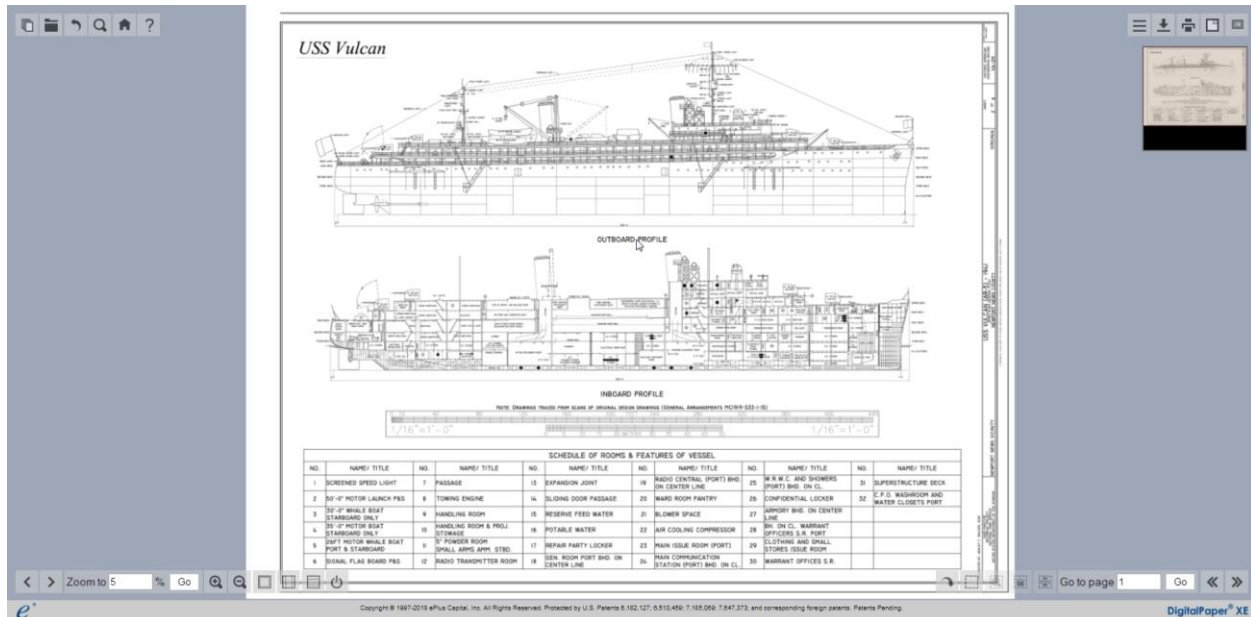

Rotate the mouse wheel forward to zoom in:

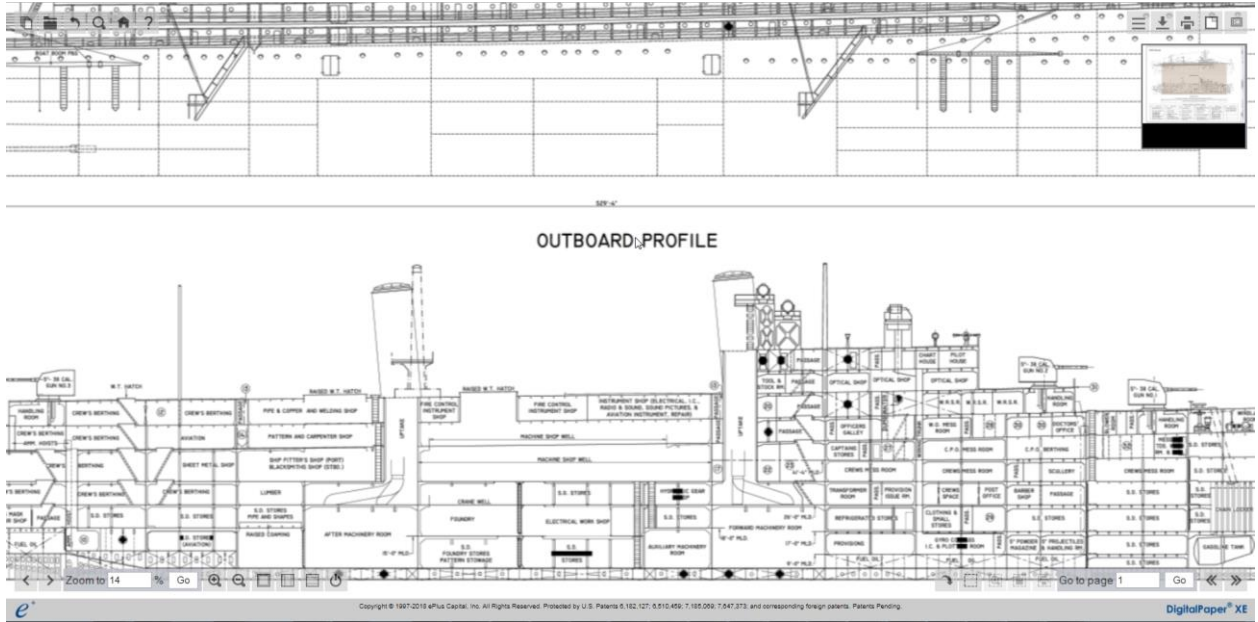

Zoom Out

To zoom out to a region of the image, move the mouse pointer to the center of the area of interest then rotate the mouse scroll wheel backward.

Example:

Place the mouse pointer between the words *OUTBOARD* and *PROFILE*:

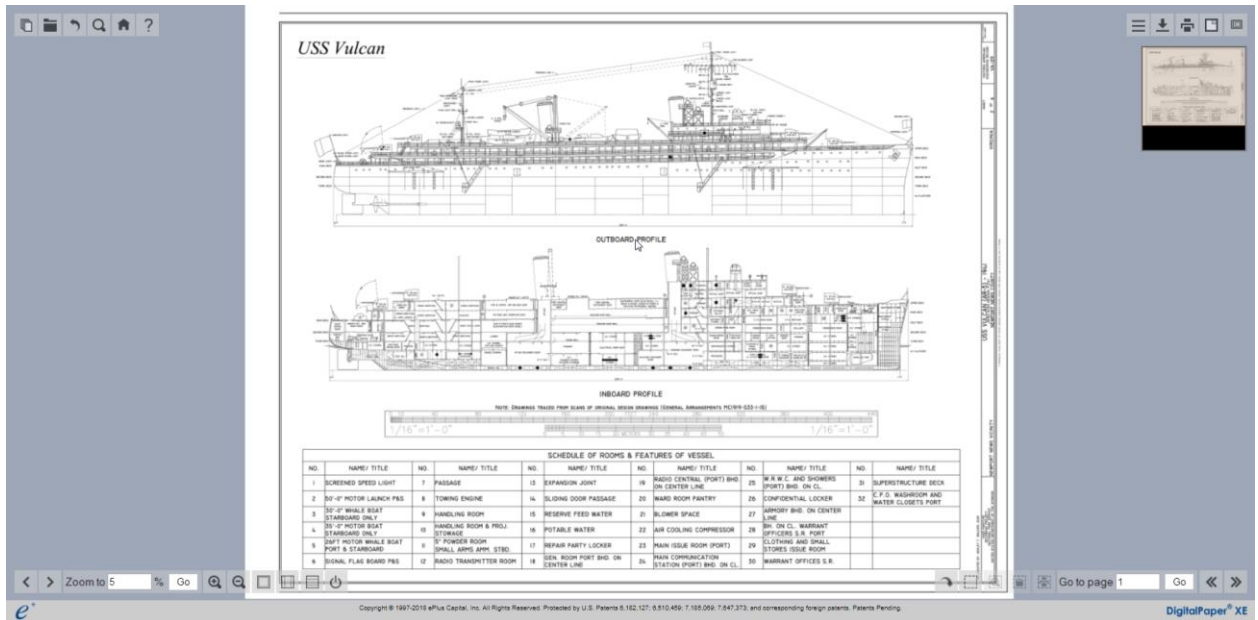

Rotate the mouse wheel backward to zoom out:

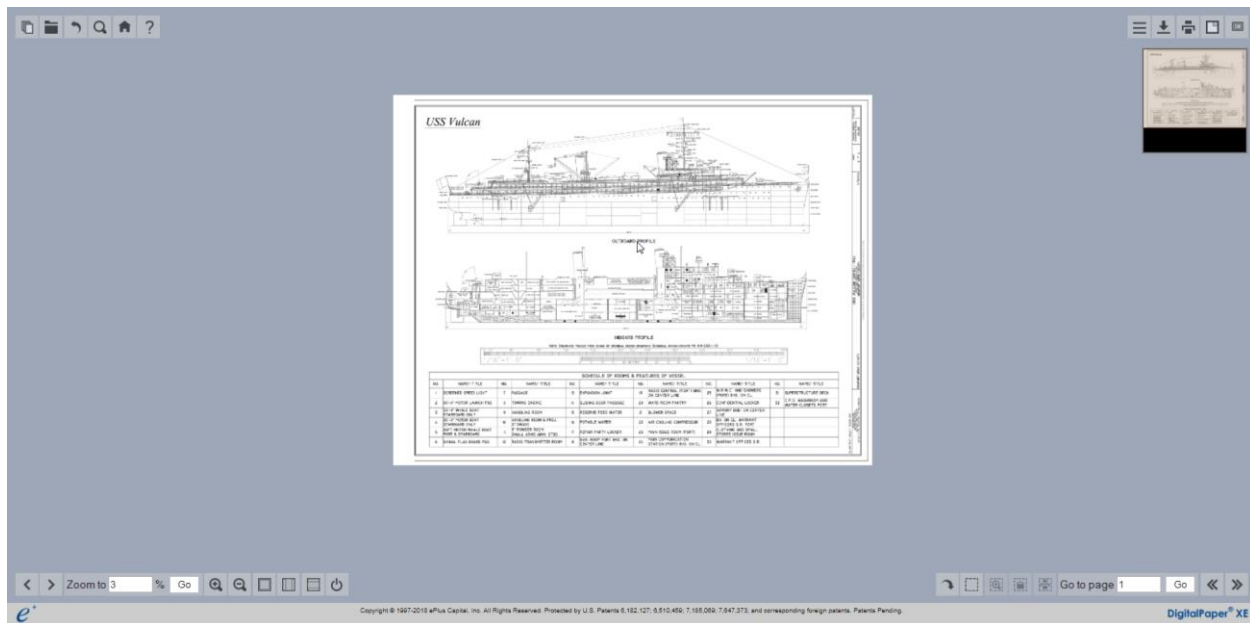

Pan

To pan to a new region of the image,

1. Move the mouse pointer to a location anywhere within the image
2. Click and hold the left mouse button
3. Drag the mouse

Example:

Zoom in as previously described then place the mouse pointer between the words *OUTBOARD* and *PROFILE*:

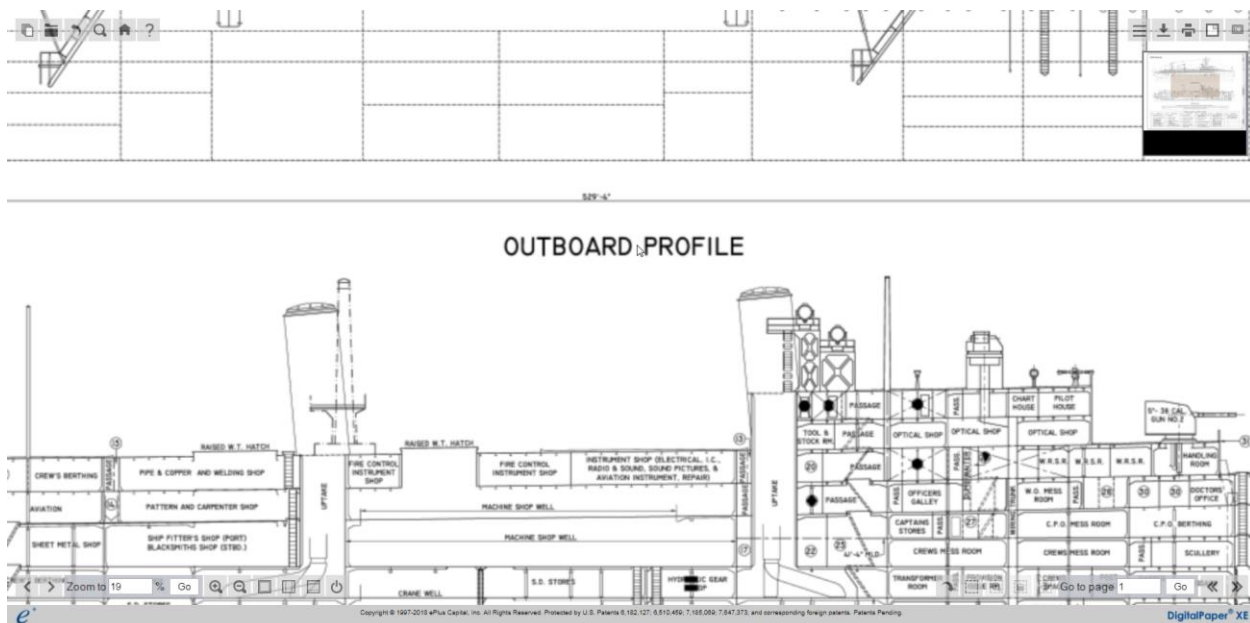

Click and hold the left mouse button then drag the mouse to the right and up:

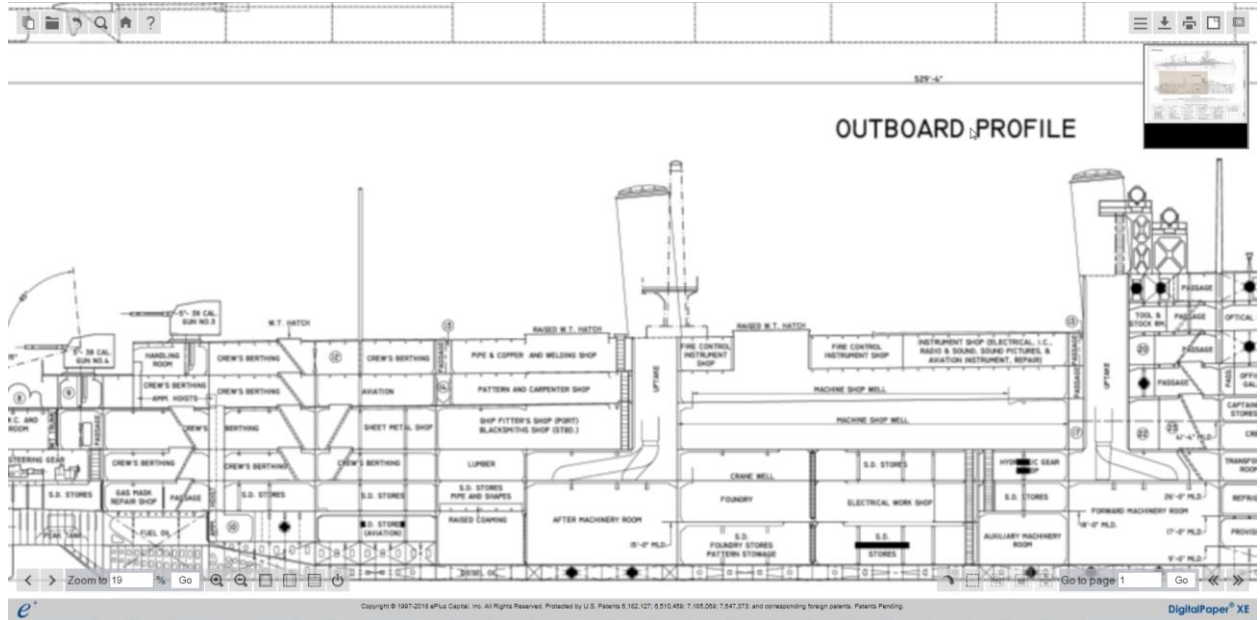

Menu Function Navigation

The menu function navigation controls are used as follows:

Go to a page within the document 

Move the mouse pointer over the control. The list of pages in the document will be displayed as a drop-down list of page numbers and page thumbnails:



Scroll to the page of interest and move the mouse pointer over the thumbnail of the page to display:



Click on the thumbnail. The page will be displayed.



Go to a document in the search result set 

Move the mouse pointer over the control. The list of documents in the search results set will be displayed as a drop-down list of attributes and document thumbnails:

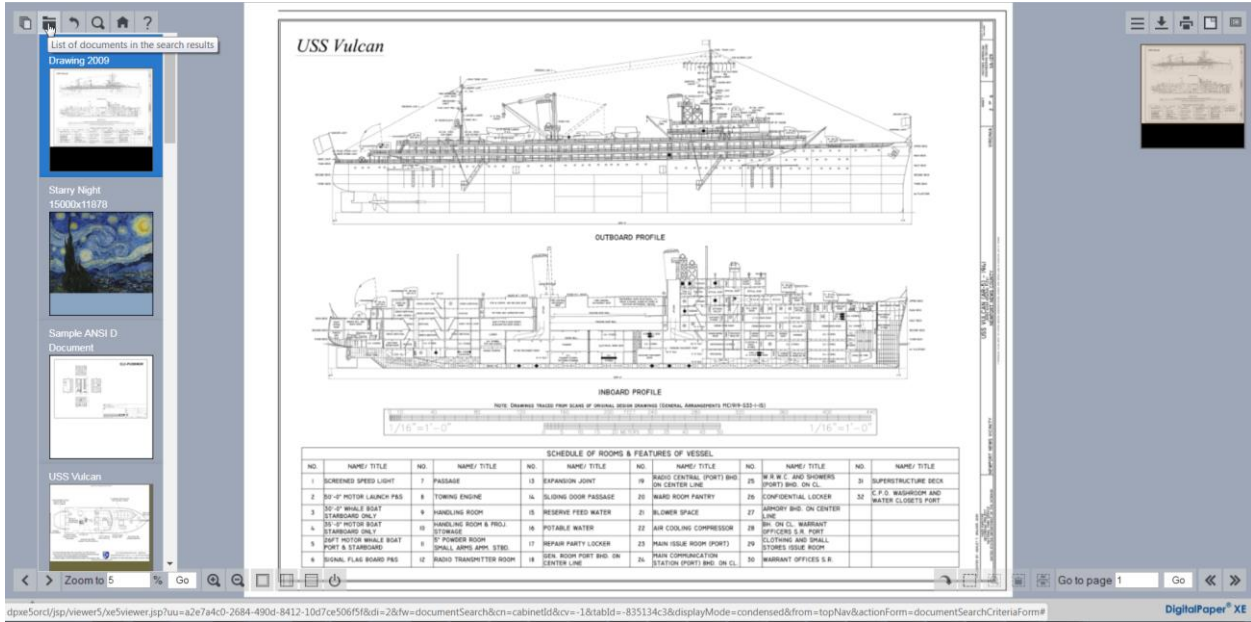

Scroll to the document of interest and move the mouse pointer over the thumbnail of the document to display:

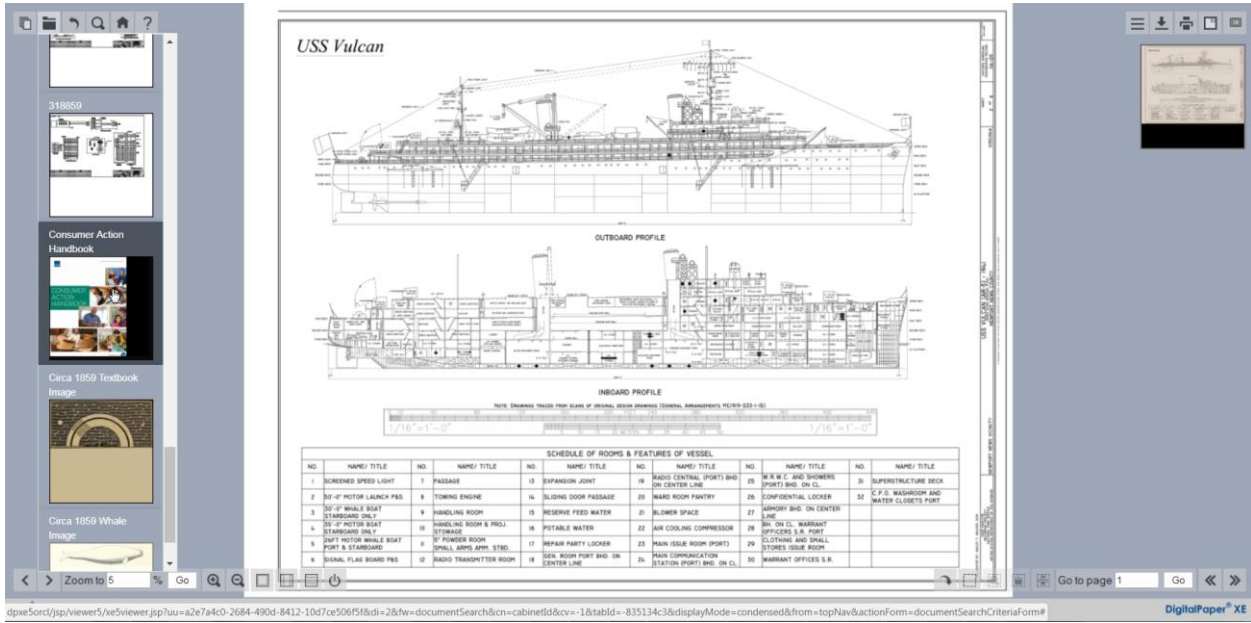

Click on the thumbnail. The first page of the document will be displayed.



Go back to the search results page ↶

Move the mouse pointer over the control,

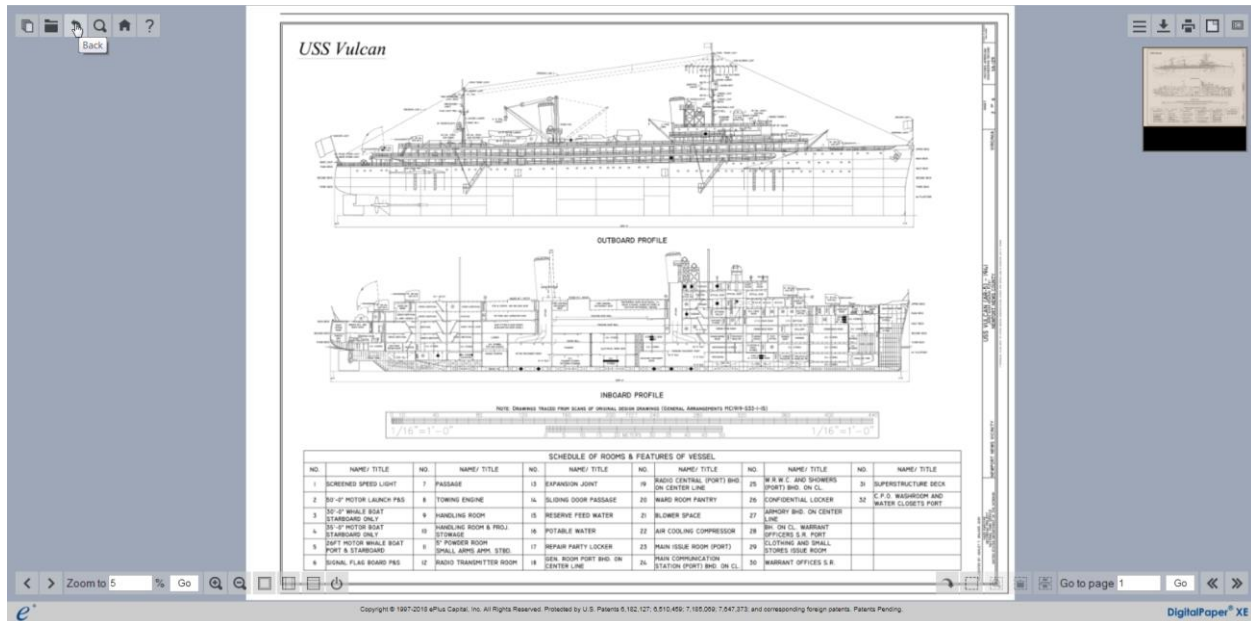

then click. The search results page will be displayed:

Document Search Results [21 found] New Search View Cart (0)

Select All Print Download Add to Cart Delete Display Condensed ▾

Document Attributes	Revision	Action
Document ID: USS Vulcan Profile Drawing 2009 XCLASSID:	A	
Document ID: Starry Night 15000x11878 XCLASSID:	A	
Document ID: Sample ANSI D Document XCLASSID:	A	
Document ID: USS Vulcan XCLASSID:	A	
Document ID: Sample 94" x 66" Document XCLASSID:	A	
Document ID: Consumer Action Handbook XCLASSID:	A	
Document ID: ECMAScript® 2015 Language Specification XCLASSID:	A	
Document ID: ECMAScript® 2015 Language Specification XCLASSID:	B	
Document ID: 12345 XCLASSID:	A	
Document Number: 318851 Sheet Number: 1 Document Name: Document name is here Date: Comment:	A	

Begin a new search

Move the mouse pointer over the control,

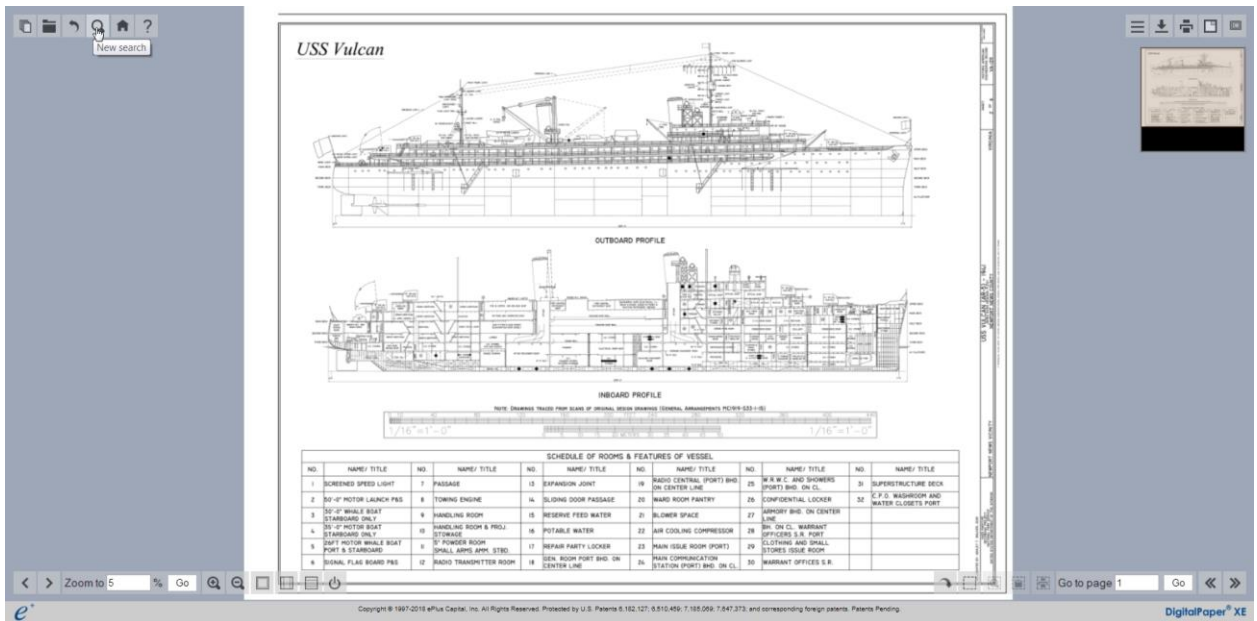

then click. The search page will be displayed:

Search For Documents Select Cabinet: All ▾

Fill in one or more of the following fields. Hint: 123* finds all documents starting with 123

Document Number

Document Revision

Type of search Match Any Field Match All Fields

Display results as Condensed Thumbnail Sorted

Number of results per page

Include archived documents

Automatically view if only one result is found

Go to the XE home page 

Move the mouse pointer over the control,

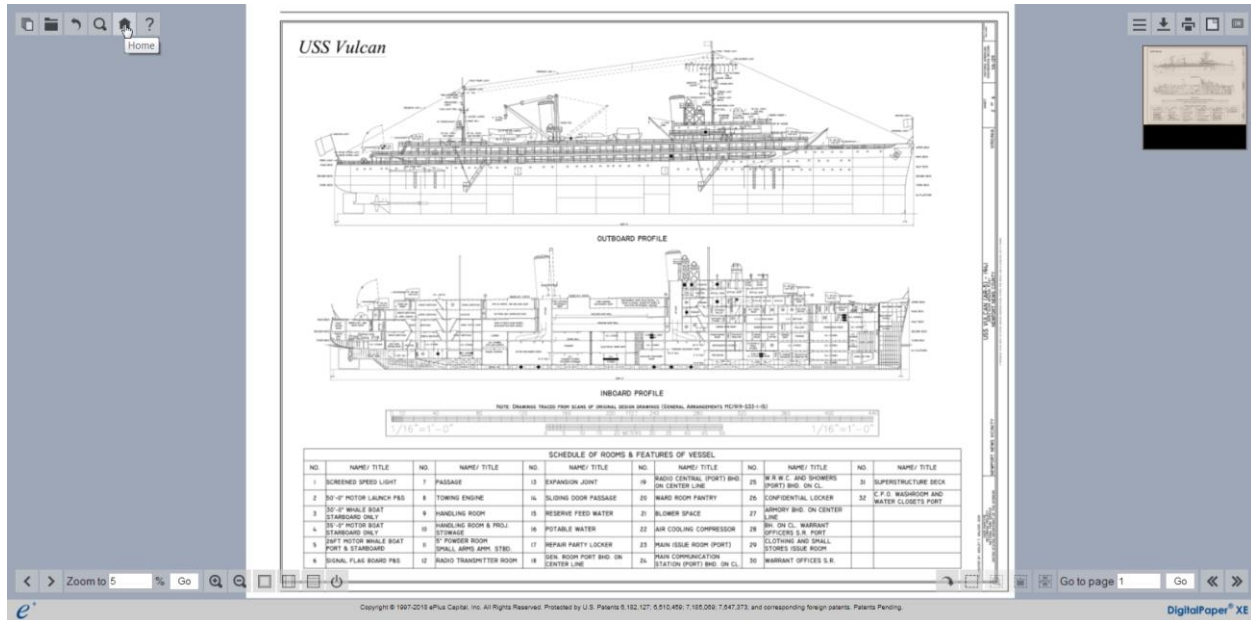

then click. The home page will be displayed:

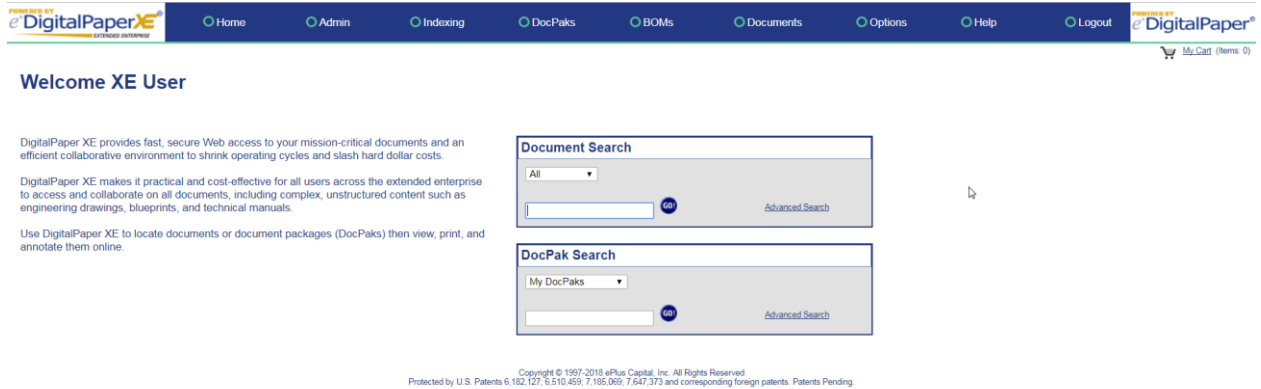

Go to the XE Viewer help page ?

Move the mouse pointer over the control,

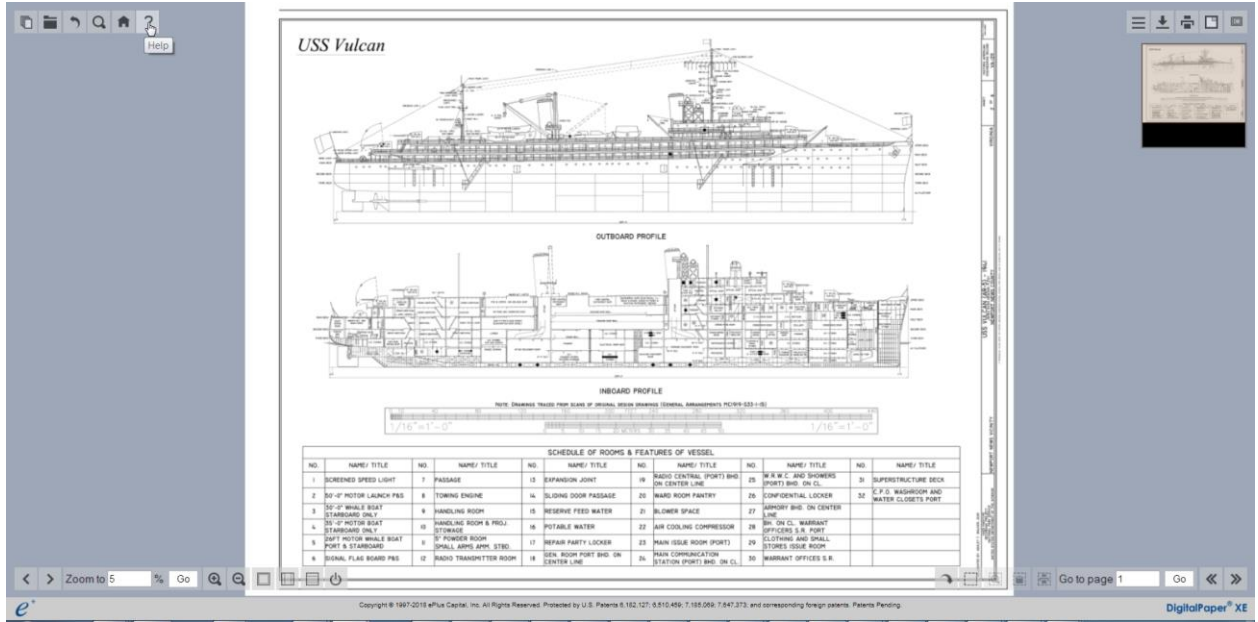

then click. The help popup will appear.

DPXE Viewer

The DPXE viewer is a contemporary implementation of the functions and features available in the classic Digital Paper document viewer.

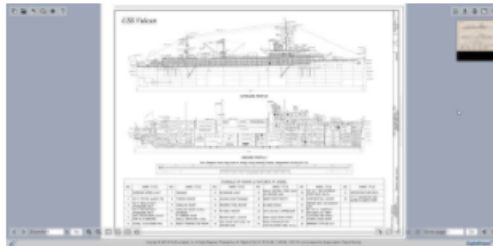

Main Window

The main window of the viewer consists of a single view pane with groups of view and action controls:



Control Groups

The controls are grouped as follows:

<i>Menu Function Navigation</i>	
	Go to a page within the document
	Go to a document in the search result set

Tip: Expand the width of the popup to see more details in the screen captures:

DPXE Viewer

The DPXE viewer is a contemporary implementation of the functions and features available in the classic Digital Paper document viewer.

Main Window

The main window of the viewer consists of a single view pane with groups of view and action controls:

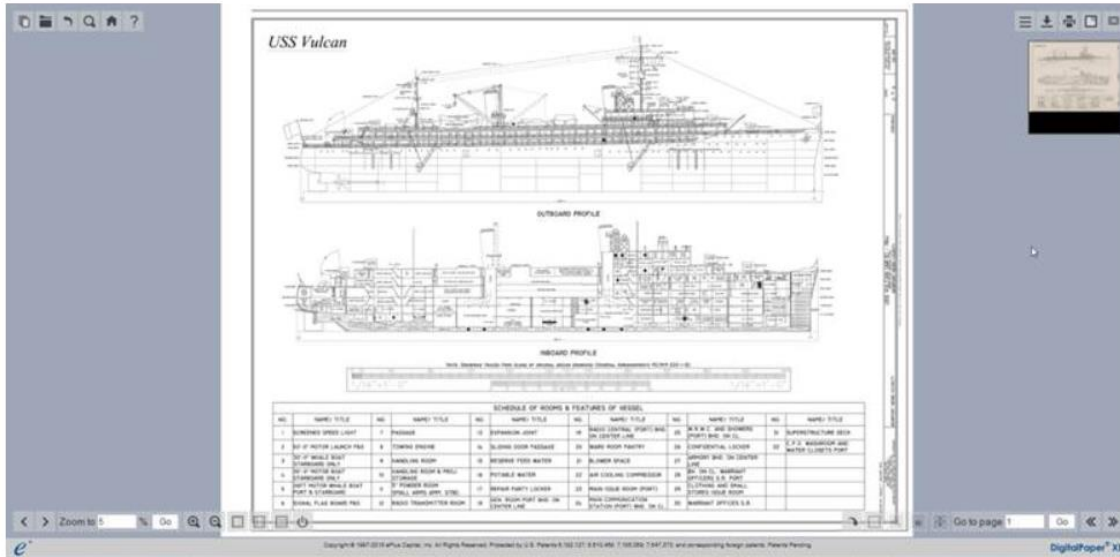

Control Groups

Document Function Navigation

The document function navigation controls are used as follows:

Show the document's properties

Move the mouse pointer over the control,

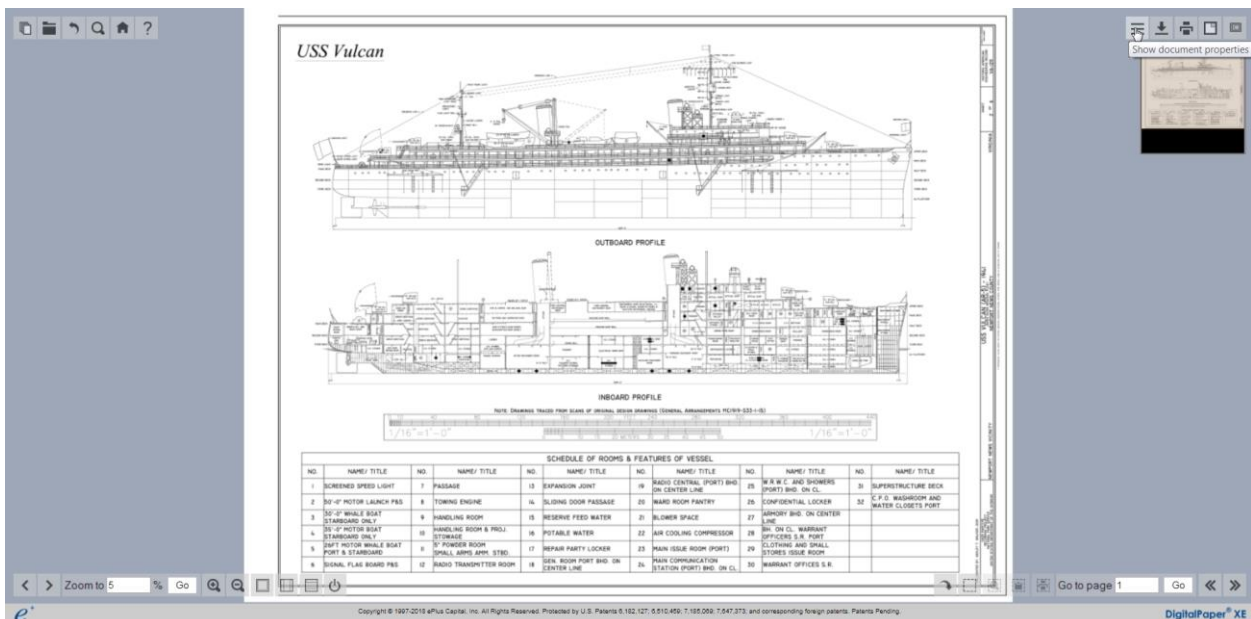

then click. The document properties popup will be displayed:

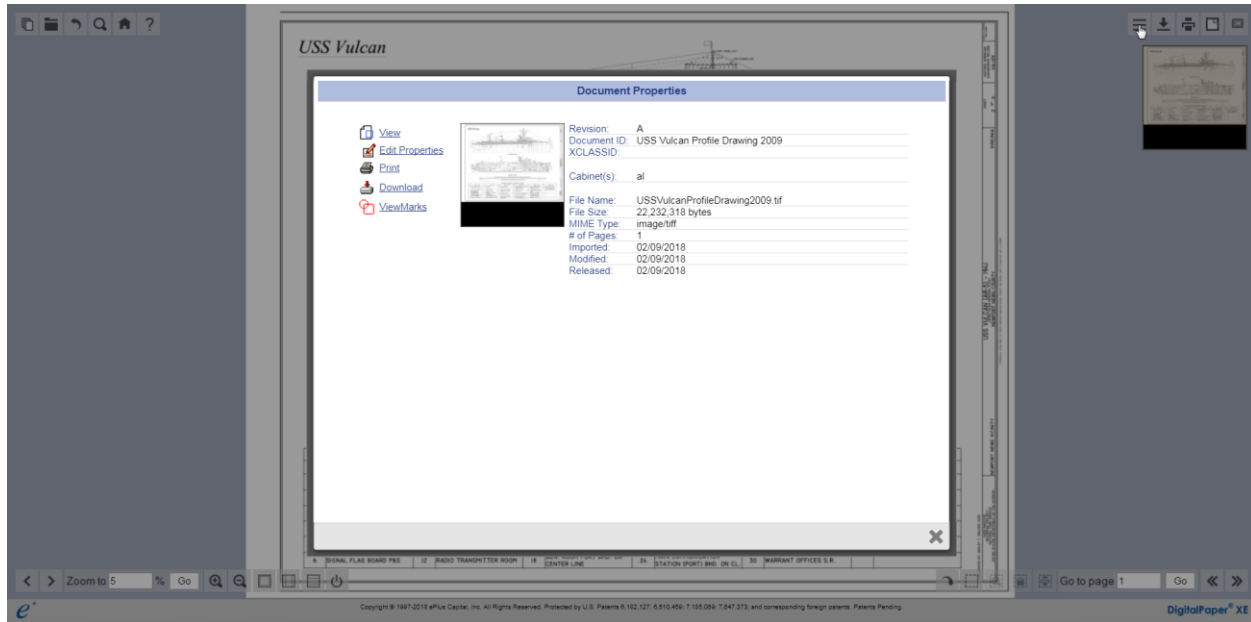

See *View Document Properties* in the *Enterprise User's Guide* for more information.

Download the document 

Move the mouse pointer over the control,

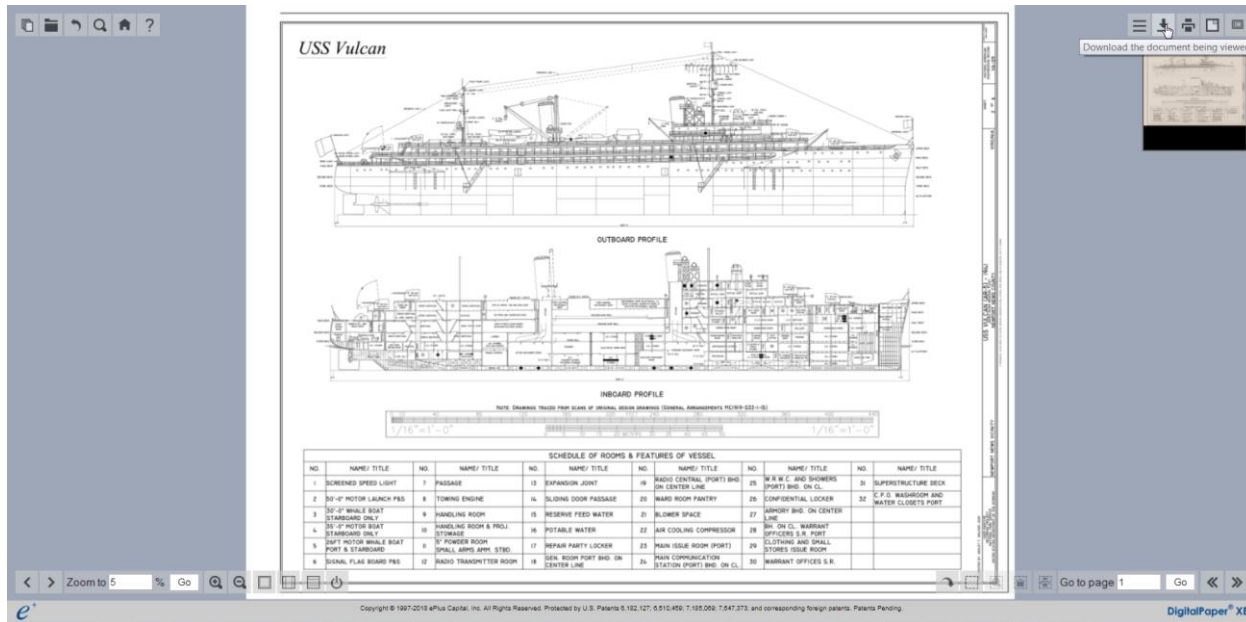

then click. The download document popup (the specific fields you see may be different depending on the DPXE configuration) will appear:

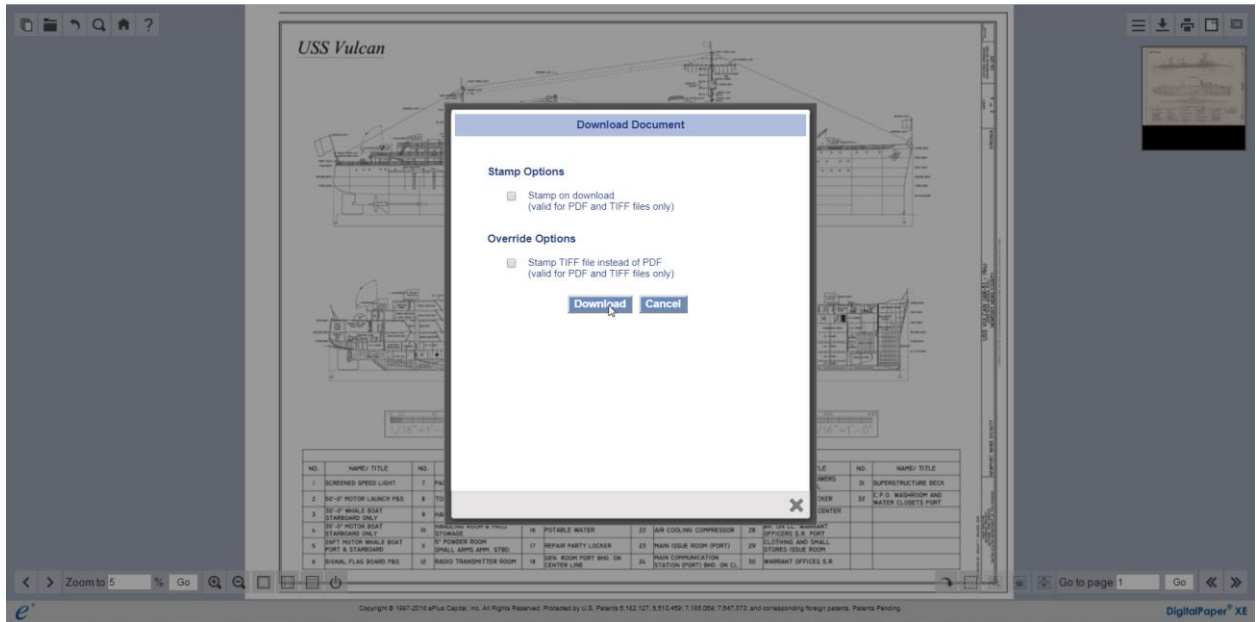

Click the *Download* button to begin the download.

See *Download a Document* in the *Enterprise User's Guide* for more information.

Print the document 

Move the mouse pointer over the control,



then click. The print document popup (the specific fields you see may be different depending on the DPXE configuration) will appear:

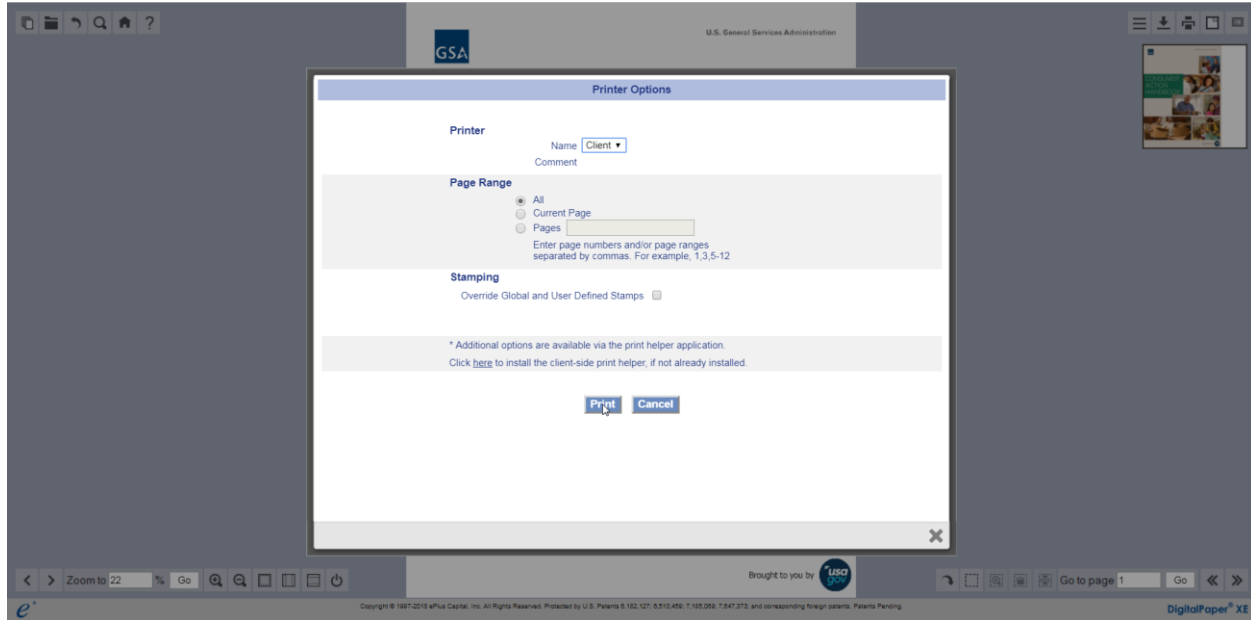

Click **Print** to begin printing.

See *Printing a Document* in the *Enterprise User's Guide* for more information.

Toggle the Bird's Eye View 

Move the mouse pointer over the control,

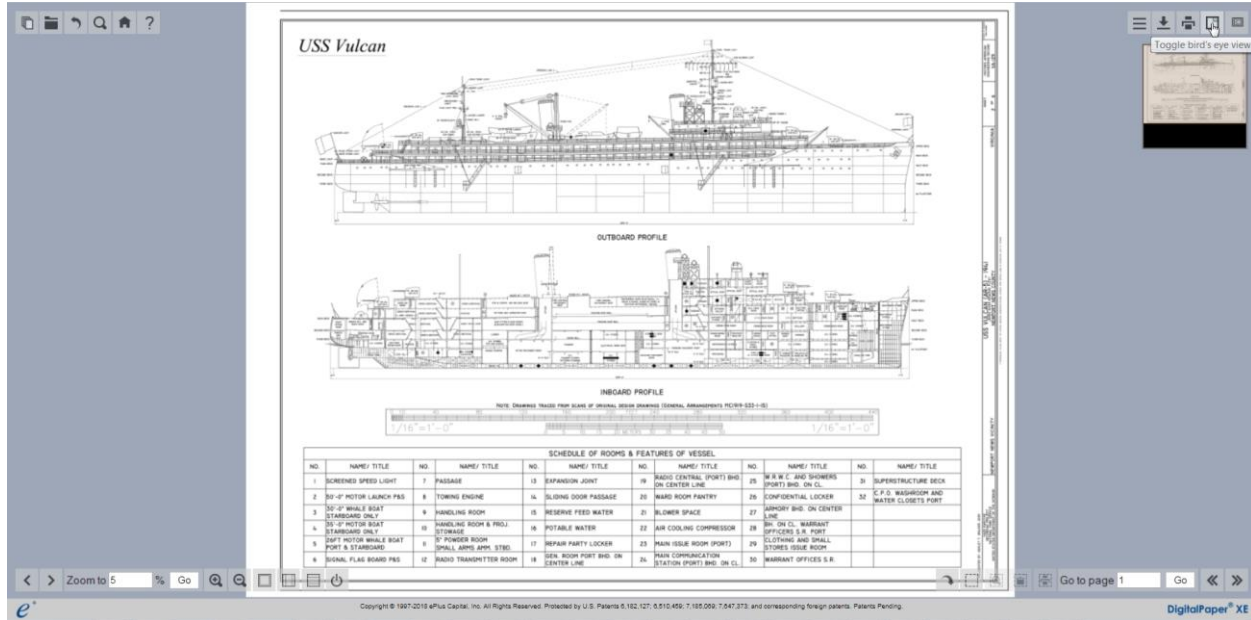

then click. The bird's eye view will either disappear, if it is currently in view (as shown in this example) or appear, if it is currently invisible:

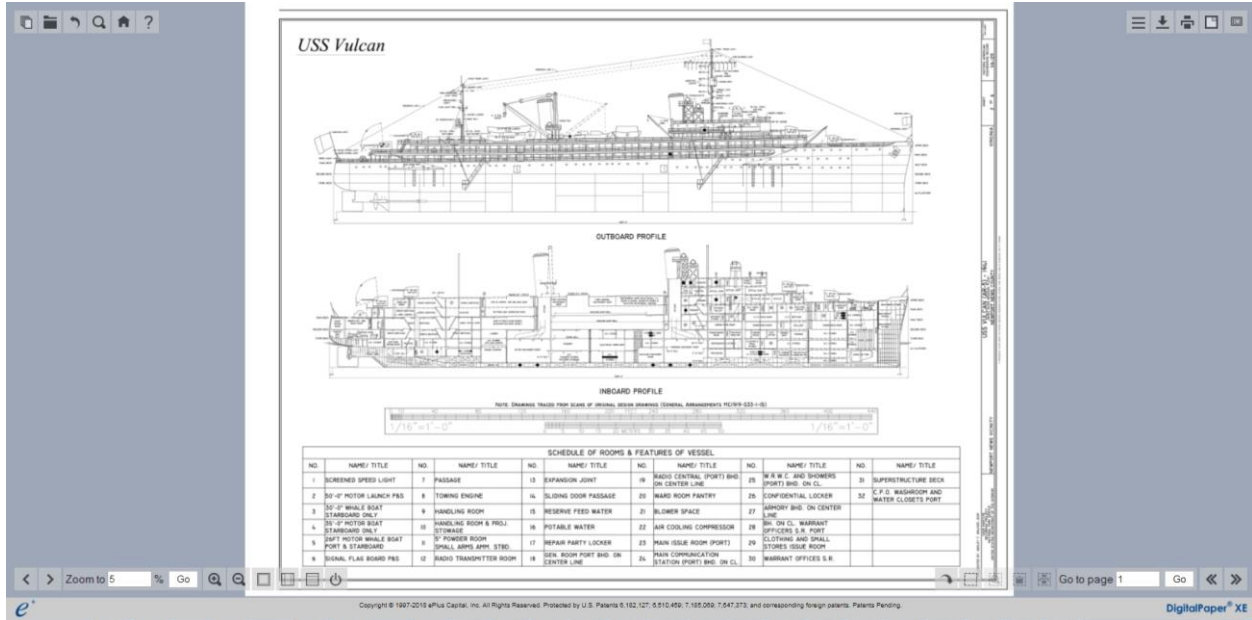

View the document in the classic viewer

Move the mouse pointer over the control,

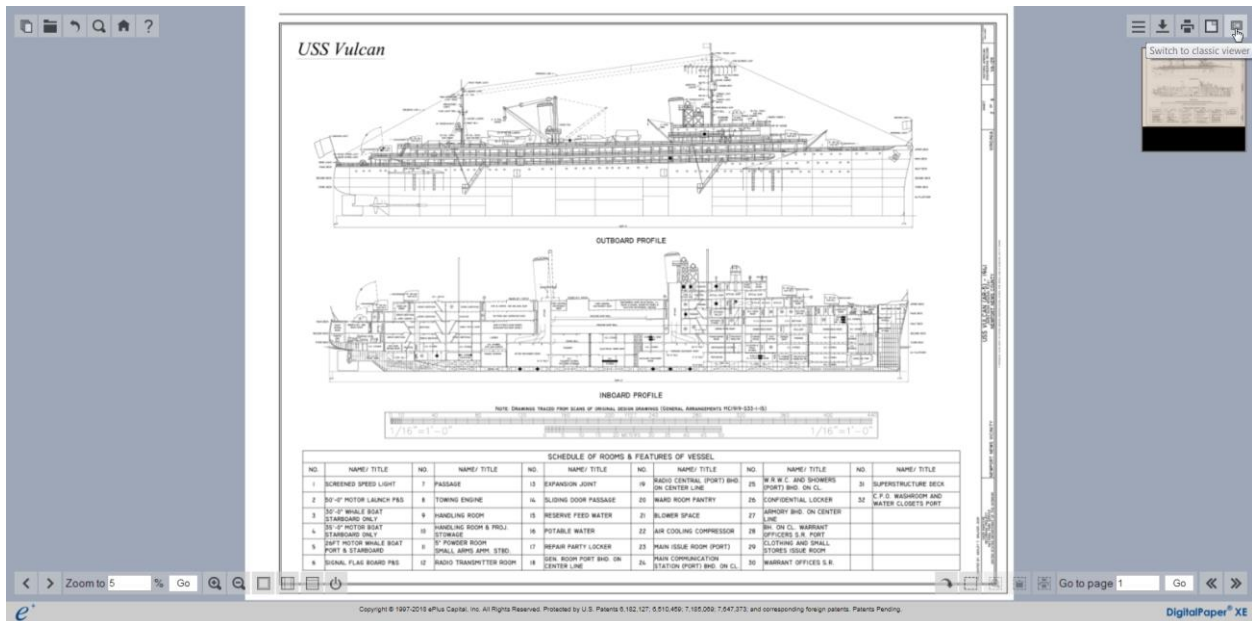

then click. The document will open in the classic viewer:

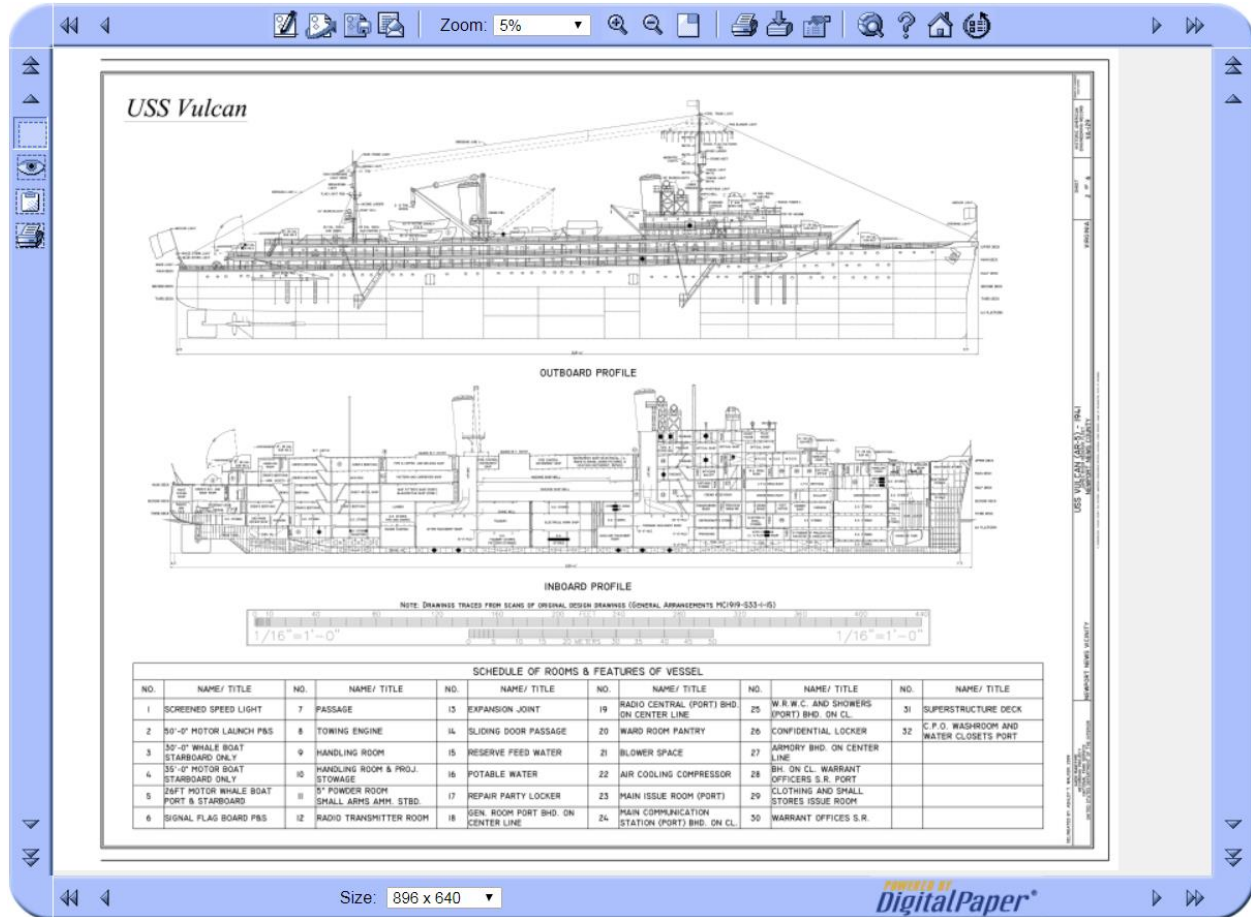

Page View Controls

The page view controls are used as follows:

View the previous page in the document ◀

When viewing a multiple page document, move the mouse pointer over the control,

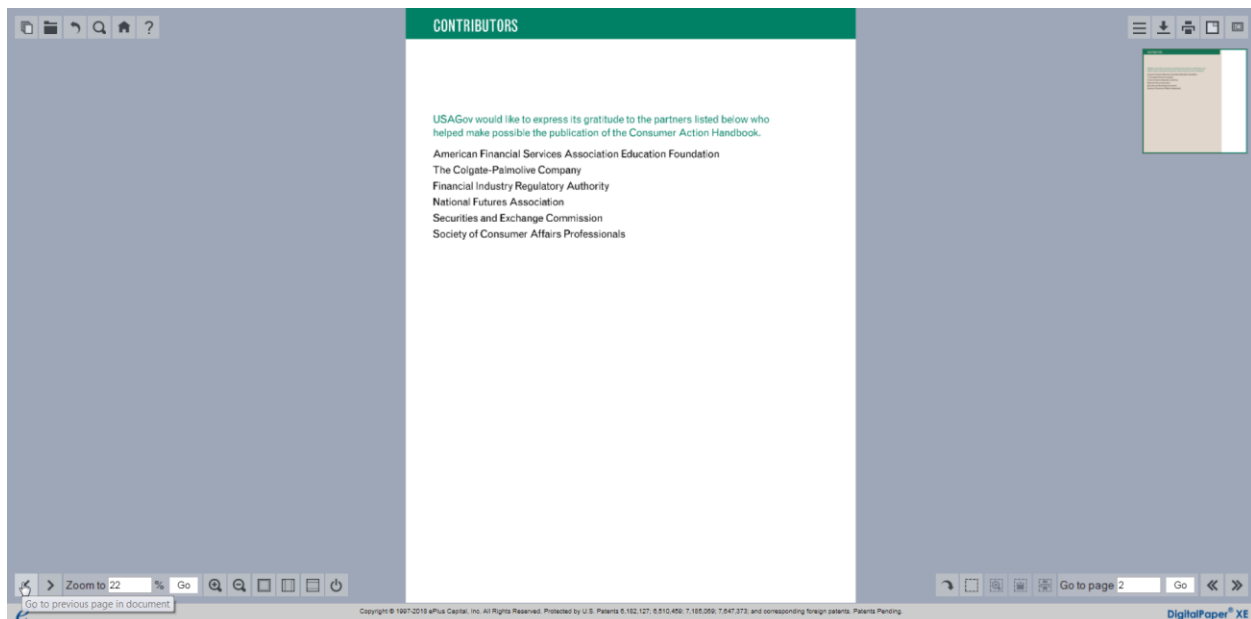

then click. The previous page in the document will be displayed:

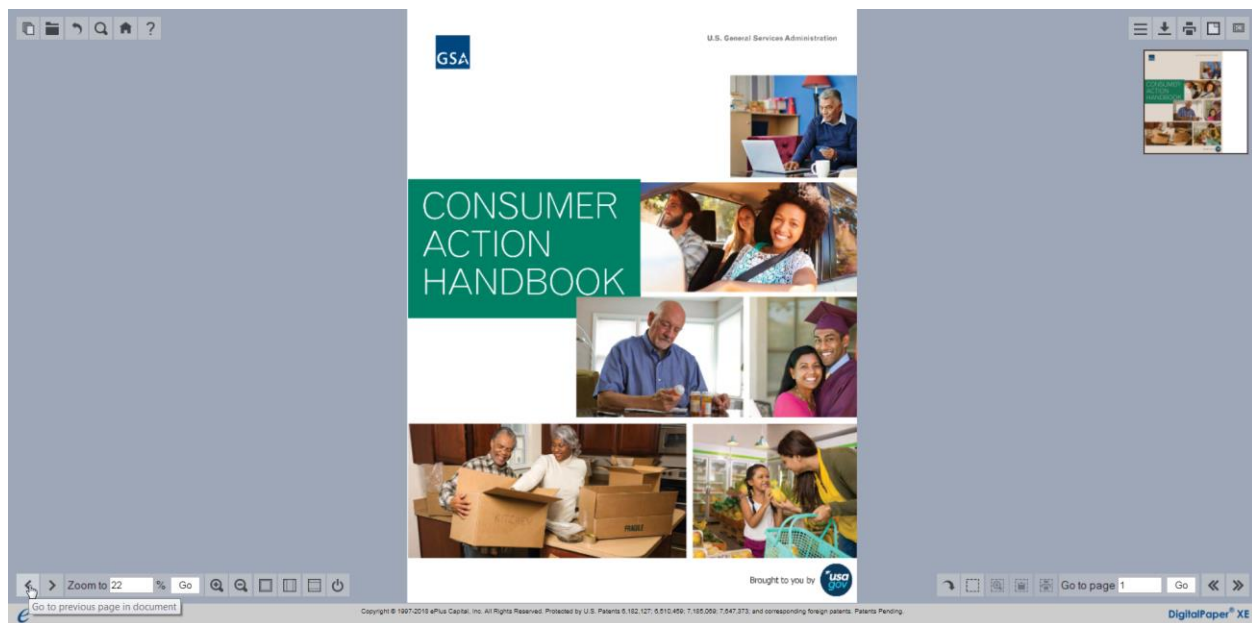

View the next page in the document >

Move the mouse pointer over the control,

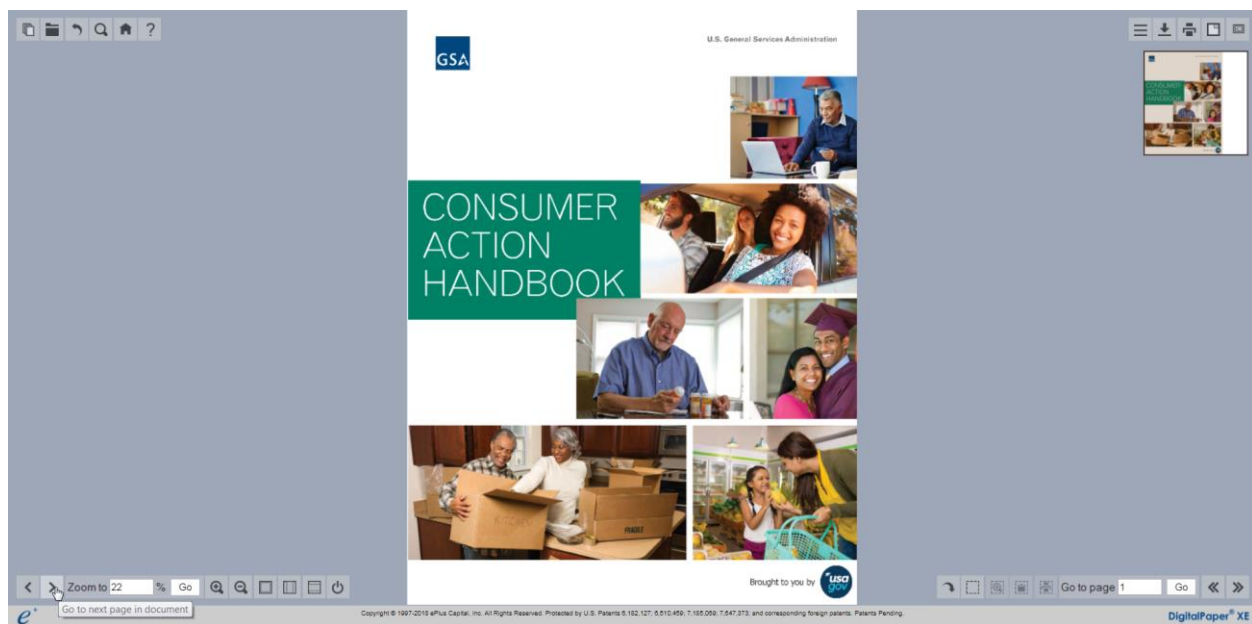

then click. The next page in the document will be displayed:

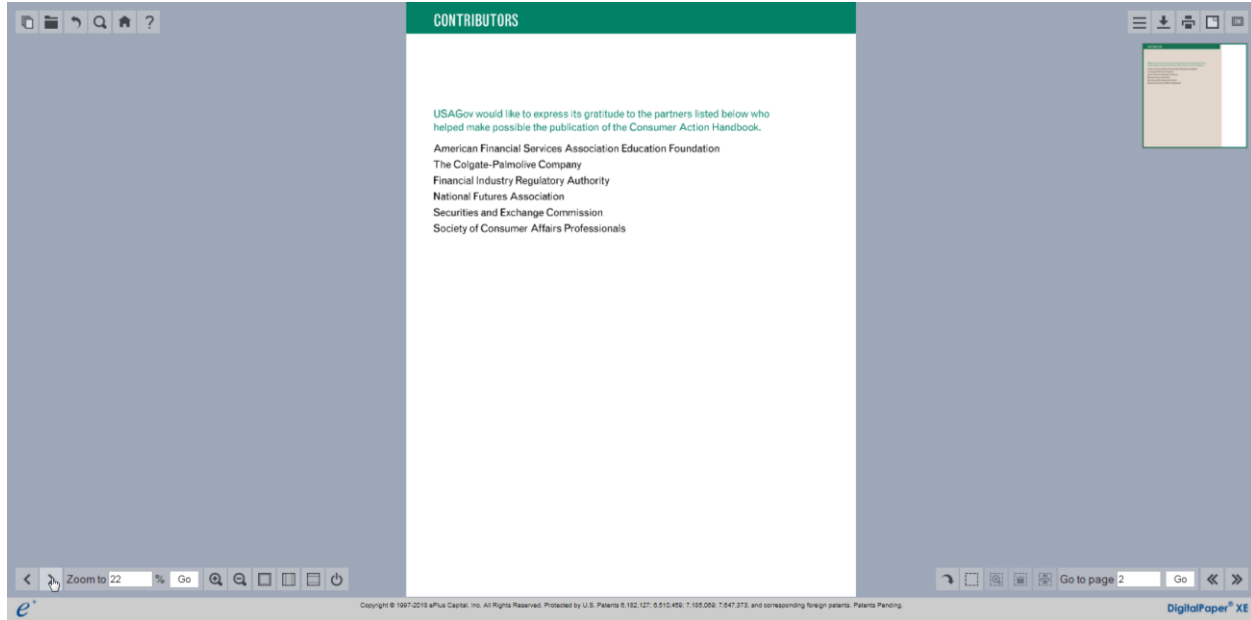

Zoom in

Move the mouse pointer over the control,

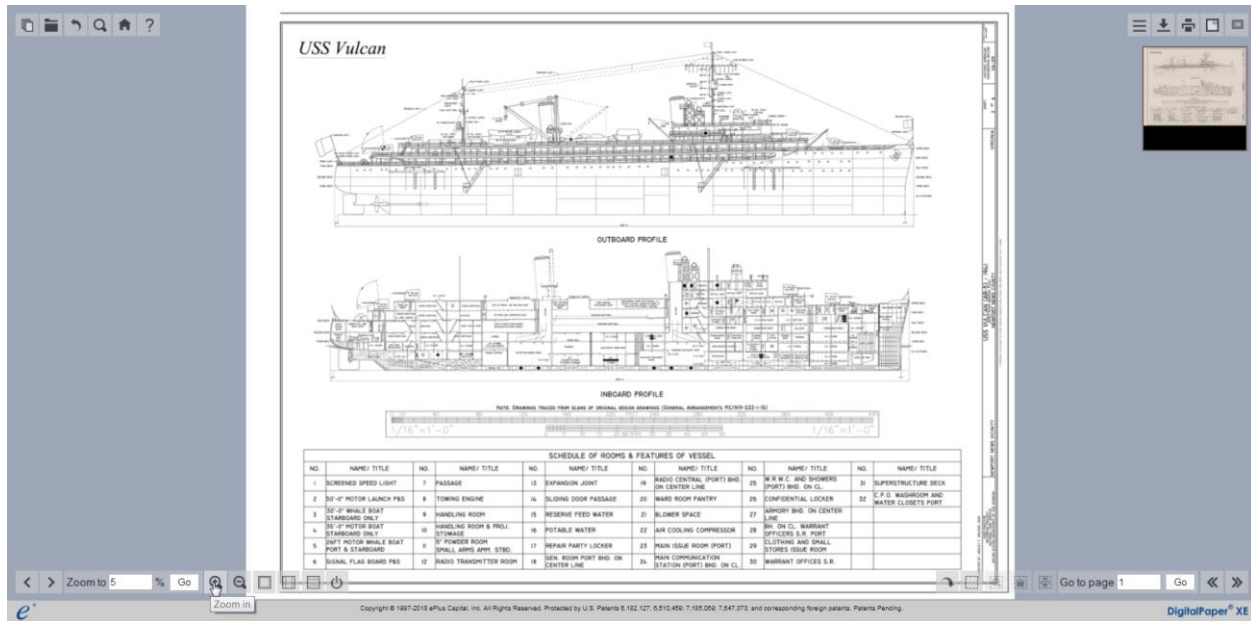

then click. The image view will be zoomed in, using the center of the area currently displayed as the area around which to zoom:

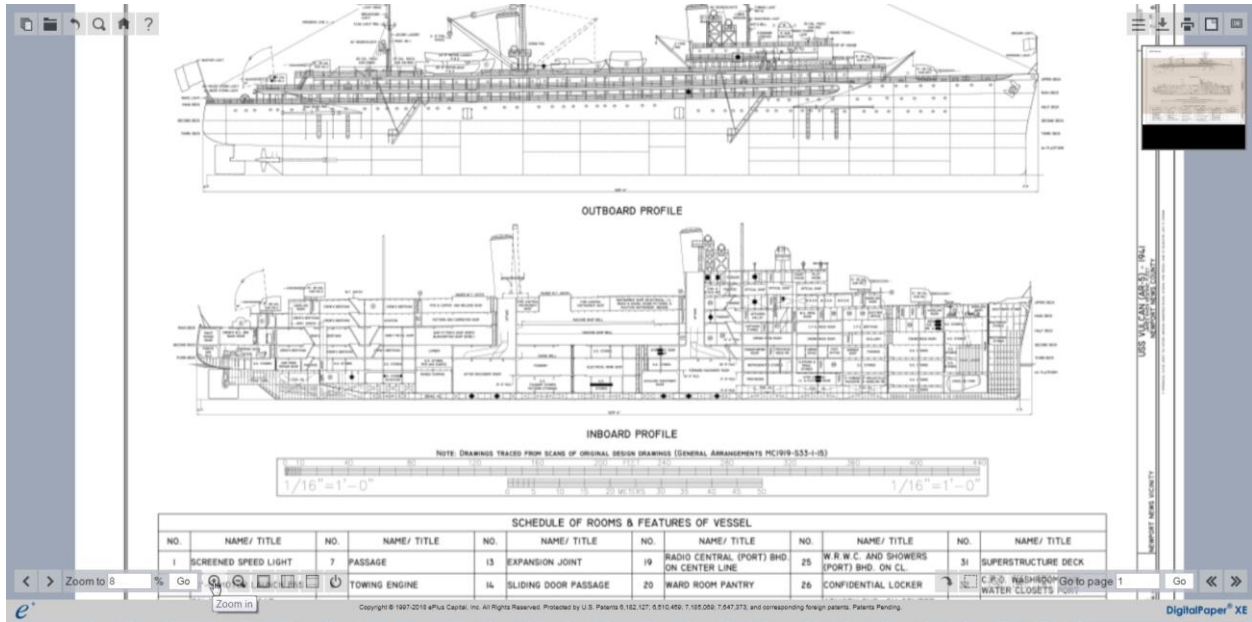

Zoom out

Move the mouse pointer over the control,

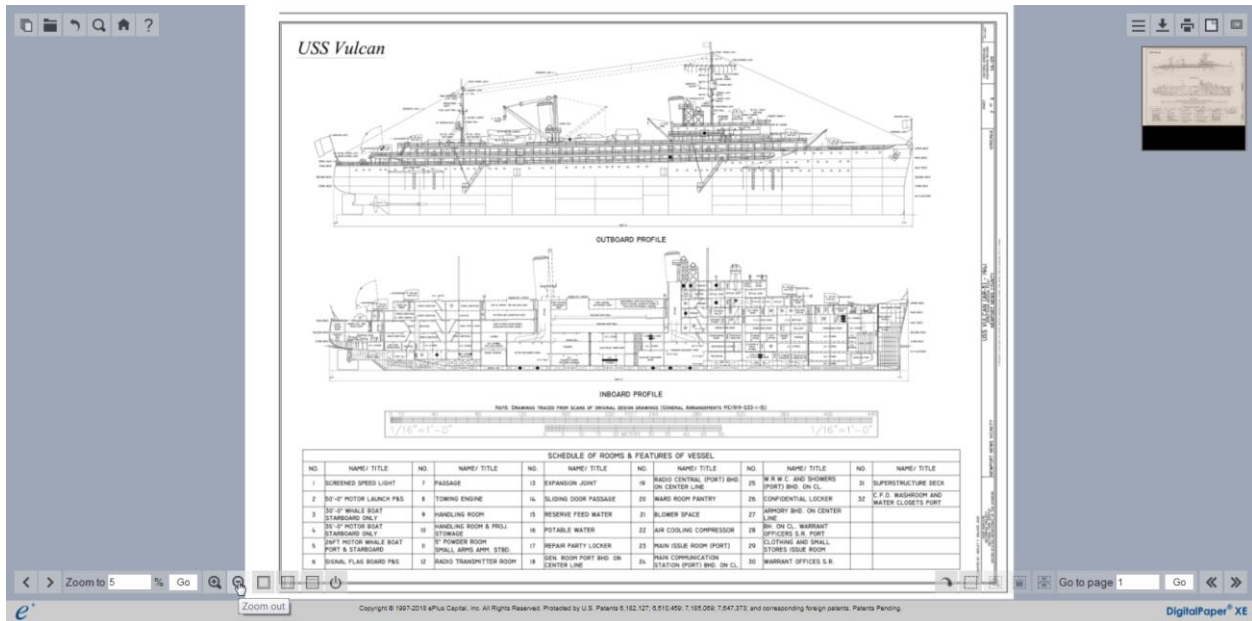

then click. The image view will be zoomed out, using the center of the area currently displayed as the area around which to zoom:

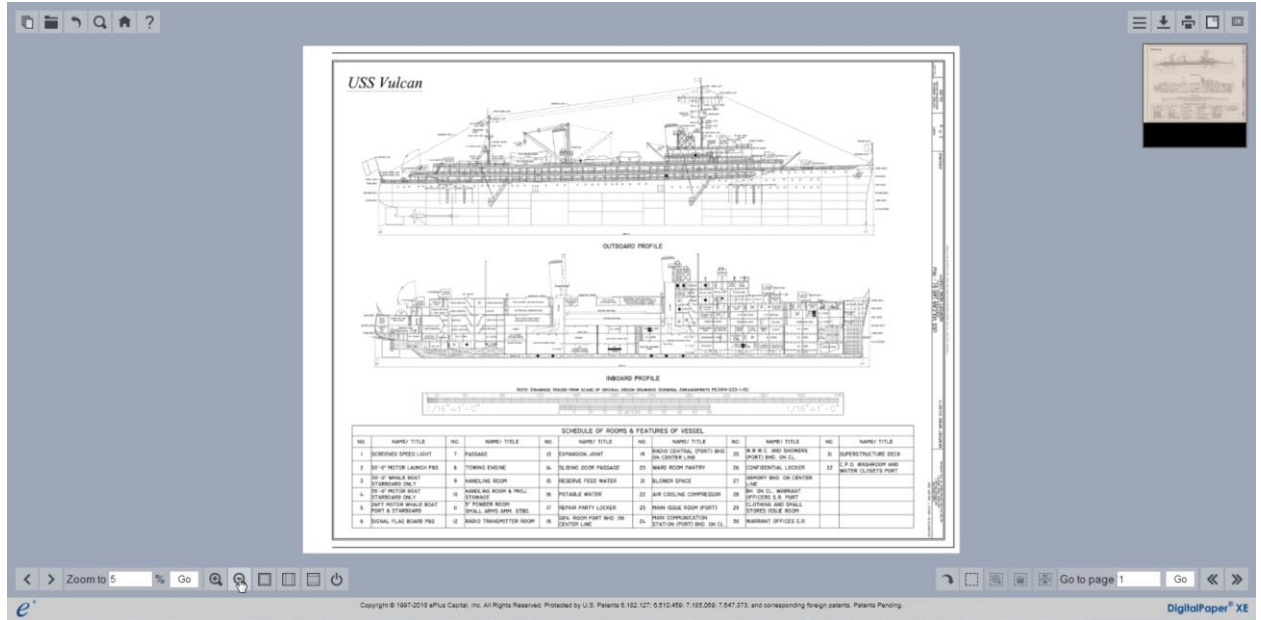

Fit to page

Move the mouse pointer over the control,

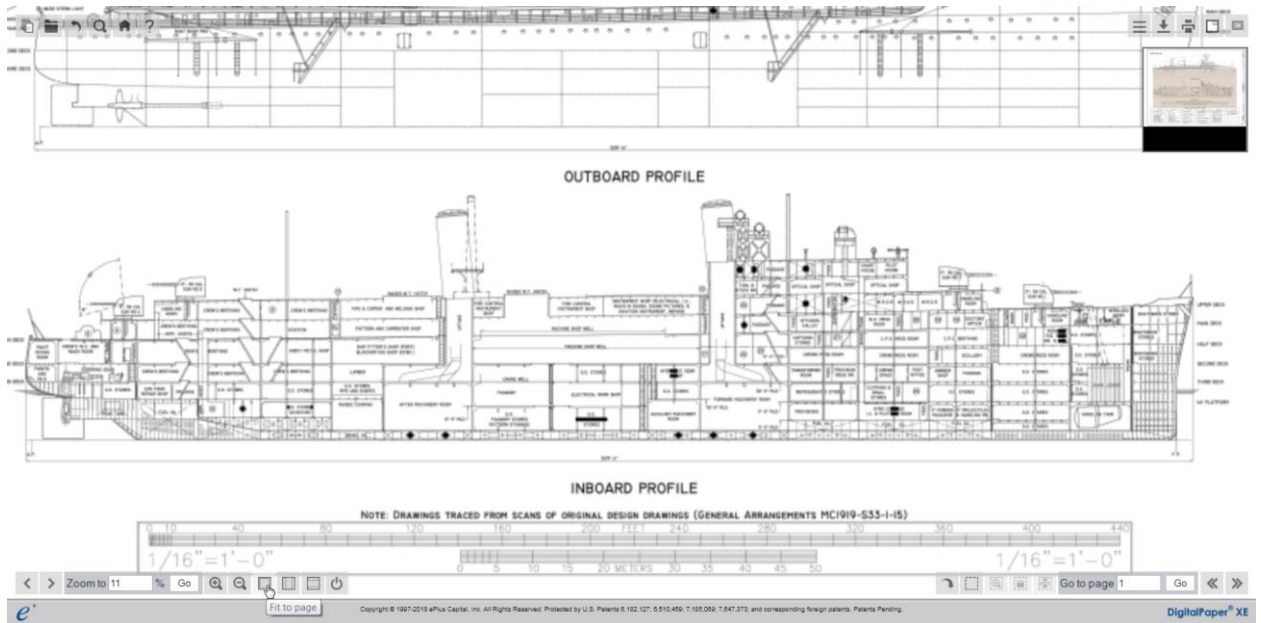

then click. The image will be redrawn so the entire image is visible:

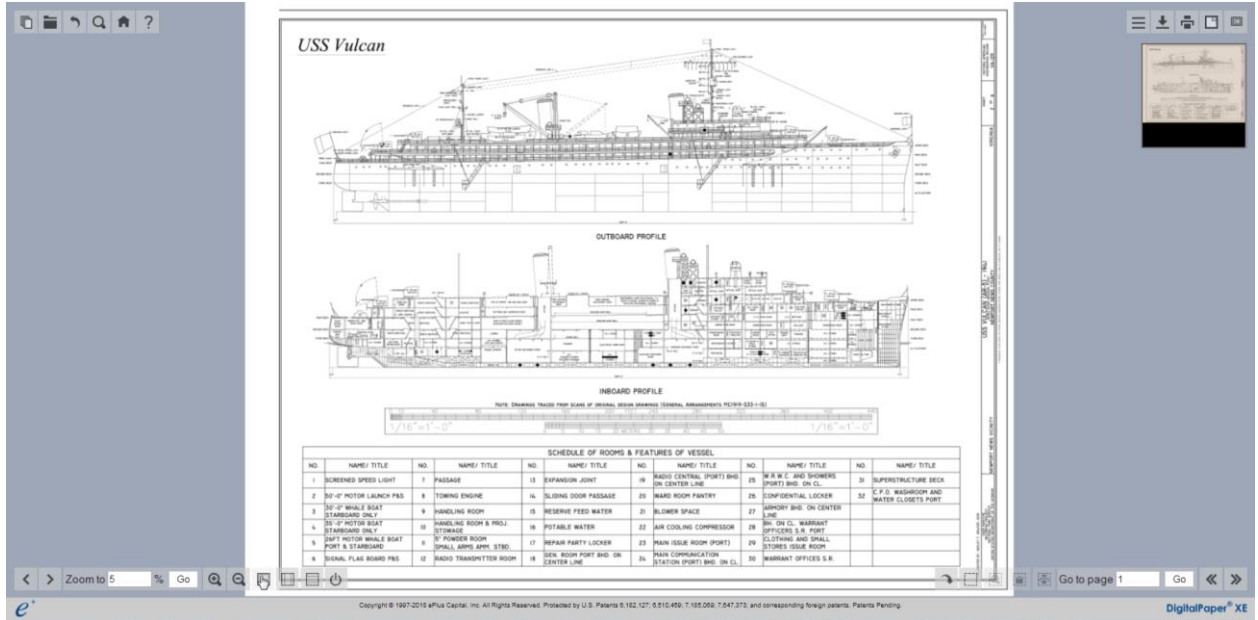

Fit height

Move the mouse pointer over the control,

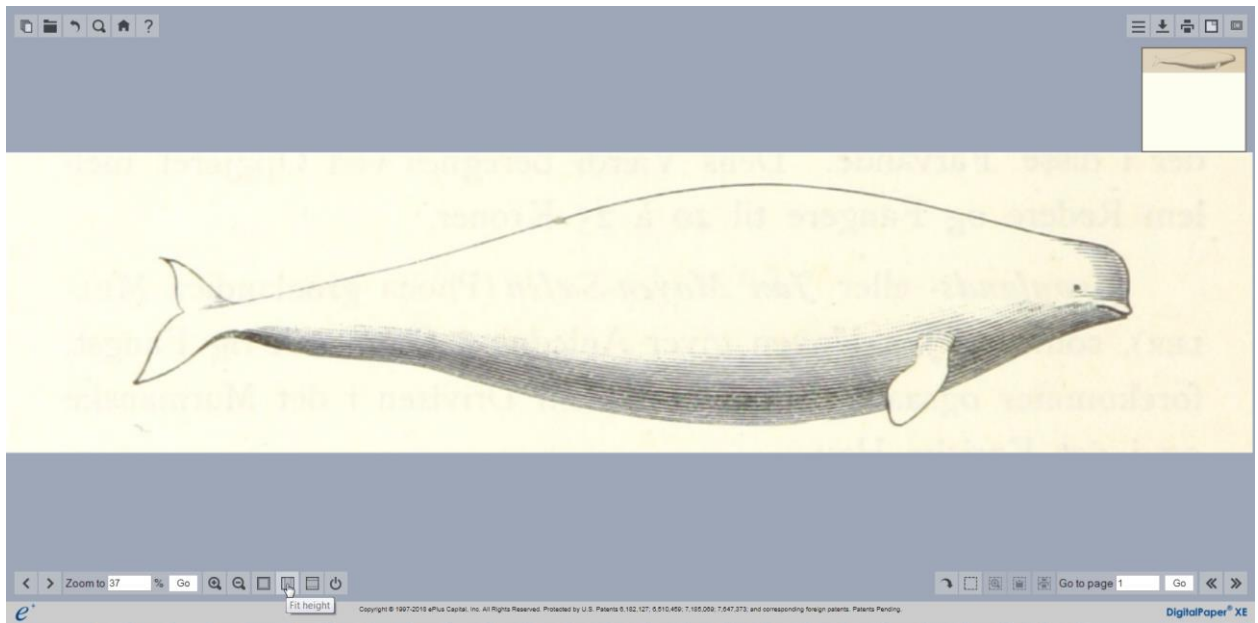

then click. The image will be redrawn so the entire height of the image fills the viewport from top to bottom:

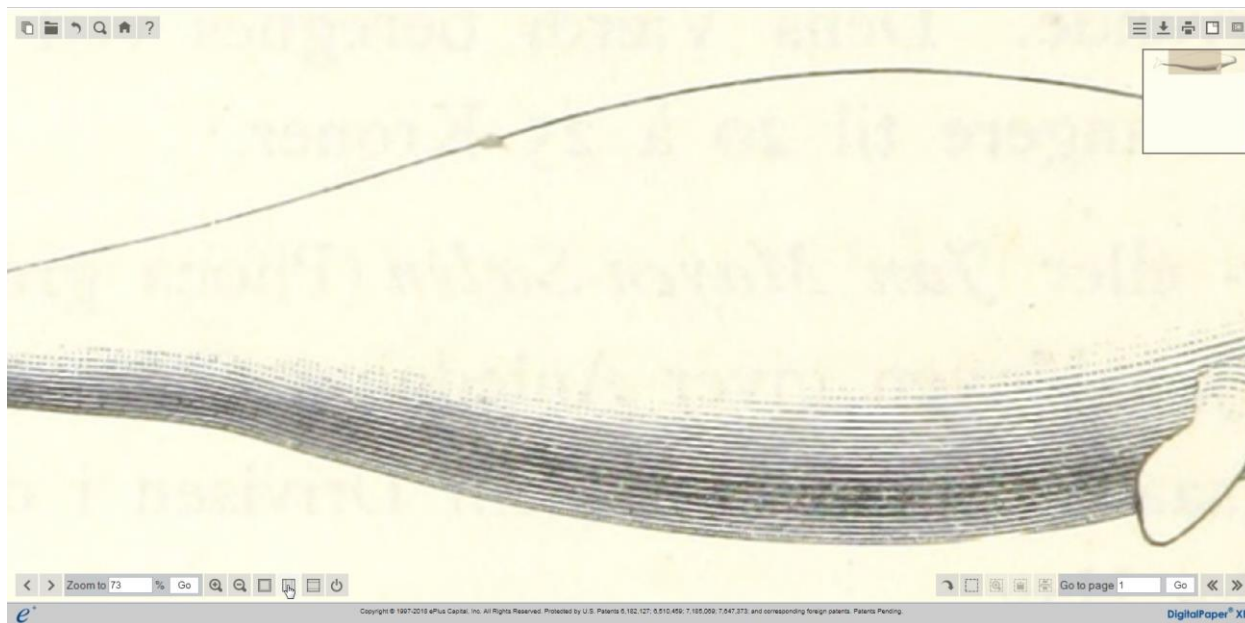

Fit width

Move the mouse pointer over the control,

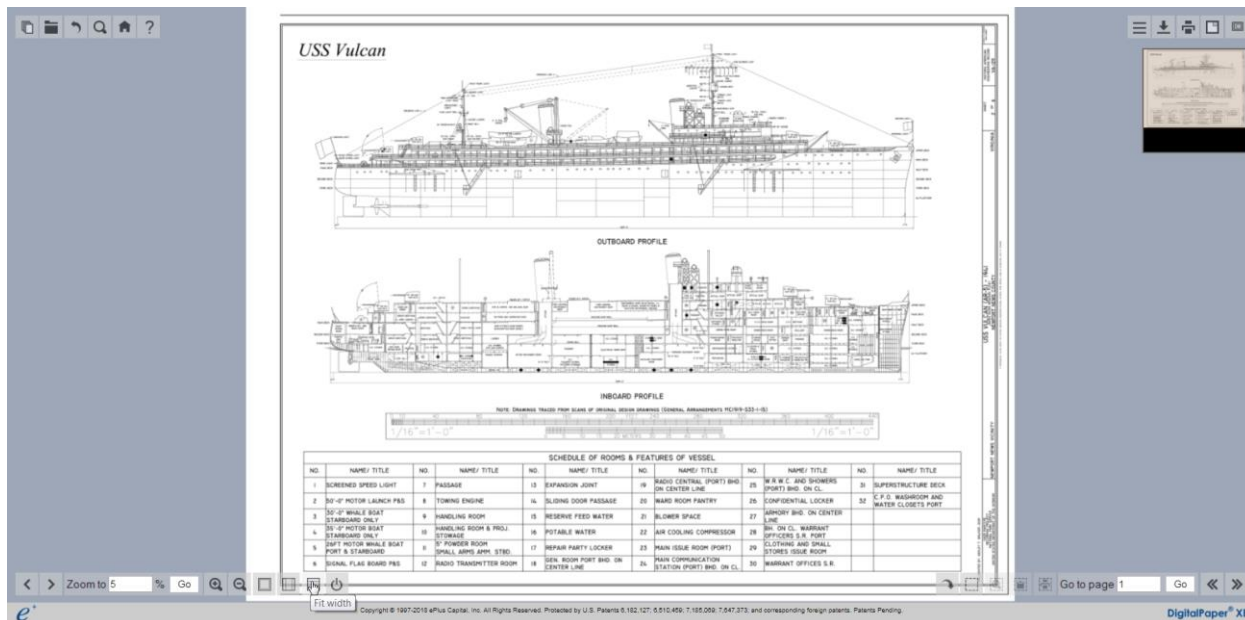

then click. The image will be redrawn so the entire width of the image fills the viewport from left to right:

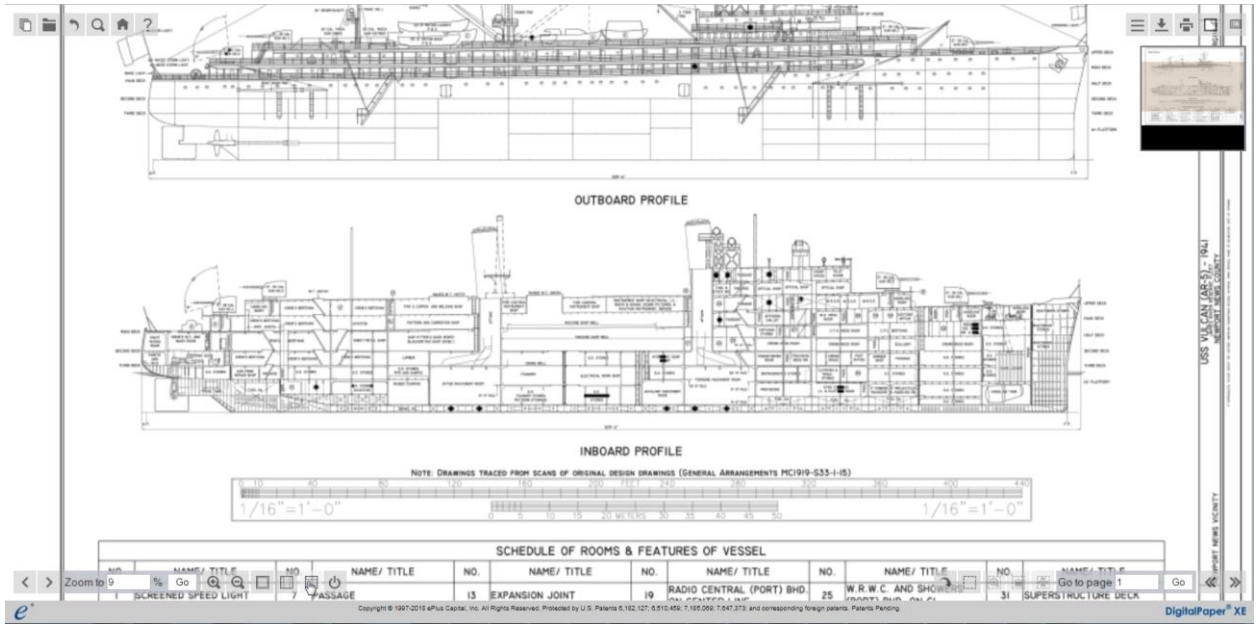

Reset view

Move the mouse pointer over the control,



then click. The image will be redrawn so the entire image is visible in its original rotational orientation:

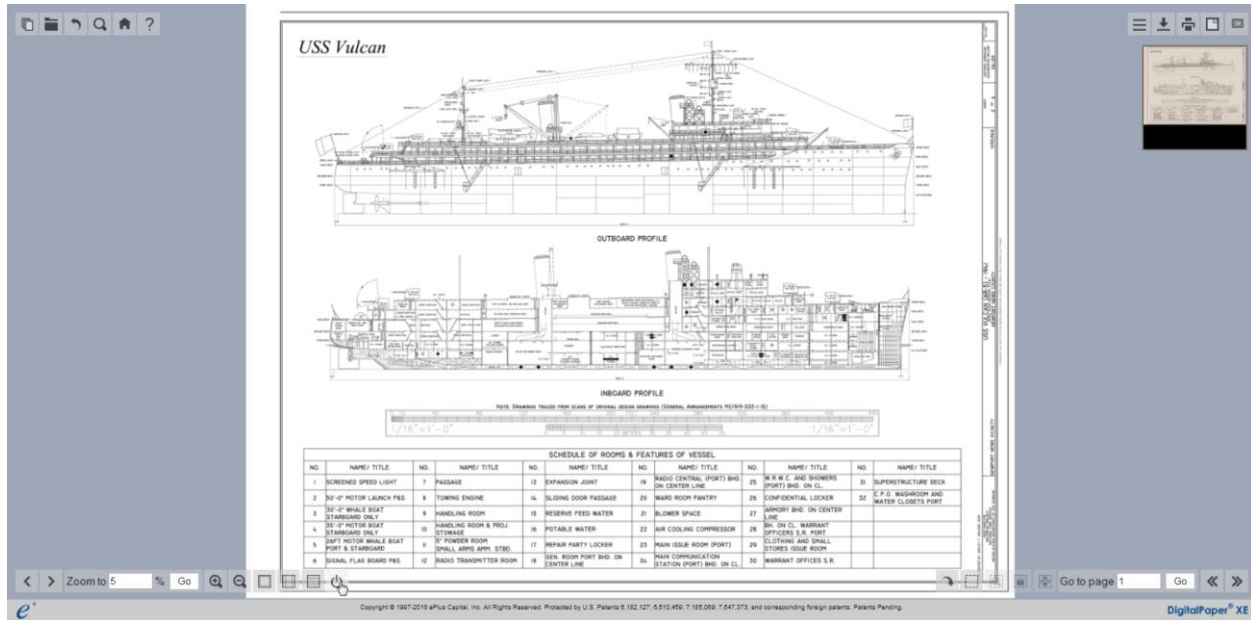

View/Set Zoom Level Zoom to 13 % Go

The *Zoom to* value shows the current size of the image in the viewport as a percentage of the original size of the image.

To change the zoom level to a specific percentage, enter a percentage value (100% = the original size of the image) then press the *Go* button. The image will be redisplayed at that zoom level using the center of the image as it appears on screen as the area around which to zoom.

Example: The image appears as follows onscreen:

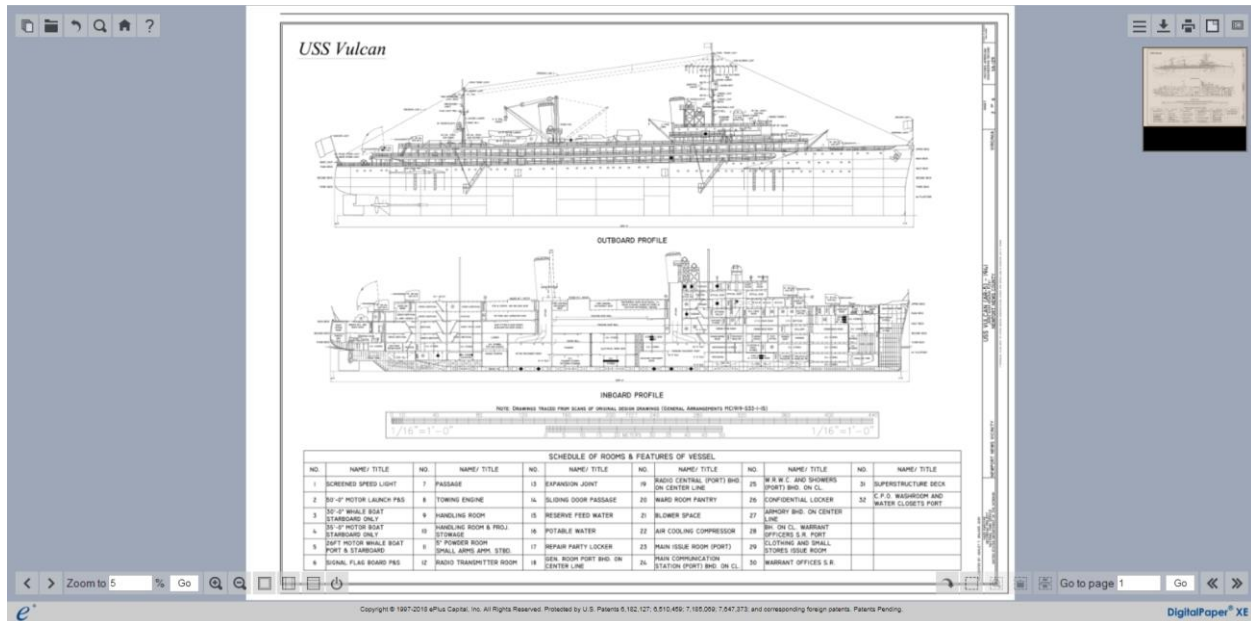

Change the zoom level to 50% then press *Go*.





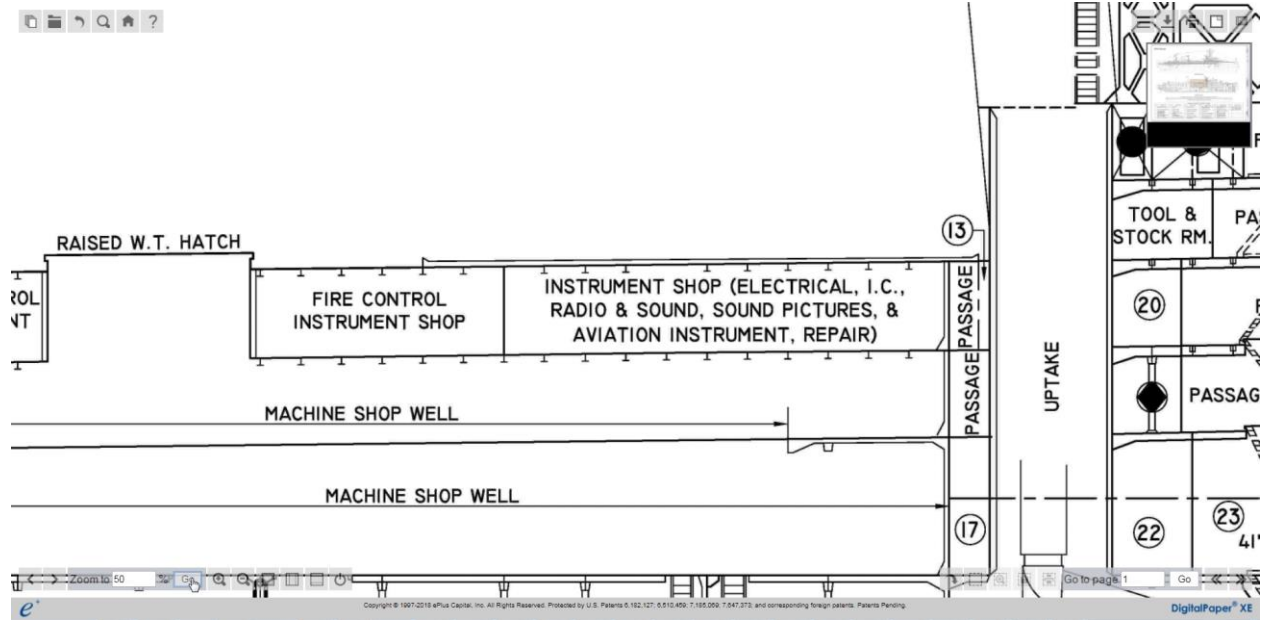





The image will be redisplayed as:



Document View Controls

The document view controls are used as follows:

Document View Controls	
	View the prior document in the search results set
	View the next document in the search results set
	Rotate the view 90 degrees
	Select a region of the image
	Zoom to the selected region
	Copy the selected region to the clipboard
	Print the selected region
The <input type="text" value="Go to page 1"/> <input type="button" value="Go"/> control shows the number of the page in the document currently displayed and provides a way to go directly to a page.	

View the prior document in the search results set 

Move the mouse pointer over the control,

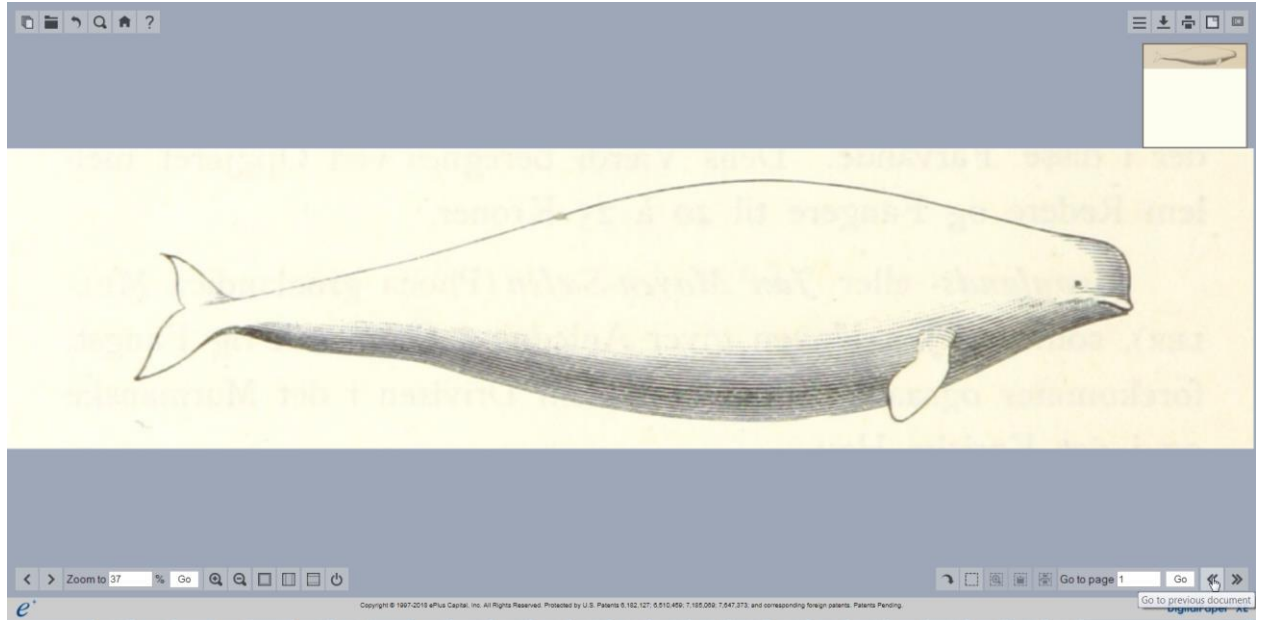

then click. The previous document in the search result set will be displayed.

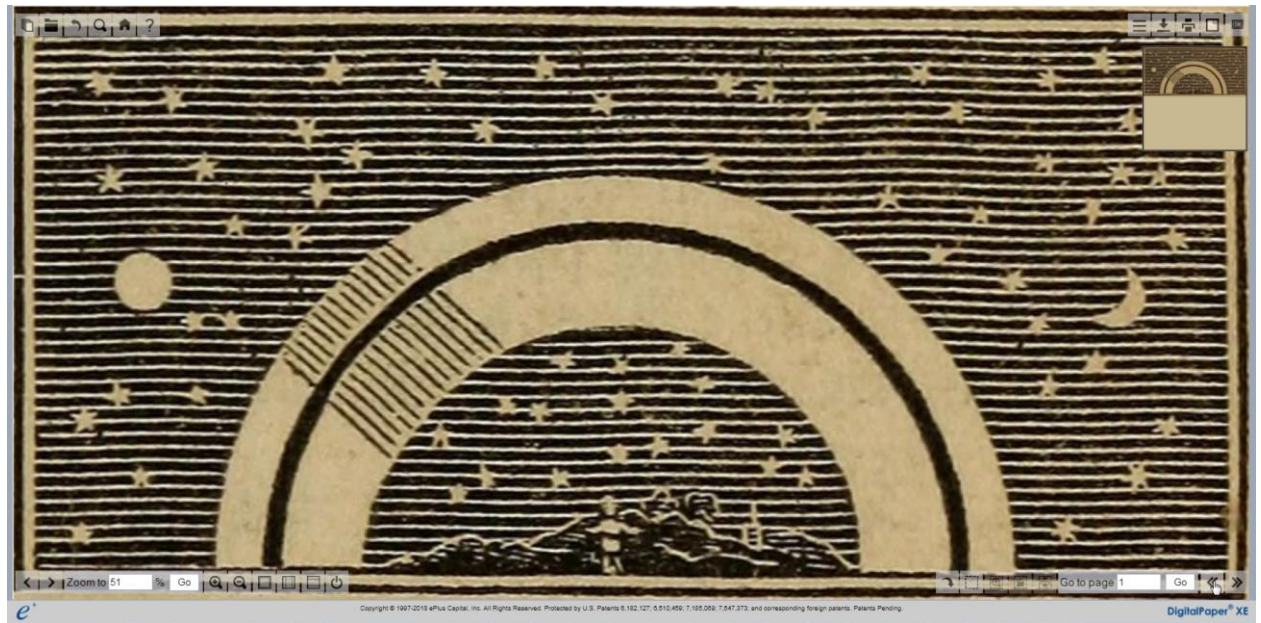

View the next document in the search results set >>

Move the mouse pointer over the control,

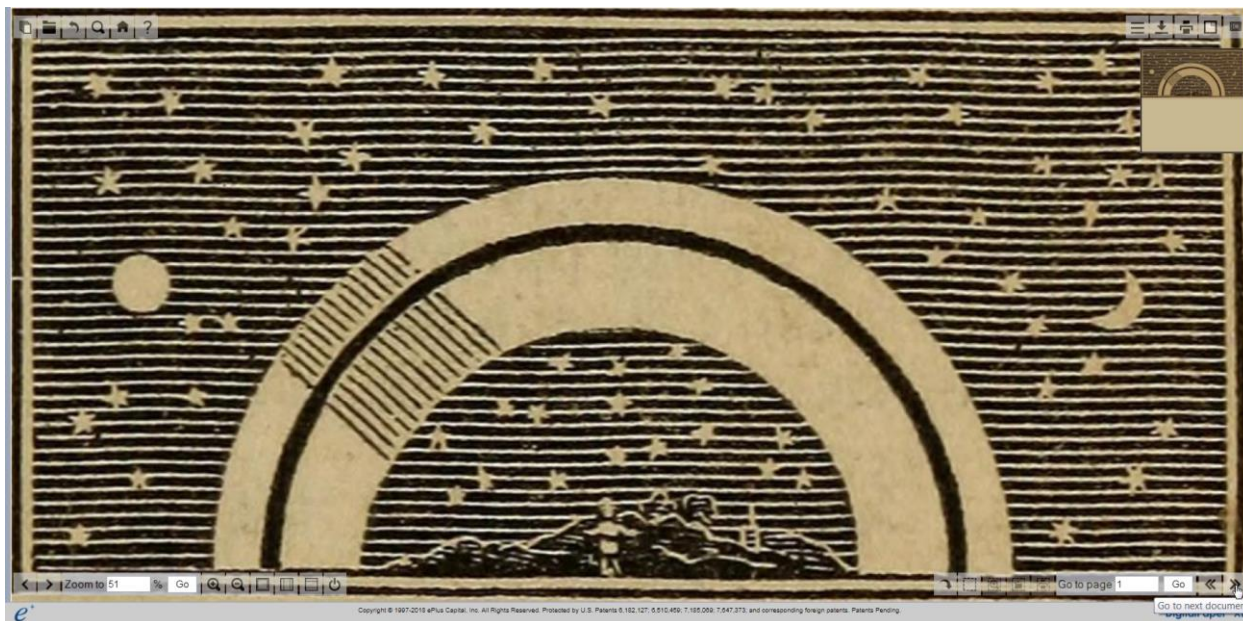

then click. The next document in the search result set will be displayed.

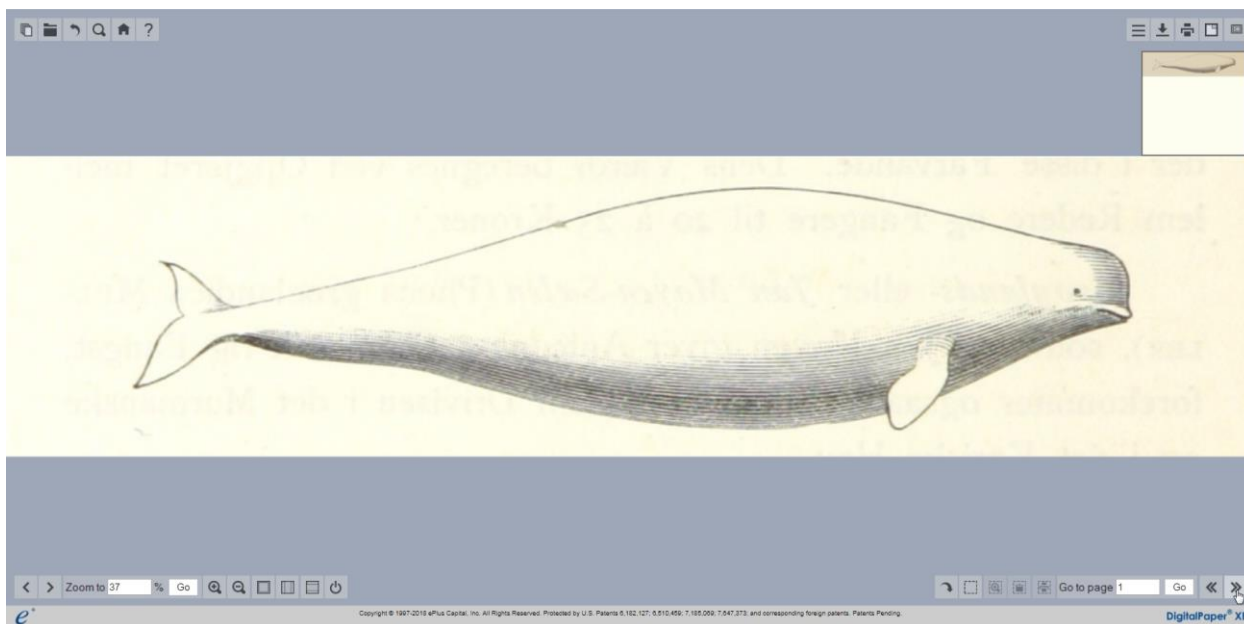

Rotate the view 90 degrees

The *Rotate 90 degrees* control rotates the view of the image 90 degrees each time the control is pressed. (To rotate the view 180 degrees, press the control twice in succession.)

Example: Move the mouse pointer over the control,

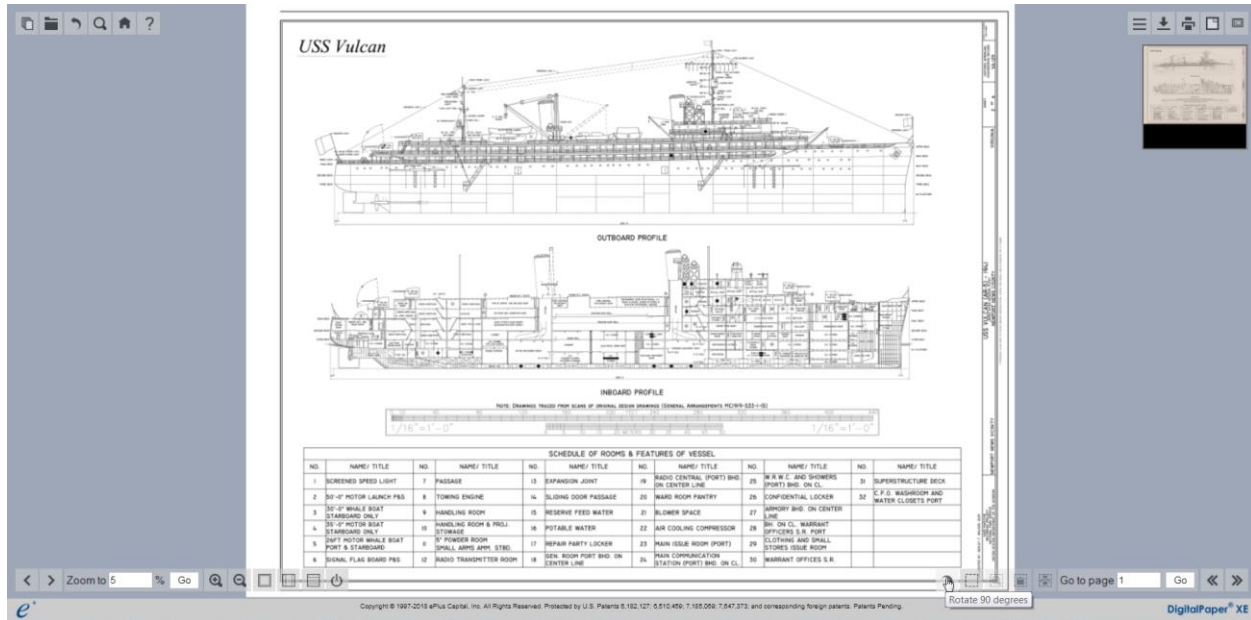

then click. The view of the image will be rotated 90 degrees.

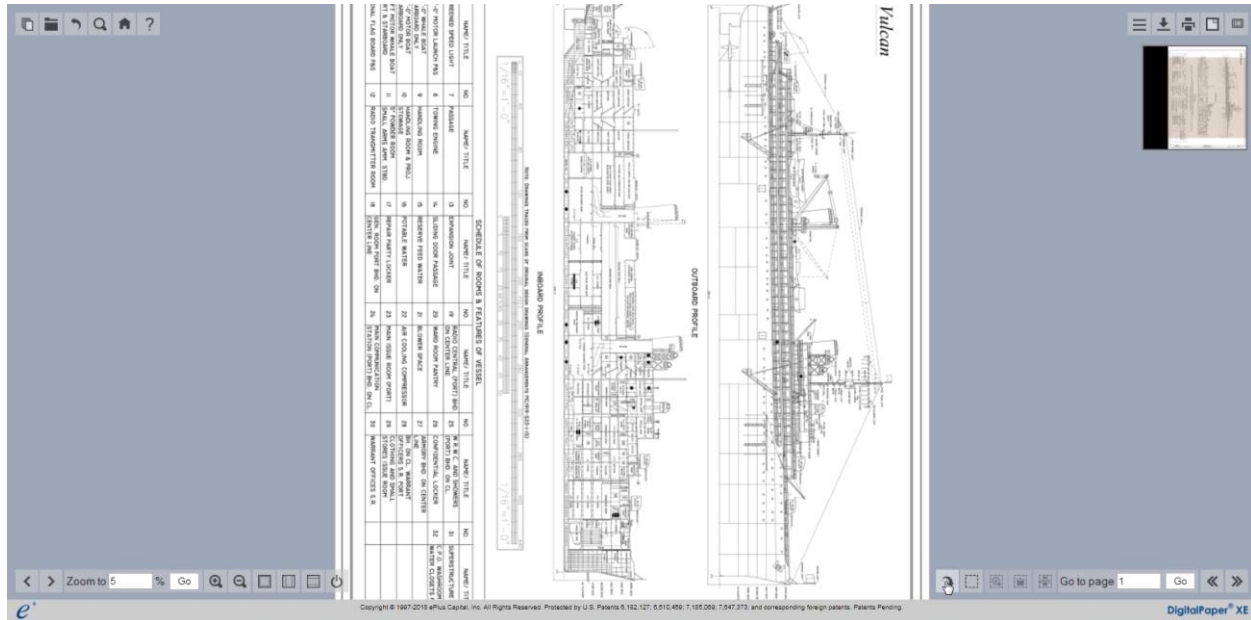

Select a region of the image

Image region selection is used for the Zoom to, Copy, and Print region functions. It is a toggle that turns region selection on and off.

To enable region selection, move the mouse pointer over the control

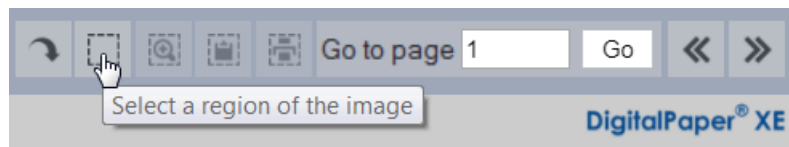

then click. The control will turn red to indicate that region selection is active

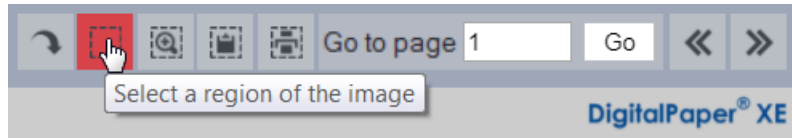

and the mouse pointer will change to a crosshair when inside the viewport.

To select a region, simply move the mouse pointer to any corner of the region of interest then press and hold the left mouse button while dragging the mouse to the opposite corner of the region. When the opposite corner is reached, release the mouse button. The selected area will be highlighted:

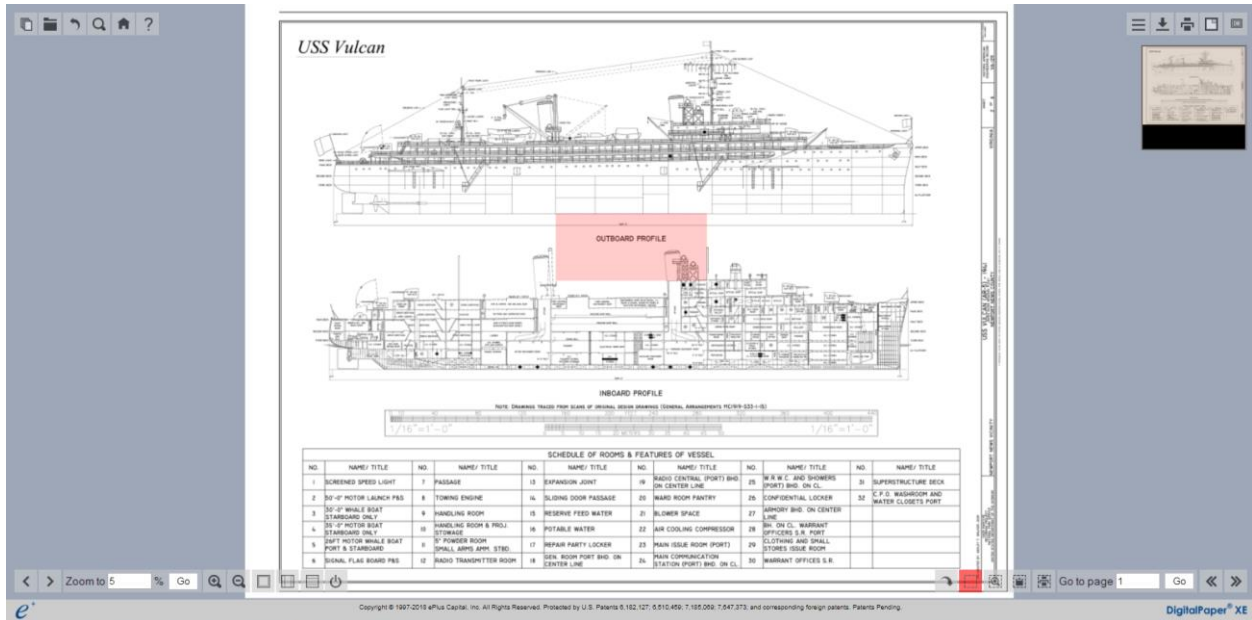

To turn off region selection, simply move the mouse pointer over the control and click. The control will go back to its original state, indicating that region selection has been turned off.

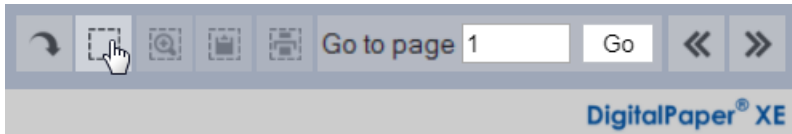

Zoom to the selected region

First select a region as described previously:

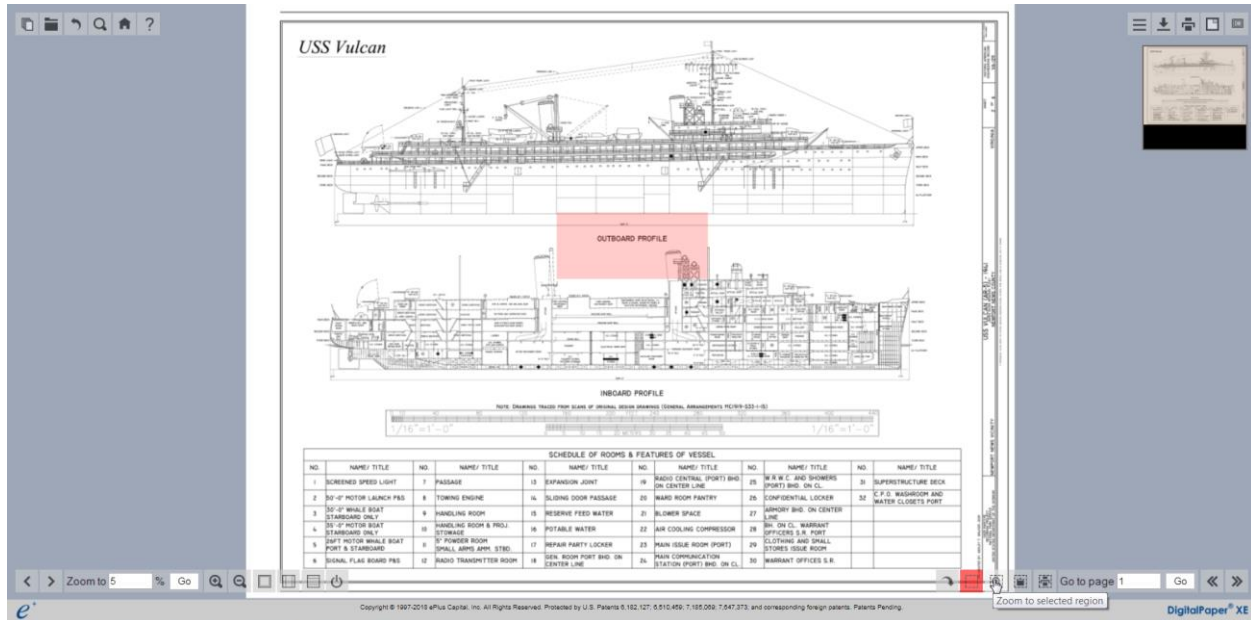

then press the control. The viewport will update to display the zoomed-to area:

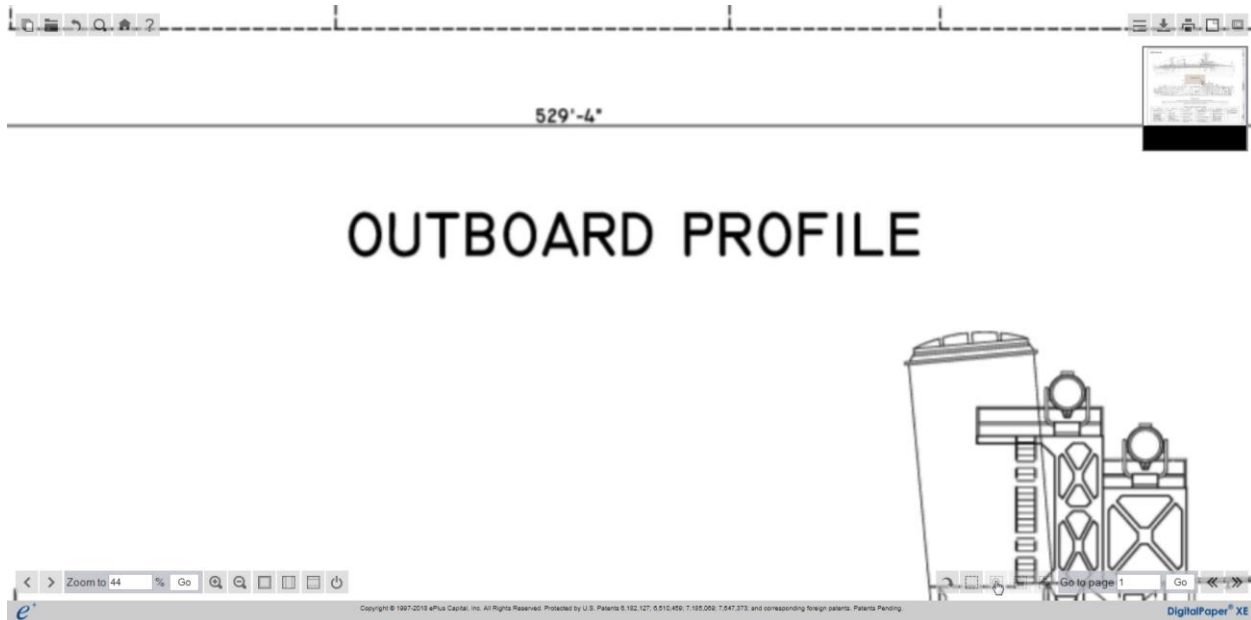

Copy the selected region to the clipboard 

Note: The *DPPrint* helper application must be installed in order for *Copy the selection region to the clipboard* to work. See *About DPrint* in the *Enterprise User's Guide* for more information.

First select a region as described previously:

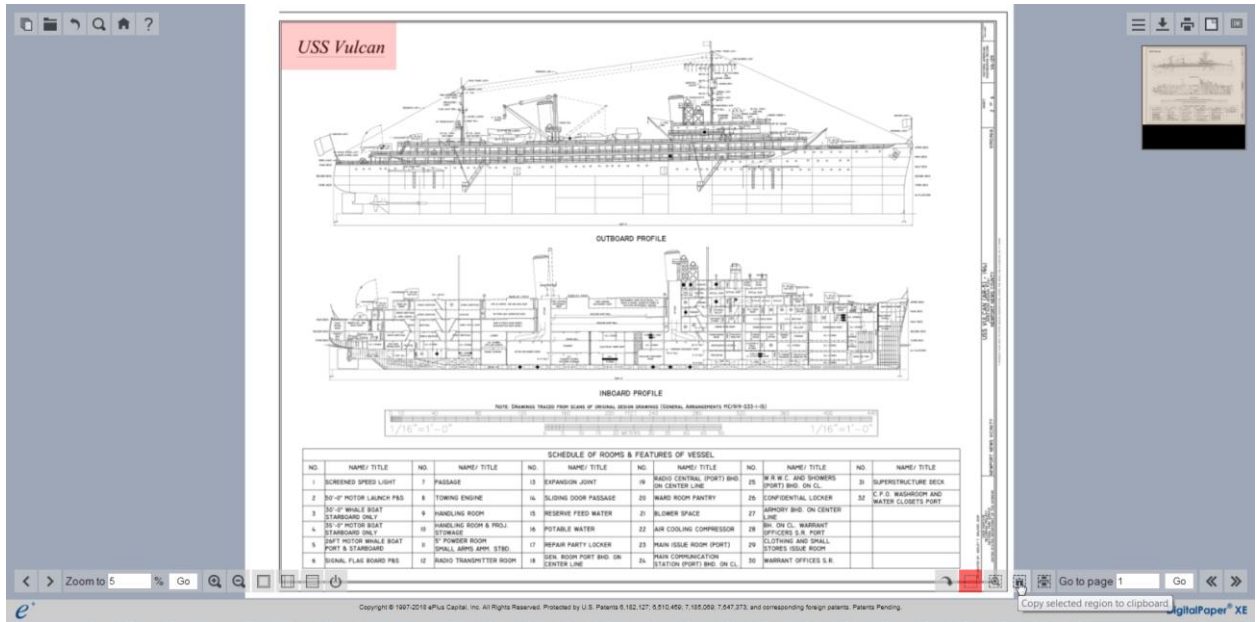

then press the control. DPPRINT will display a popup when the region has been copied to the clipboard:

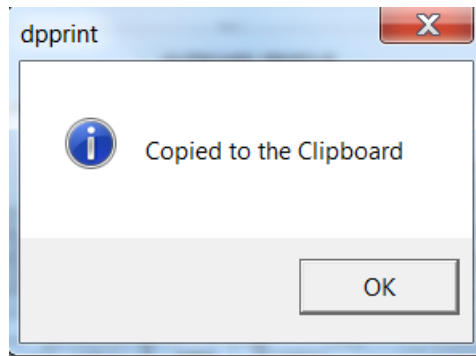

The clipboard contents can then be pasted into an application (e.g. Paint):

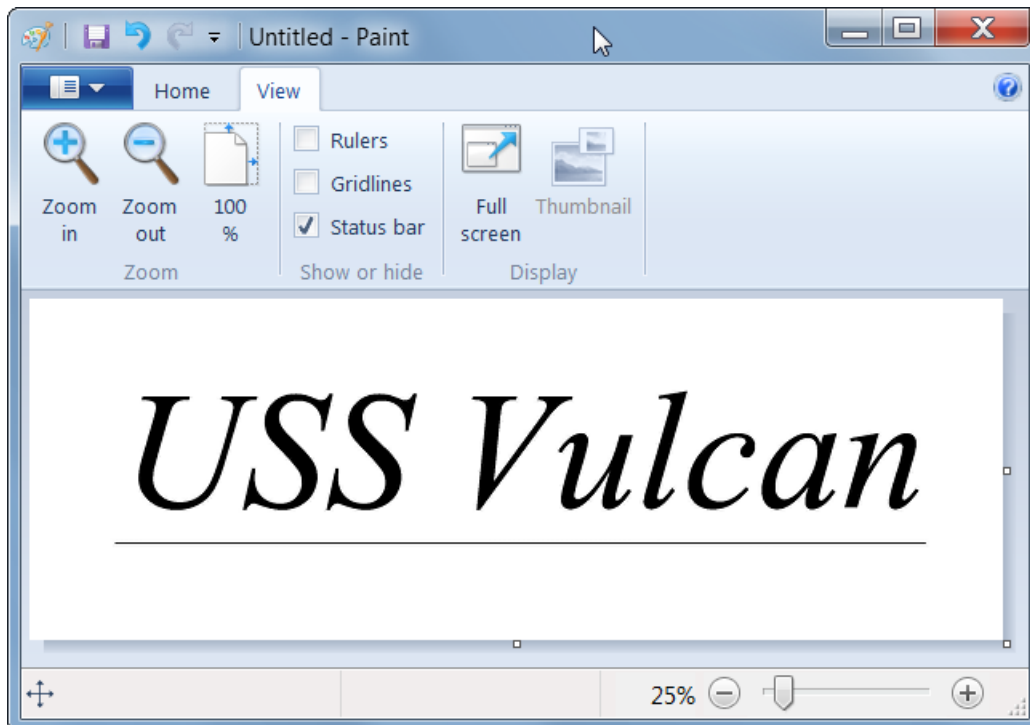

Print the selected region

Note: The *DPPrint* helper application must be installed in order for *Copy the selection region to the clipboard* to work. See *About DPPrint* in the *Enterprise User's Guide* for more information.

First select a region as described previously:

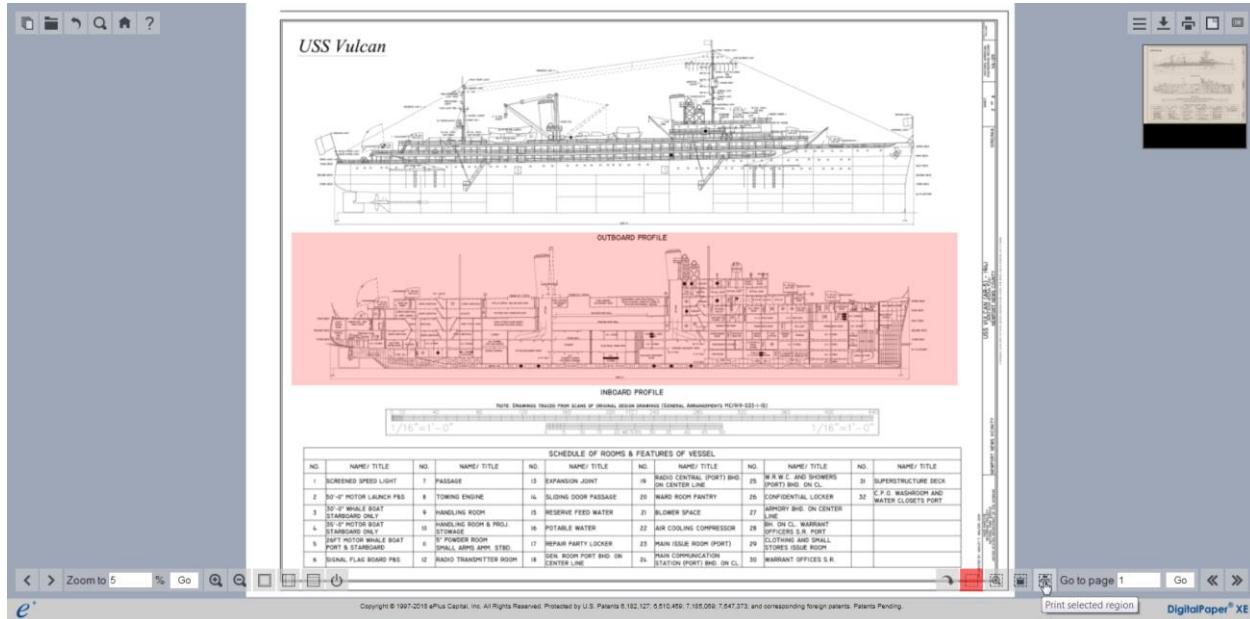

then press the control. DPPRINT will display a popup when the region is ready to print:

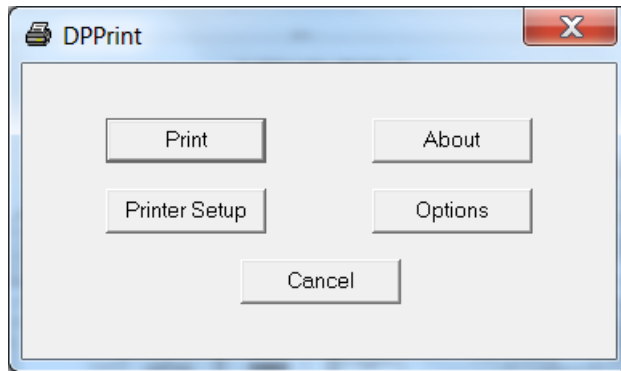

Click Printer Setup to launch the print setup page associated with your local printer, then click the Print button from that page, or simply click Print from the DPPrint dialog to submit the print job.

When the print job has been submitted the following popup will appear:

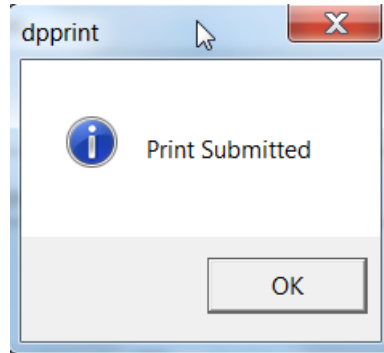

View/Set page to display

The *Go to page* value shows the current page of the image being displayed in the viewport.

To go to a different page, enter the page number then press the *Go* button. The viewport will contain the image of the selected page.

Example: To display page 100 of the current document, enter *100* in the *Go to page* field then move the mouse pointer over the *Go* button:



then press *Go*. Page 100 will be displayed:



ViewMark Controls

Note: ViewMark functionality must be enabled for the ViewMark controls to be displayed. See your system administrator for more information.

ViewMark controls are typically hidden but may be displayed by pressing the *Toggle ViewMark controls* button. To display the controls, move the mouse pointer over the control,

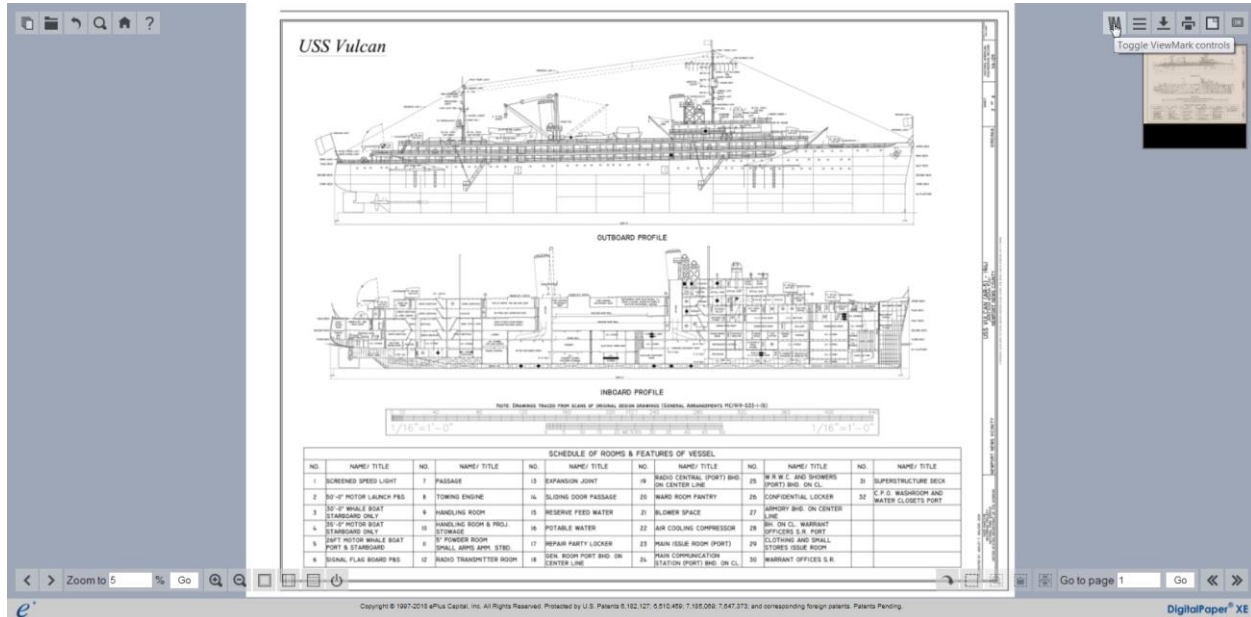

then click. The ViewMark controls will either appear if they are currently invisible or disappear, if they are currently visible:

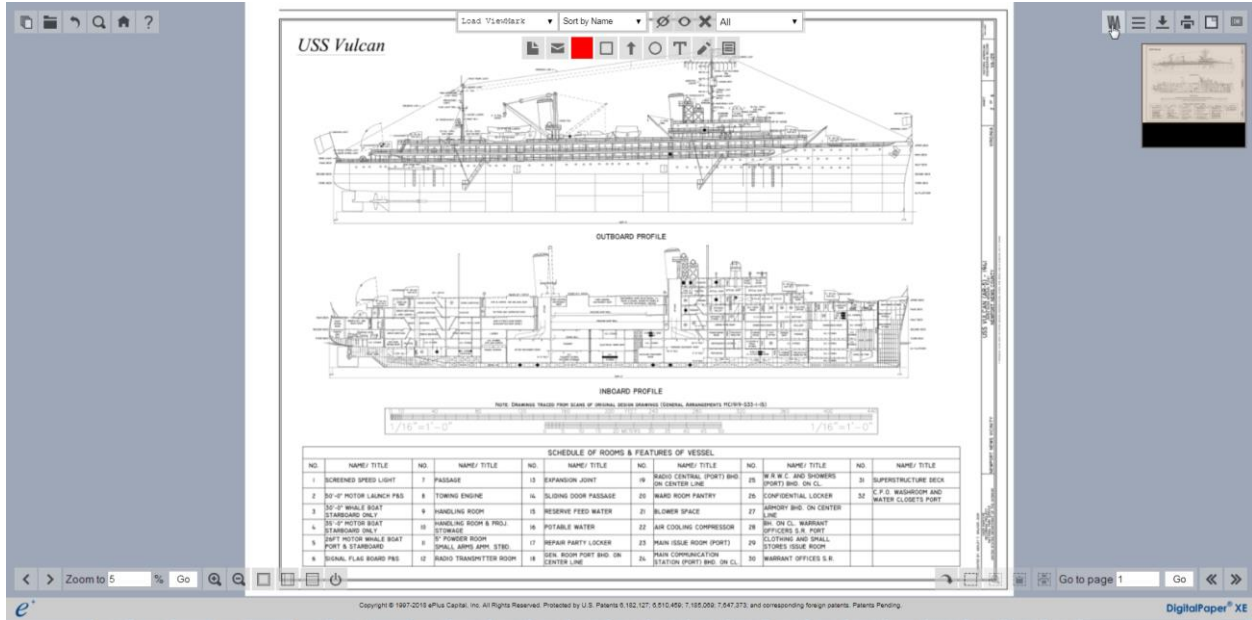

The following table describes each control's function:

ViewMark Controls	
	Save a ViewMark
	Send a ViewMark
	Set the ViewMark color
	Draw a rectangle
	Draw an arrow
	Draw a circle
	Add text
	Highlight an area
	Add a note

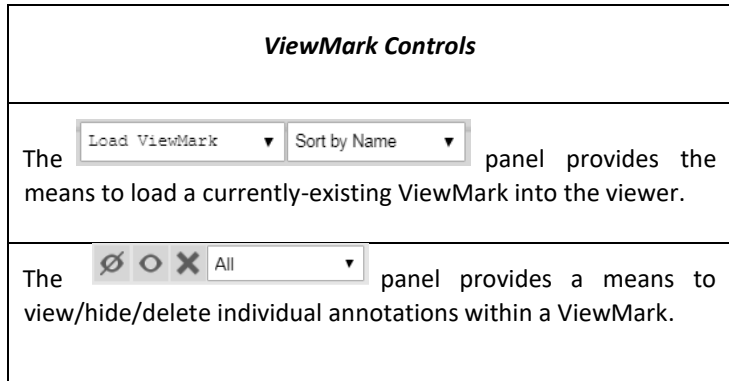

Please see the following section for more information.

Annotate a Document

This section describes how to mark any area of a document with multi-colored ViewMark annotations. A ViewMark annotation may consist of a circle, rectangle, text, arrow, highlighted area or highlighted text note. ViewMark annotations may be hidden or deleted. Adding ViewMark annotations to a drawing does not change the document stored in the repository but is a powerful tool to draw attention to changes or to add comments. The figure below illustrates what a ViewMark looks like.

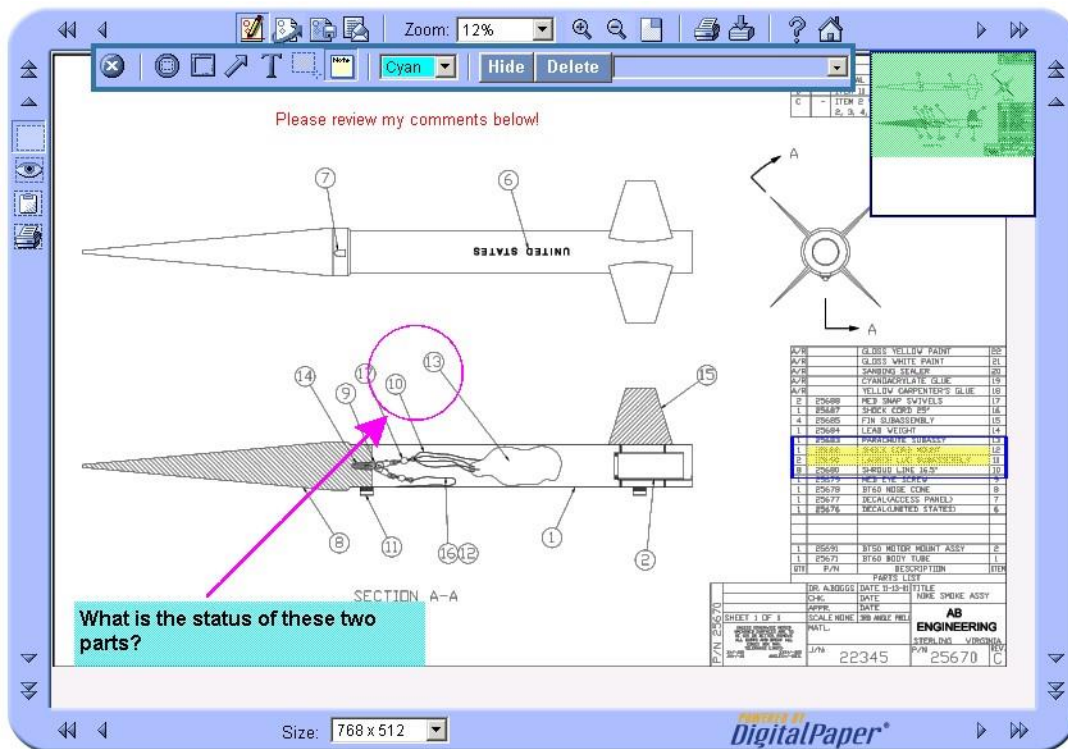

Figure 4.16: Sample ViewMark

A ViewMark—which is treated as a collection of annotations that contain page, scale and region of interest information—can be saved, referenced, and sent to other DigitalPaper XE users that have access to the cabinet in which the document is stored. Please contact the Application Configuration Specialist to determine if the user has this type of access.



The sections that follow describe how to create and save annotations, and send a link to the ViewMark to other DigitalPaper XE users. Before continuing, if the Viewer is not open, open the document you wish to mark up as described in View a Document's Image.

Add a Text Annotation

1. Click the *Create ViewMark* button  in the top left portion of the Viewer frame to display the ViewMark toolbar.



Figure 4.17: ViewMark toolbar

2. Click the *Text* button  in the toolbar.
3. From the color pulldown menu , select a color in which to draw the text.
4. Move your cursor over the area where you wish the text to be placed. Your cursor will turn into a green cross-hair. Click the mouse where you wish the text area to begin, hold the left mouse key down and draw a selection box to encompass the area where the text will appear. When you have drawn the selection box, release the left mouse button. A dialog will appear as shown below.

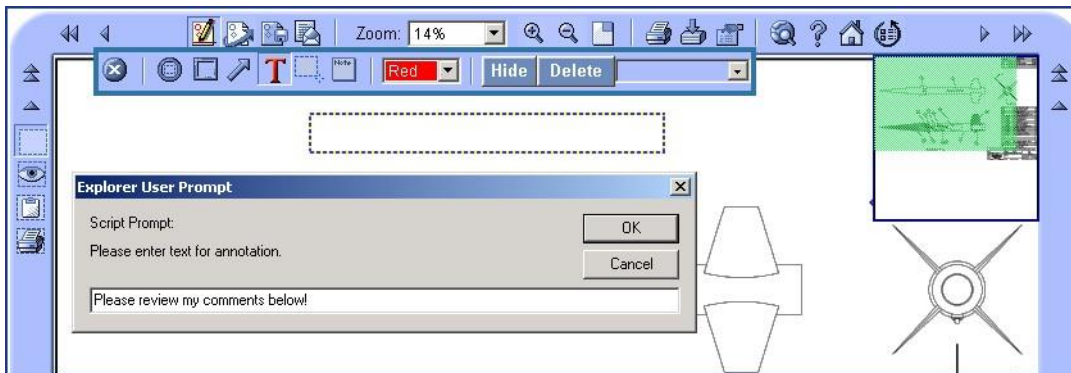

Figure 4.18: Creating a text annotation

5. Enter the text (up to 80 characters) in the dialog then click OK.
6. The text will appear in the selected area using a pre-determined font and size that cannot be modified.





Figure 4.19: Text annotation added

7. Once the text has been added, it cannot be changed (e.g., the text cannot be dragged to a new location, nor its color modified). However, if you are not satisfied with your text entry, use one of the following methods to delete the annotation:
8. Select the text entry from the ViewMark toolbar's pulldown menu, then click the Delete button. For an example, See *Hide and/or Delete ViewMark Annotations*.

9. Click the browser's Back button to remove the most recently added ViewMark annotation (in this example, the text annotation).
10. If you wish to save the current annotation(s) at this point in time, see *Save a ViewMark*. To draw additional annotations, go to any of the following sections:
11. *Add a Circle Annotation.*
12. *Add a Rectangle Annotation.*
13. *Highlight an Area.*
14. *Add an Arrow Annotation.*
15. *Add a Highlighted Note.*

Add a Circle Annotation

1. If it is not already enabled, click the *Create ViewMark* button  on the top of the Viewer to display the ViewMark toolbar.
2. Click the *Circle* button  in the toolbar.
3. From the color pulldown menu , select a color in which to draw the circle.
4. Move your cursor over the area where you wish the circle to be placed. Your cursor will turn into a green cross-hair. Click the mouse where you wish the circle to begin, hold the left mouse key down and draw a selection box to encompass the area where the annotation will appear.

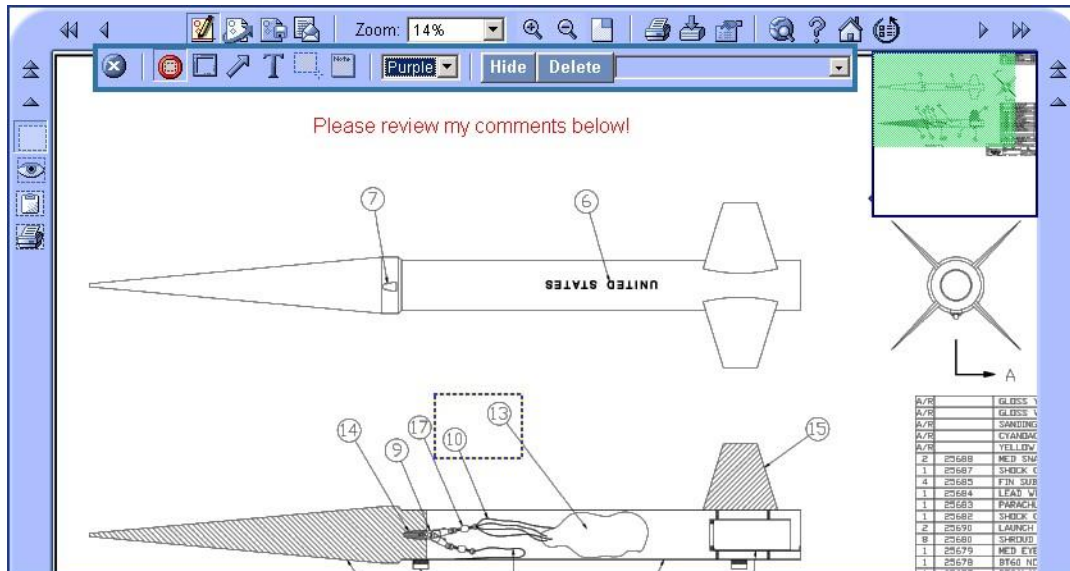

Figure 4.20: Selecting an area to place a circle annotation

5. When you have drawn the selection box, release the left mouse button.
6. The area selected will appear as a circle.

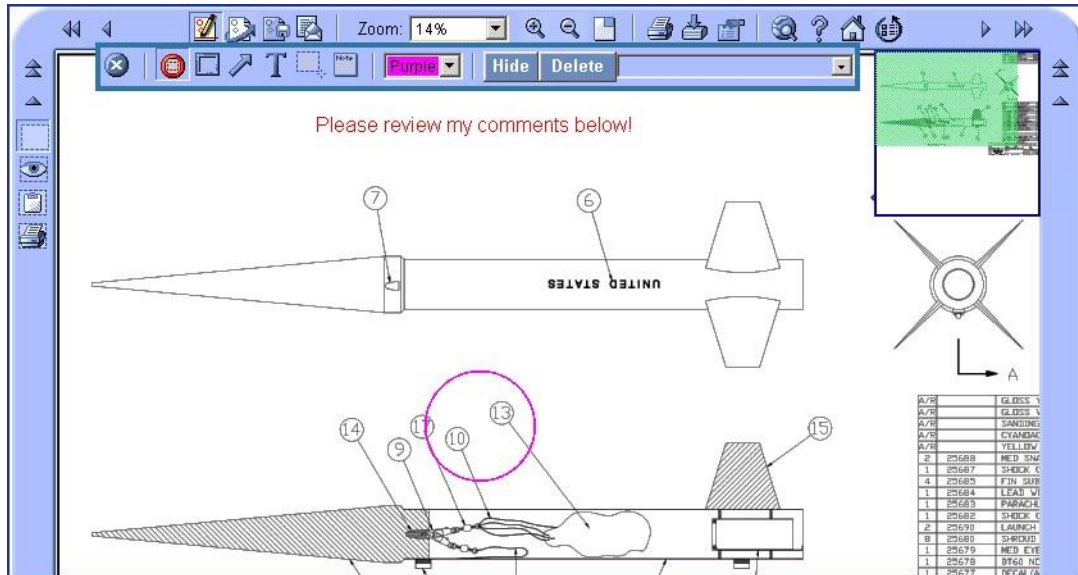
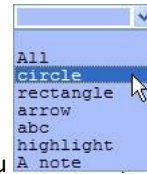
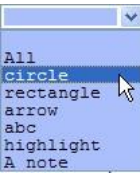





Figure 4.21: Circle annotation added

- Once the circle has been added, it cannot be changed (e.g., the circle cannot be resized, nor its color modified). However, if you are not satisfied with your entry, use one of the following methods to delete the annotation:



- Select the annotation label (e.g., *circle*.) from the ViewMark toolbar's pulldown menu , then click the *Delete* button . For an example, See *Hide and/or Delete ViewMark Annotations*.
- If you wish to save the current annotation(s) at this point in time, see *Save a ViewMark*. To draw additional annotations, go to any of the following sections:
 - Add a Text Annotation*.
 - Add a Rectangle Annotation*.
 - Highlight an Area*.
 - Add an Arrow Annotation*.
 - Add a Highlighted Note*.

Add a Rectangle Annotation

- If it is not already enabled, click the *Create ViewMark* button  on the top of the Viewer to display the ViewMark toolbar.
- Follow the exact same procedure as described in *Add a Circle Annotation*, except click the *Rectangle* button  in the toolbar.
- From the color pulldown menu , select a color in which to draw the rectangle.
- Move your cursor over the area where you wish the rectangle to be placed. Your cursor will turn into a green cross-hair. Click the mouse where you wish the rectangle to begin, hold the left mouse key down and draw a selection box to encompass the area where the rectangle will appear.

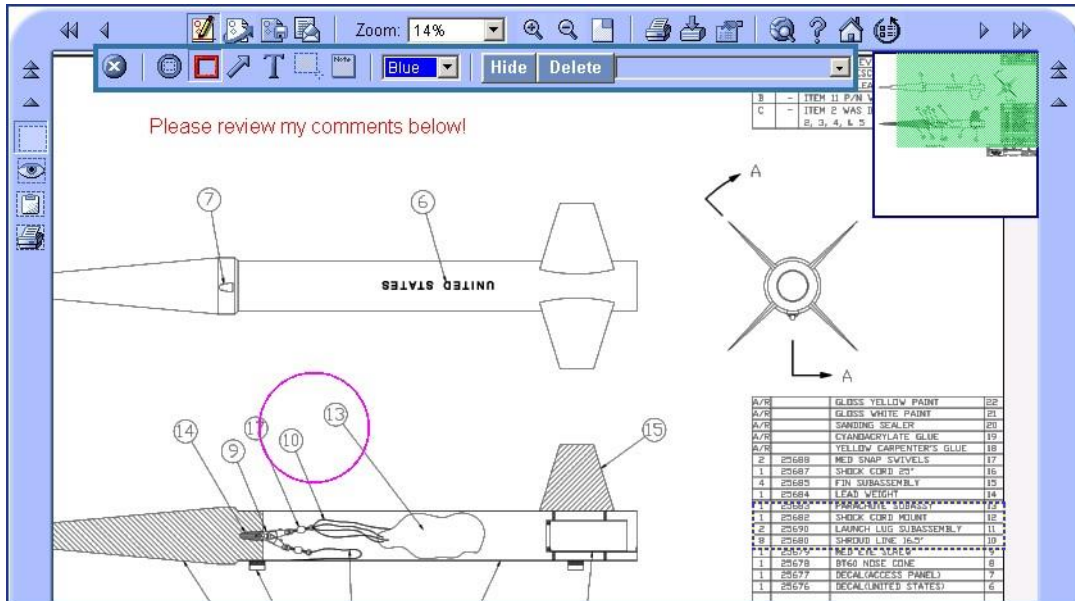

Figure 4.22: Creating a rectangle annotation

5. When you have drawn the selection box, release the left mouse button.
6. The area selected will appear as a rectangle.

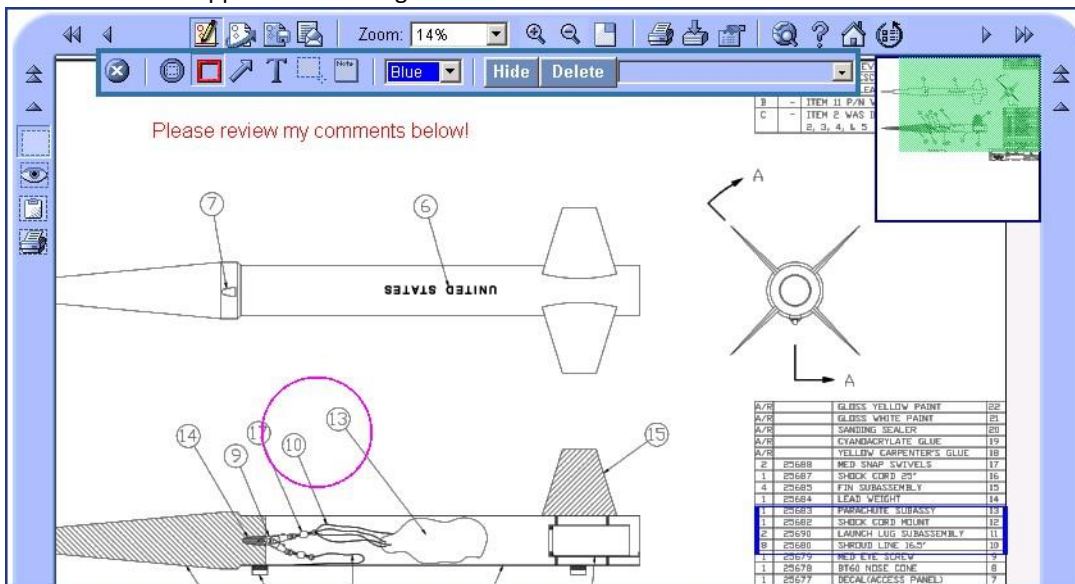





Figure 4.23: Rectangle added

7. Once the rectangle has been added, it cannot be changed (e.g., the rectangle cannot be resized or moved, nor its color modified). However, if you are not satisfied with your entry, use one of the following methods to delete the annotation:
8. Select the ViewMark annotation label (e.g., *rectangle*) from the ViewMark toolbar's pulldown menu, then click the Delete button. For an example, See *Hide and/or Delete ViewMark Annotations*.
9. Click the browser's Back button to remove the most recently added ViewMark annotation (in this example, to remove the circle annotation).

10. If you wish to save the current annotation(s) at this point in time, see Save a ViewMark. To draw additional annotations, go to any of the following sections:
11. *Add a Text Annotation.*
12. *Add a Circle Annotation.*
13. *Highlight an Area.*
14. *Add an Arrow Annotation.*
15. *Add a Highlighted Note.*

Highlight an Area

1. If it is not already enabled, click the Create *ViewMark* button  on the top of the Viewer to display the ViewMark toolbar.
2. Click the Highlight button  in the toolbar.
3. From the color pulldown menu , select a color in which to draw the highlighted area.
4. Move your cursor over the area where you wish the highlighted area to be placed. Your cursor will turn into a green cross-hair. Click the mouse where you wish the highlighted area to begin, hold the left mouse key down and draw a selection box to encompass the area where the highlight will appear.

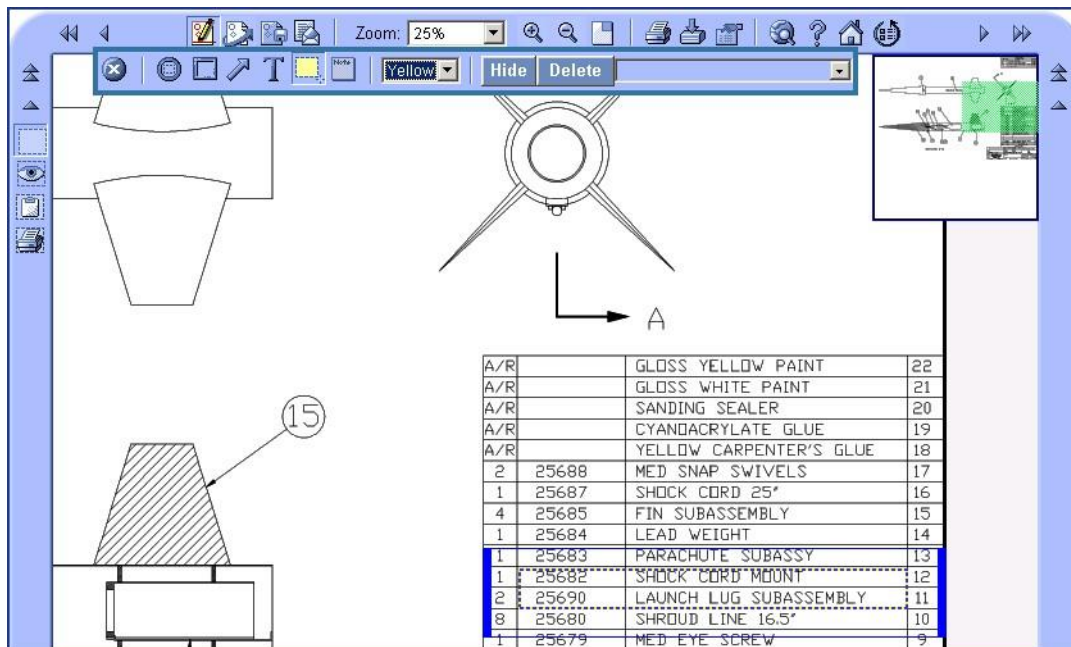

Figure 4.24: Creating a highlight annotation

When you have drawn the selection box, release the left mouse button.

5. The area will be highlighted in the selected color.

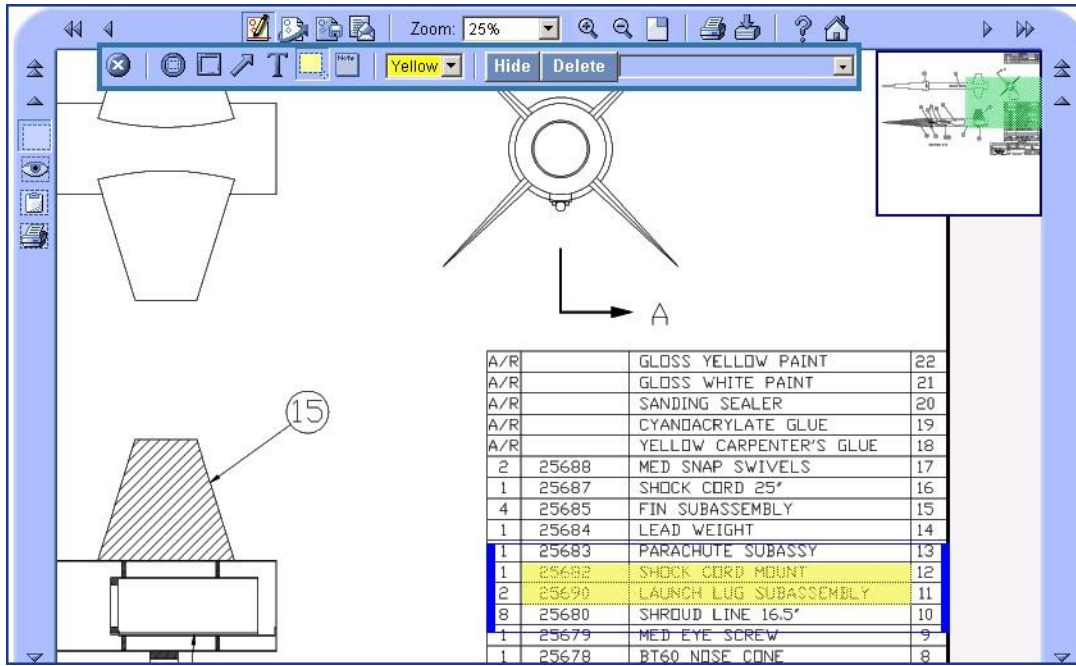





Figure 4.25: Highlight added

6. Once highlight has been added, the highlighted region cannot be changed (e.g., the highlight cannot be made larger or smaller, nor its color modified). However, if you are not satisfied with your highlighted entry, use one of the following methods to delete the annotation:
 7. Select the *highlight* entry from the ViewMark toolbar's pulldown menu, then click the Delete button. For an example, See *Hide and/or Delete ViewMark Annotations*.
 8. Click the browser's Back button to remove the most recently added ViewMark annotation (in this case, to remove the highlight).
 9. If you wish to save the current annotation(s) at this point in time, see *Save a ViewMark*. To draw additional annotations, go to any of the following sections:
 10. *Add a Text Annotation*.
 11. *Add a Circle Annotation*.
 12. *Add a Rectangle Annotation*.
 13. *Add an Arrow Annotation*.
 14. *Add a Highlighted Note*.

Add an Arrow Annotation

1. If it is not already enabled, click the *Create ViewMark* button  on the top of the Viewer to display the ViewMark toolbar.
2. Click the Arrow button  in the toolbar.
3. From the color pulldown menu , select a color in which to draw the arrow.
4. Move your cursor over the area where you wish the arrow to be placed. Your cursor will turn into a green cross-hair. Click the mouse where you wish the tail of the arrow to begin, hold the left mouse key down and draw a selection box

to encompass the area where the arrow will appear. The point where you end your selection box is where the arrowhead will appear. When you have drawn the selection box, release the left mouse button.

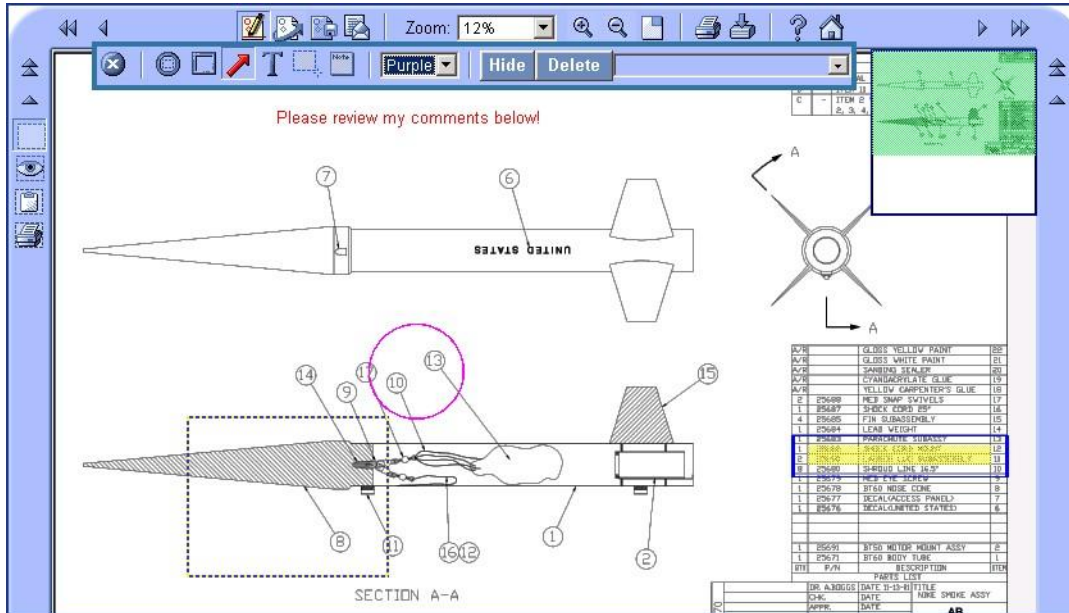

Figure 4.26: Creating an arrow annotation

- The arrow will appear in the selected area using a pre-determined size that cannot be modified.

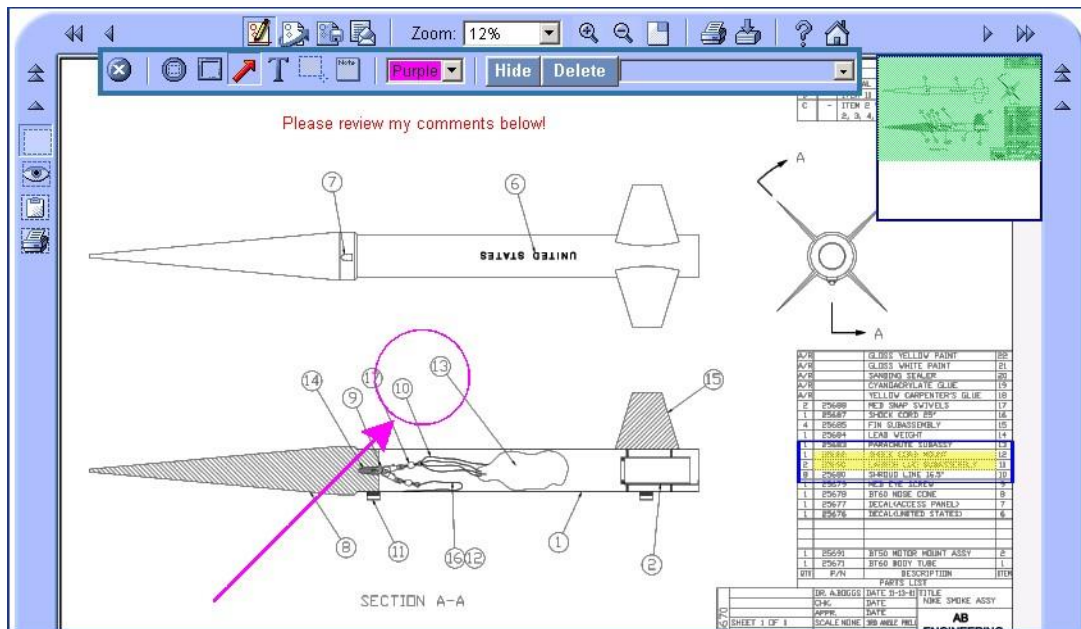



Figure 4.27: Arrow annotation added

- Once the arrow has been added, it cannot be changed (e.g., the arrow cannot be resized or moved, nor its color modified). However, if you are not satisfied with your entry, use one of the following methods to delete the annotation:
 - Select the *arrow* label from the ViewMark toolbar's pulldown menu, then click the Delete button. For an example, See *Hide and/or Delete ViewMark Annotations*.
 - Click the browser's Back button to remove the most recently added ViewMark annotation.

9. If you wish to save the current annotation(s) at this point in time, see Save a ViewMark. To draw additional annotations, go to any of the following sections:
10. *Add a Text Annotation.*
11. *Add a Circle Annotation.*
12. *Add a Rectangle Annotation.*
13. *Highlight an Area.*
14. *Add a Highlighted Note.*

Add a Highlighted Note

If it is not already enabled, click the *Create ViewMark* button  on the top of the Viewer to display the ViewMark toolbar.

1. Click the Note button  in the toolbar.
2. From the color pulldown menu , select a color in which to draw the background of the highlighted note (the text will always appear in black in the foreground).
3. Move your cursor over the area where you wish the text to be placed. Your cursor will turn into a green cross-hair. Click the mouse where you wish the text area to begin, hold the left mouse key down and draw a selection box to encompass the area where the text will appear. When you have drawn the selection box, release the left mouse button. A dialog used to enter the text will appear as shown below.

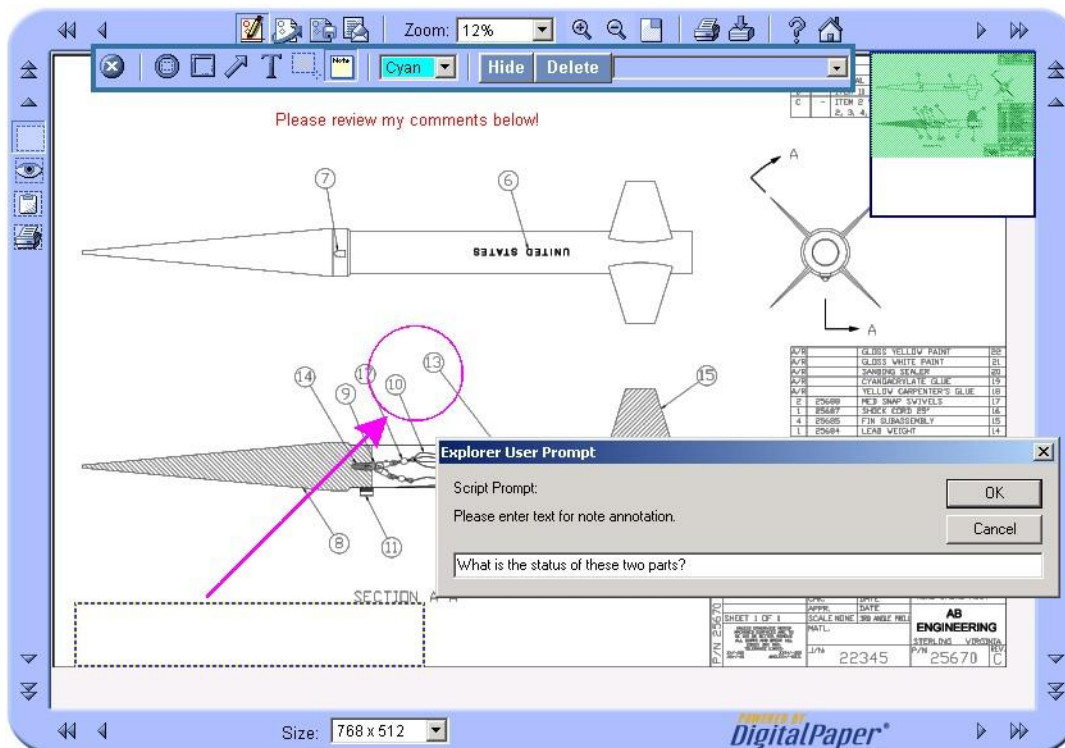

Figure 4.28: Creating a highlighted note annotation

4. Enter the text (up to 80 characters) in the dialog then click OK.
5. The text will appear in the selected area with a highlighted background. The pre-determined font type and font size cannot be modified.

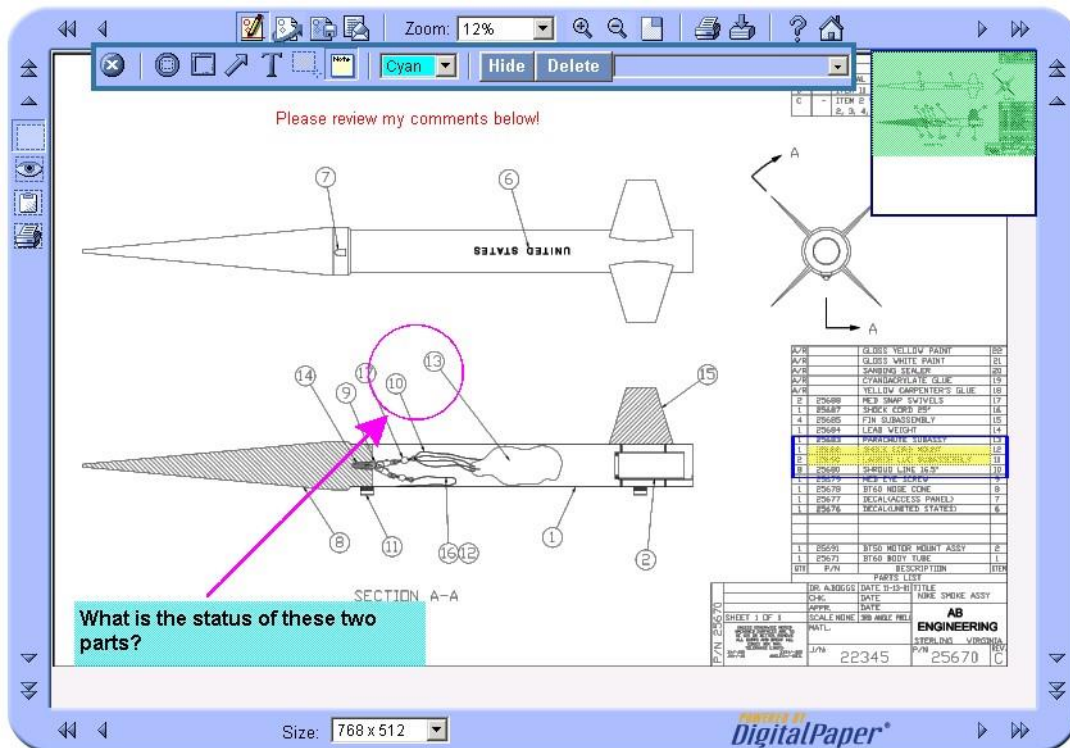

Figure 4.29: Highlighted note annotation added

6. Once the highlighted note annotation has been added, it cannot be changed (e.g., the text cannot be modified, nor the color of the highlight changed). However, if you are not satisfied with your highlighted note, use one of the following methods to delete the annotation:
 7. Select the highlighted note entry from the ViewMark toolbar's pulldown menu, then click the Delete button. For an example, See *Hide and/or Delete ViewMark Annotations*.
 8. Click the browser's Back button to remove the most recently added ViewMark annotation.
 9. If you wish to save the current annotation(s) at this point in time, see *Save a ViewMark*. To draw additional annotations, go to any of the following sections:
 10. *Add a Text Annotation*.
 11. *Add a Circle Annotation*.
 12. *Add a Rectangle Annotation*.
 13. *Highlight an Area*.
 14. *Add an Arrow Annotation*.
 15. *Add a Highlighted Note*.

Hide and/or Delete ViewMark Annotations

You can selectively hide existing ViewMark annotations or delete them by choosing a ViewMark annotation from the ViewMark pulldown menu and selecting the hide or delete button from the toolbar. You can also re-display a hidden ViewMark annotation as described below.

1. Select an entry from the pulldown menu on the ViewMark toolbar as shown in the figure below. Select the ALL entry to select all ViewMark annotations.

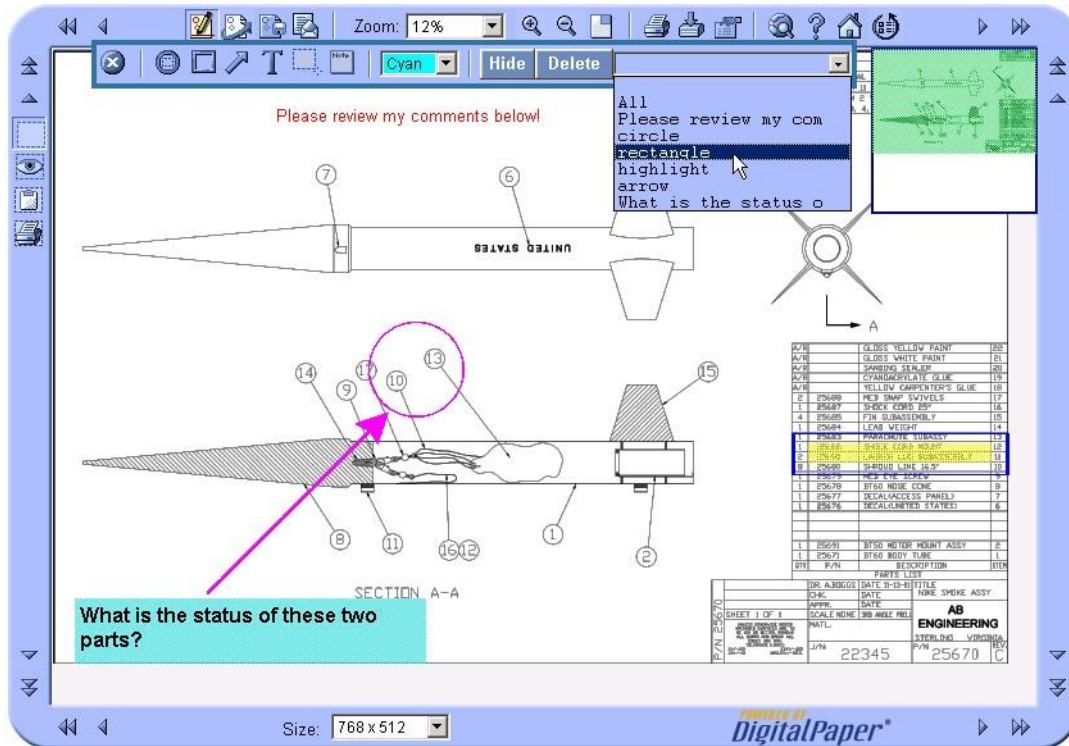

Figure 4.30: Select annotation(s) to hide or delete

2. Select the Hide button **Hide** to remove the selected annotation(s) from the image. Click the Show button **Show** to redisplay the hidden annotation.
3. Select the Delete button **Delete** to permanently remove the annotation(s). When the Delete button is clicked, you will be prompted to remove the annotation. Click OK to permanently remove the ViewMark annotation, or Cancel to keep the ViewMark annotation.
4. If you wish to send these ViewMarks to another user without saving them, leave the Viewer window open then Go to *Send a ViewMark to Another User*. Otherwise, proceed to Save a ViewMark.

Save a ViewMark

You can choose to save one or more annotations overlaid on the document as a ViewMark so it can be referenced at any time when users view a document's image or its properties. At no time is the original document altered as each ViewMark is stored separately from the source document.

Note

Your ability to save ViewMarks may be restricted by the Application Configuration Specialist. In addition, the saved ViewMark will not be stored with the document when added to a DocPak (for security purposes).

Save a New ViewMark

To save a ViewMark for a document that has no pre-existing ViewMarks, follow the steps below. If you are saving a ViewMark for a document that already has pre-existing ViewMarks, please See *Update a Document with Previously Saved ViewMarks*.

After adding ViewMark annotations to a document, click the *Save ViewMark* button .

1. The Save ViewMark dialog appears.

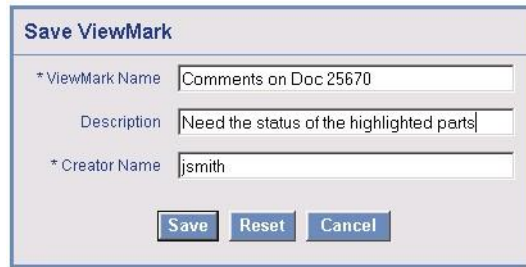

The image shows a 'Save ViewMark' dialog box with the following fields and buttons:

- * ViewMark Name:** Comments on Doc 25670
- Description:** Need the status of the highlighted parts
- * Creator Name:** jsmith
- Buttons:** Save, Reset, Cancel

Figure 4.31: Save ViewMark dialog

2. In the *ViewMark* Name field, enter a unique name (up to 80 characters) for the ViewMark.
3. In the Description field, enter text describing the ViewMark (up to 512 characters).
4. If you are not required to log in to the system, enter your name (up to 80 characters) in the Creator Name field as the author of the ViewMark. If you supplied a username when you logged into the system, the name appears as read-only and cannot be modified.
5. Click the Save button.
6. The ViewMark is now associated with the document and can be referenced at any time by users who have access to the document. If you wish to send your saved ViewMark to another user, leave the Viewer open with the selected ViewMark displayed, then go to *Send a ViewMark to Another User*.

Send a ViewMark to Another User

A ViewMark is most useful when used to communicate changes to other DigitalPaper XE users. You can provide other DigitalPaper XE users with access to ViewMarks using an e-mail program configured with an Internet browser.

When sending an e-mail from DigitalPaper XE, the actual document is not attached to the message so file size is not an issue. Only a link representing the document view is sent to the recipient in the form of a special ViewMark URL. As long as the recipient can connect to the DigitalPaper XE server and supply a username and password (if needed), and has been granted access (by the Administrator) to the cabinet containing the document sent, the recipient can view the documents and its ViewMarks.

To send ViewMarks via e-mail:

With the ViewMark displayed in the Viewer, click the *Send ViewMark* icon located on the Viewer toolbar. 

Note

If the document being sent contains one or more ViewMarks that are not currently displayed, the recipient must load them using the Load ViewMark button described later in this chapter.

1. An e-mail window appears with the Subject header and text area filled with the ViewMark URL. Enter the recipients e-mail address and any other text you would like to add in the body of the e-mail.

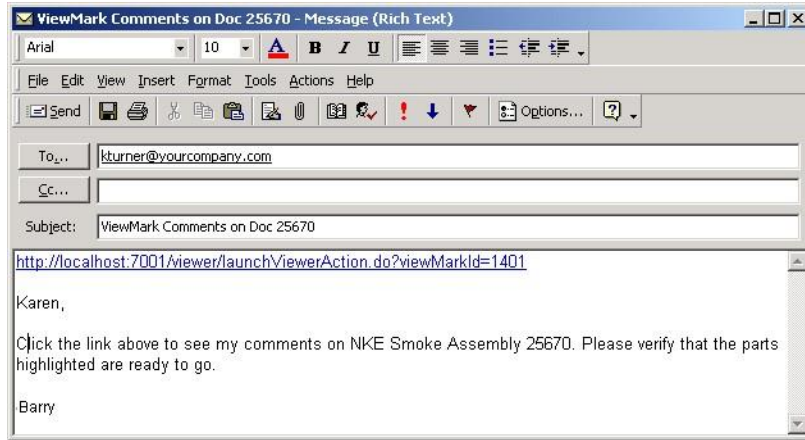

Figure 4.32: E-mail ViewMark

2. Click the e-mail application's Send button.
3. Upon receipt of the e-mail message, the recipient clicks the URL hyperlink within the message to access the document from the XE Server and display it in a web browser. If security is enabled for the group that the recipient is associated with in the system, the recipient must enter his or her user name and password in the User Login page to access the document.
4. The document is displayed to the recipient in the Viewer in the same condition as you sent it (including Bird's Eye View and ViewMark toolbar settings).

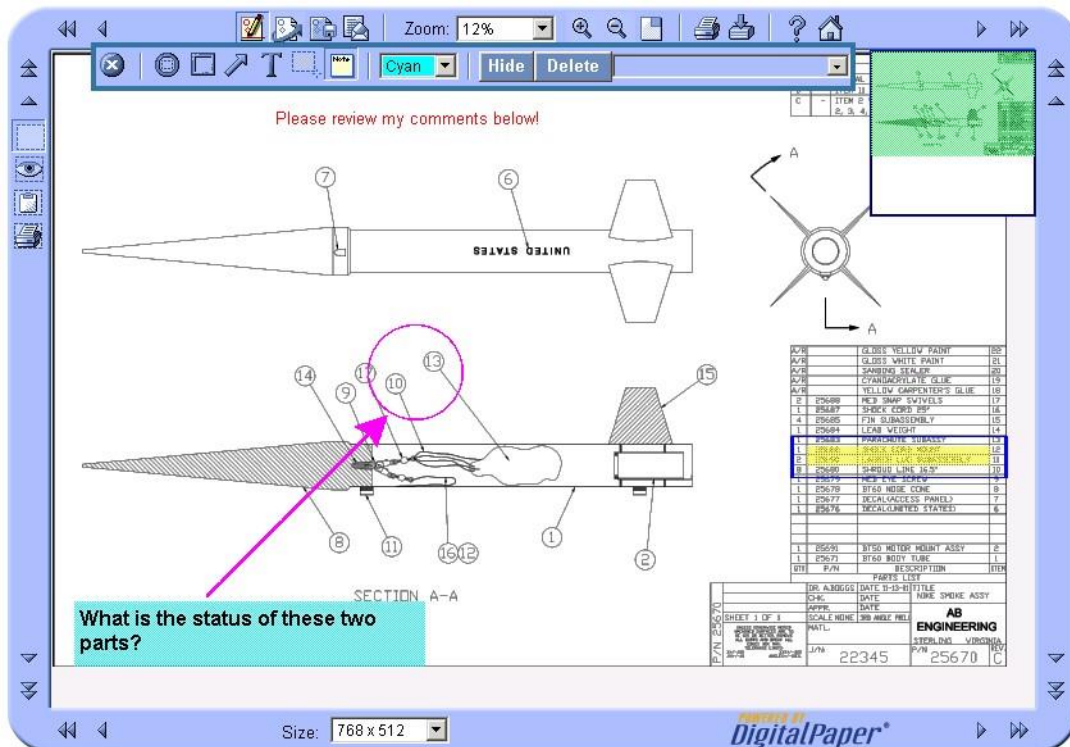



Figure 4.33: Document with saved ViewMark received

Note

If a ViewMark annotation was hidden when sent, e-mail recipients will be able to see the annotation using the ViewMark toolbar's Show button.

- ViewMark recipients can add their own ViewMark annotations to the document they received (or create a ViewMark for a different document) using the same methods described in *Annotate a Document* and then send you the ViewMark.

For more information on receiving a ViewMark, See *Receive a ViewMark*.

- Click the *Close Viewer* button to return to the page you were previously viewing. 

Receive a ViewMark

When you are sent a marked up document, you will receive an e-mail with a link to the ViewMark in the body of the message. Do the following:

- Open the e-mail, then click the link to the ViewMark.
- If not logged in, enter your username and password.
- The document is displayed in the Viewer with the sender's ViewMark annotations.
- To view previously saved ViewMarks, Go to *Load a ViewMark*.
- To add a new ViewMark to a document that already has ViewMarks saved and one of the ViewMarks is displayed, go to *Update a Document with Previously Saved ViewMarks*.

Load a ViewMark

To display a list of all ViewMarks that have been saved with the document (e.g., to gain context for the current ViewMark), click the *Load ViewMark* button. 

- The Load ViewMark menu appears. Click the down arrow button next to the Load ViewMark menu to display the information saved with each saved ViewMark, as well as the date each ViewMark was saved.

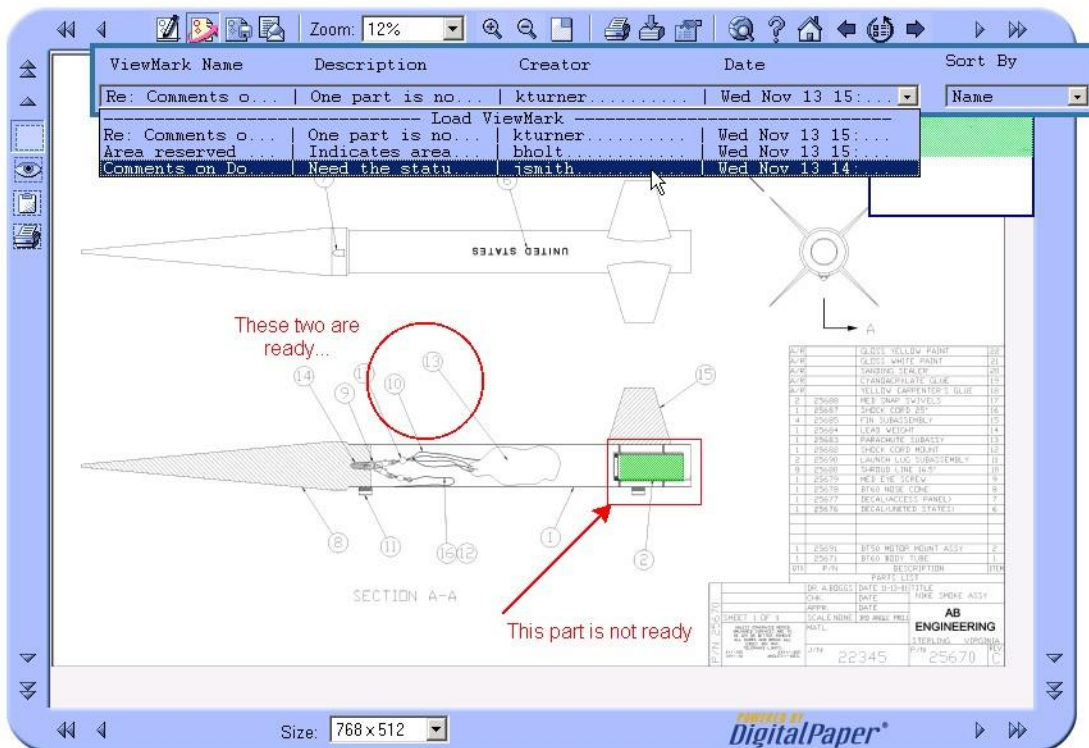



Figure 4.34: Load ViewMark menu



2. (Optional) Select how you wish the ViewMarks stored with this document to be displayed in the pulldown menu by selecting Name, Description, Creator, or Date from the Sort By pulldown menu.
3. Select the ViewMark of interest from the pulldown menu to display it in the Viewer.
4. When done, close the Load ViewMark menu by clicking the *Load ViewMark* button again. 
5. If desired, you can continue the collaboration process by adding a new ViewMark to the document, then sending it back to the ViewMark sender. For more information, See *Update a Document with Previously Saved ViewMarks*.

Update a Document with Previously Saved ViewMarks

You can update a document that already has saved ViewMark displayed by deleting an existing annotation in the ViewMark (regardless of the ViewMark author), adding a new annotation, and saving your changes as a new ViewMark.

To annotate a document that has previously saved ViewMark annotations:

If the ViewMark you wish to annotate is not displayed, click the *Load ViewMark* button and follow the instructions in Load a ViewMark. If the document with saved ViewMarks is displayed in the Viewer, you may skip this step.

1. Click the *Create ViewMark* button to create new ViewMark annotations, hide annotations, or delete annotations as described in *Annotate a Document*. 
2. To save your changes, click the *Save ViewMark* button. 

The Save ViewMark page appears with the same information entered the first time the ViewMark was saved.



Figure 4.35: Save ViewMark

3. In the ViewMark Name field, you can either keep the same name or enter a unique name (up to 80 characters) for the new ViewMark.
4. In the Description field, either keep the current text or enter new text describing the new ViewMark (up to 512 characters).
5. If you are not required to log in to the system, you can enter or modify your Creator Name (up to 80 characters). If you supplied a username when you logged into the system, the name appears as read-only and cannot be modified.
6. Select one of the following Save Options:
 - (a) Select *Create Related ViewMark* to create a new saved ViewMark but relate it to the original saved ViewMark (e.g., in the case where the new ViewMark is in direct response to an original ViewMark that was sent). A related ViewMark will be affiliated with the selected ViewMark as described in Obtain a ViewMark History.
 - (b) Select *Create Top-Level ViewMark* to create a new ViewMark combining the original ViewMark with the new changes. This function is similar to "Save As" functionality where the new ViewMark does not need the context afforded by creating a related ViewMark.

Note

The Save Options described above will not be available if you selected *Hide all annotations* from the Load ViewMark menu. In this situation, you will use the dialog described in *Save a New ViewMark* to save the ViewMark.

7. Click the Save button to return to the Viewer with the ViewMark changes displayed.
8. To e-mail the new ViewMark to another user, see the instructions in *Send a ViewMark to Another User*.

Print a ViewMark

Printing a document with one or more ViewMarks works the same way as printing an entire document from any interface with one exception—you can select which ViewMark you wish to print. For more information, please See *Printing a Document*.

What's Next?

If you are finished with the Viewer and creating ViewMarks, click the *Close Viewer* button. Proceed to See *View Document Properties*.

View Document Properties

In addition to viewing an image of the document as described in the previous sections of this chapter, you can also view all the properties associated with the document including its attributes, file properties, revision history and saved ViewMarks (if any). You can choose to view a document's properties from any of the following pages: Document Search Results page, Viewer, or DocPak .

1. To view the document's properties, click the Properties button or link next to the document of interest. 

The Document Properties page appears.







Revision:	C
Doc Name:	NKE Smoke Assembly
Doc No (P/N):	25670
Model:	NKE Smoke
Type:	Manufacturing
Related Site:	www.nkesmoke.com
Sheet:	1
ECN Pending:	No
Review Date:	07/10/2003
File Name:	25670_NKESmokeAssembly.PLT
File Size:	60,320 bytes
MIME Type:	image/tiff
Page Count:	1
Imported:	05/12/2003
Modified:	05/12/2003
Released:	05/12/2003

Figure 4.36: Document Properties page

The Document Properties page contains the document's complete set of attributes, plus file information such as file name, file size, MIME type, page count, when it was created, the last time it was modified, and when it was released to the repository. You can also view the document, print or download the document, view its revision history, and view saved ViewMarks (if any).

For more information on the options available from this page (and the pages that follow), go to the following:

- To display the document in the Viewer, click the View icon or link. For more information, See *View a Document's Image*. If you wish to annotate this document, See *Annotate a Document*.
- Click the Print icon or link to display the Print Options page as described in *Printing a Document*.

- To download the document, click the Download icon or link. For more information, See *Download a Document*.

- To view a document's revision history, click the Revisions icon or link. For more information, See *View a Document's Revision History*.

- To view a document's ViewMark history, click the *ViewMarks* button or link. For more information, See *Obtain a ViewMark History* on the following page. 

View a Document's Revision History

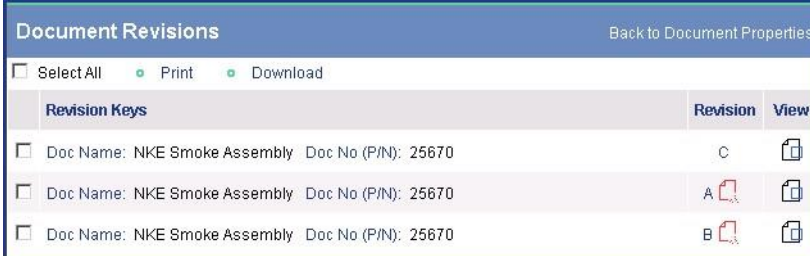
To view a document's revision history from the Document Properties page:

Click the Revisions icon. 

1. The Document Revisions page appears.







Document Revisions		Back to Document Properties	
<input type="checkbox"/> Select All	<input type="radio"/> Print	<input type="radio"/> Download	
Revision Keys	Revision	View	
<input type="checkbox"/> Doc Name: NKE Smoke Assembly Doc No (P/N): 25670	C		
<input type="checkbox"/> Doc Name: NKE Smoke Assembly Doc No (P/N): 25670	A 		
<input type="checkbox"/> Doc Name: NKE Smoke Assembly Doc No (P/N): 25670	B 		

Figure 4.37: Document Revisions page

This page provides a list of all versions of the document that have been imported into the system, including the attributes assigned as revision keys (these are the values required by the system's revisioning scheme to determine the uniqueness of each version of the document), and the revision number or character assigned to the document (old versions are marked with a red symbol that appears next to the revision).

2. If you wish to print, download, or view the document from this page, do the following:
 - To print the document, either mark the *Select All* checkbox or the individual document's checkbox, then click the Print link. For more information, See *Printing a Document*.
 - To download the document, either mark the *Select All* checkbox or the individual document's checkbox, then click the Download link. For more information, See *Download a Document*.
 - To display the document in the Viewer, click the View icon. For more information, See *View a Document's Image*. If you wish to annotate this document, See *Annotate a Document*.
3. To return to the Document Properties page, click the Back to Document Properties link.

Obtain a ViewMark History

In addition to accessing saved ViewMarks from the Viewer, you can obtain a ViewMark history from the Document Properties page.

To obtain a document's ViewMark history:

1. Click the *ViewMarks* button or link.

The ViewMarks page appears.

Viewmarks		Back to Document Properties	
Name	Description	Creator	Date
▼ Area reserved for guidance system	Indicates area to use for guidance system in RFP 4417-B	bholt	7/03/2003
▶ Comments on Doc 25670	Need the status of the highlighted parts	jsmith	7/07/2003

Figure 4.38: Saved ViewMarks page

ViewMarks are displayed by name, description, creator, and date created.

Note

ViewMarks are sorted by name.

- If a ViewMark has related ViewMarks (specified in the Save ViewMark dialog described in *Update a Document with Previously Saved ViewMarks*), it will have a right arrow pointing to it. Click the arrow sign to expand the lists of related ViewMarks.

Viewmarks		Back to Document Properties	
Name	Description	Creator	Date
▼ Area reserved for guidance system	Indicates area to use for guidance system in RFP 4417-B	bholt	7/03/2003
▼ Comments on Doc 25670	Need the status of the highlighted parts	jsmith	7/07/2003
▶ Re: Comments on Doc 25670	One part is not ready	ktuner	7/07/2003
▶ Re: part not ready	Please notify me immediately when this part is ready	jsmith	7/08/2003

Figure 4.39: Related ViewMarks displayed

- To display the ViewMark in the Viewer, click its name in the ViewMarks page. The Viewer will open displaying the document with the selected ViewMark.

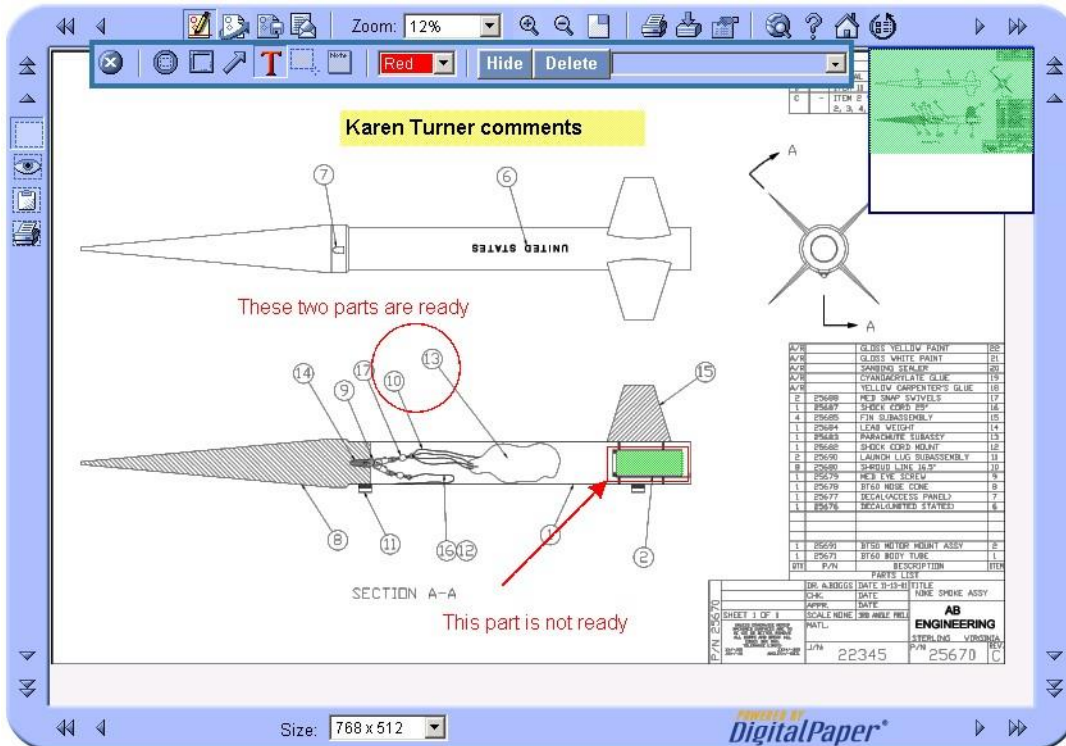

Figure 4.40: Selected ViewMark displayed

4. When finished, click the Close Viewer button to return to the *ViewMarks* page.
5. To return to the Document Properties page, click the Back to Document Properties link.

Printing a Document

Documents can be printed from multiple locations including the Document Search Results page, Viewer, Document Properties page, any page launched from the Document Properties page, or from within DocPaks.

To print a document do the following:

1. Click the Print button or link from any of the pages listed above.

The Printer Options page appears.

The screenshot shows a web browser window titled "DigitalPaper XE@ - Microsoft Internet Explorer". The main content area is titled "Printer Options" and contains several sections with form fields and dropdown menus:

- Printer Options:** Select Printer: Xerox 265-ST
- Number of Copies:** Number: 1
- Print Job Description:** Description: (empty text box)
- Scaling Mode:** Scaling Mode: Fit To Page
- Image Rotation:** Degrees To Rotate: No Rotation
- Tiling:** Multiple Page Printing: Print One Page Only
- Color Printing:** Color/BW Selection: Use All Available Colors
- Print Job Accounting:** Account Name: (empty text box)

Below the "Printer Options" section is the "Viewmark Options" section:

- Select Viewmark to Print: Please review my comments!
- Select Viewmark Options: Do not print a viewmark

At the bottom of the form are two buttons: "Print" and "Cancel".

Figure 4.41: Printer Options page

2. Select a printer from the Select Printer pulldown menu.

Note

The list of available printers is defined by the DigitalPaper XE Application Configuration Specialist.

3. If printing a multi-page document, you have the option to enter the individual pages you would like to print, separated by a comma (e.g., 1, 3, 5) or a print range separated by a dash (e.g., 2-4).
4. The remaining options (e.g., collate, scale, copies) on this page will vary according to the type of printer you selected. .
5. If the document contains saved ViewMarks, select whether or not you wish to print any saved ViewMarks contained within the document. You can select one or more saved ViewMarks to print. When printing a single ViewMark, the entire document associated with the selected ViewMark is printed. If the document is multipage, printing of ViewMark annotations will only print the page containing the ViewMark annotations.

Note

You will not be provided with the option to print a ViewMark if you have selected multiple documents to print.

6. Complete the form then click the Print button to send the document to the printer.

Note

If you are a first time user, you may have to install the DP Print Helper Application before you can continue. For more information, see the *About DPPrint* section of the *Enterprise User's Guide*. If you have already downloaded this application, go to the next step.

A Print Status page will appear as shown below.



Figure 4.42: Print Status

7. Click the Close button.
8. If the print job is not proceeding as expected, you can check the print job status as described in the section below.

Check Print Job Status

If you need to check the status of a print job sent to an enabled Digital Paper Print Server, do the following:

1. Click the Options link in the navigation bar.

The User Options page appears.

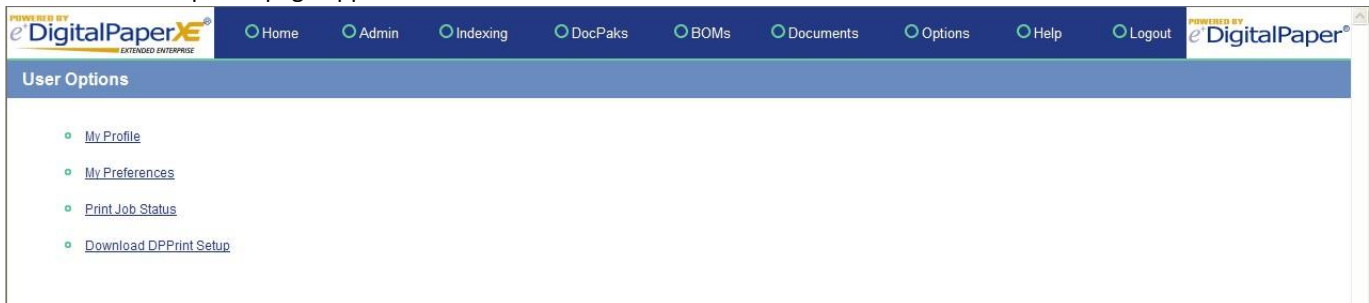

Figure 4.43: User Options page

2. Click the Print Job Status link in the User Options page.

The Print Job Status page appears.

Print Job Status					
Xerox 265ST					Refresh
<input type="checkbox"/> Select All <input type="radio"/> Cancel					
Job ID	Description	User Name	Submitted	Status	
<input type="checkbox"/> 118	Rocket Assembly print job	bholt	24.10.2003 08:12:12	PRINTING	
<input type="checkbox"/> 110	Print Job Description	bholt	23.10.2003 10:46:03	SPOOLING	
<input type="checkbox"/> 115	Printing RFP	bholt	23.10.2003 10:30:56	PRINTING	
<input type="checkbox"/> 109	Test print	bholt	23.10.2003 09:46:00	ERROR	
<input type="checkbox"/> 102	Checking print quality of scanned image	bholt	14.10.2003 10:50:56	SUBMITTED	

Figure 4.44: Print Job Status page

3. Select the printer you sent the job to from the pulldown menu. To view the print job statuses for all printers at one time, select the All Printers option. The status of all your print jobs and the order in which they were submitted to the selected printer(s) appear in the page.
4. To cancel a print job, See *Cancel a Print Job*.

Cancel a Print Job

To cancel one of your print jobs, do the following:

1. Open the Print Job Status page then select a printer as described above.
2. Mark the checkbox(es) next to the print job(s) you wish to cancel.
3. Click the Cancel link in the options bar. All of your selected print jobs will be canceled.

Download a Document

Downloading images may be useful for tasks such as copying and pasting a drawing into a document or for distributing a machine-readable document via e-mail. Documents can be downloaded from multiple locations within the interface including the Document Search Results page, Viewer, Document Properties page, or from within DocPaks.

By default, documents converted to .TIFF for display in the Viewer will be downloaded in the .TIFF format, and files imported in their native format will be downloaded in their original format (e.g., Word, Excel, PDF). However, if both the native file format and a .TIFF image exist for a document, the system enables you to select which file format you wish to download.

Note that when downloading a multiple-page .TIFF file, the system enables you to specify whether to download the file as one multiple-page .TIFF file or as multiple single-page .TIFF files (one file per page).

To download a document, do the following:

1. Click the Download button from any of the pages listed above.

A File Download dialog appears.



Figure 4.45: Download document

2. Select *Save this file to disk*.
3. Click OK.
4. A Save As dialog appears. Navigate to the desired directory to store the file, name it, and click Save.

5. By default, documents downloaded from the Viewer will be downloaded in the .TIFF format (if converted). Native documents will be downloaded in their respective format (e.g., Word, Excel, PDF). However, if both the native file format and a .TIFF image exist for a document, the system enables you to select which file format you wish to download.
6. During the download, DigitalPaper XE sets the content-type (MIME type) to the corresponding setting for the selected document. As a result, the browser will honor the user's current browser configuration accordingly and launch the document into the appropriate application if set to do so in the browser.

Note

If a document contains ViewMark annotations (as described in *Annotate a Document*), the ViewMark objects will not be downloaded with the document.

7. If multiple files were selected for download, they will be compressed as a zip file. In this case, you must unzip the file in order to access the downloaded documents.

Chapter 5

Assembling and Receiving Business Packages

This chapter provides procedures for the following tasks:

- *Create a DocPak.*
- *Publish a DocPak.*
- *Import a DocPak.*
- *Receive a DocPak.*
- *View Public DocPaks.*
- *Print and Download a DocPak.*
- *Search for Documents within a DocPak.*
- *Search for DocPaks.*
- *Edit DocPaks.*
- *Delete an Entire DocPak.*

Create a DocPak

DigitalPaper XE's point-and-click packaging capability lets you assemble and organize multiple, related business documents into a DocPak for the purpose of distributing its contents to other Enterprise Users or Trading Partners. Since DocPak creators are notified of changes to documents stored within his/her DocPak, you can also assemble a DocPak for the sole purpose of being notified if any changes to documents have been made. If you wish to import a DocPak from an externally generated XML or CSV file instead of creating it from scratch, please see *Import a DocPak*.

To create a DocPak, do the following:

1. Click *DocPaks* from the navigation bar at the top of the window (if the Received DocPaks or Public DocPaks page appears, click the *Show My DocPaks* link from the page bar). The My DocPaks page appears as shown below. If this is the first time you are creating a DocPak, the page will be empty.

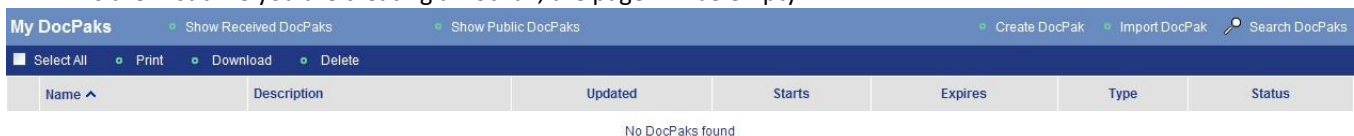

Figure 5.1: My DocPaks

2. Click *Create DocPak* from the page bar.
3. The Create DocPak page appears.

The 'Create DocPak' dialog box has the following fields and controls:

- * Name: Text input field.
- Template: Pull-down menu with 'None' selected.
- Description: Text area with a scroll bar.
- Buttons: 'Save' and 'Cancel'.

Figure 5.2: Create DocPak

- Enter a name for the DocPak as it will be displayed to both you and DocPak recipients. For example, enter “RFP 44692,” “Work Order 99-Q,” “Marketing Collateral,” etc.
- Select the type of business template you wish to apply to the DocPak from the *Template* pull-down menu. The selected template controls the type of information to display with each DocPak to recipients (e.g., DocPak description, start date, organization name, contact information, etc.). Select *None* if you wish to create the DocPak without the assistance of the template.
- Enter a *Description* of the DocPak as it will be displayed to both you and DocPak recipients.
- Click *Save*.
- The DocPak you defined will appear in its own page as shown in the figure below. The name of the DocPak appears in the left pane on the page. The Header tab in the right pane contains a form used to describe the contents of the DocPak based on the template selected.

The 'My DocPaks' interface includes the following elements:

- Navigation Bar:** Print DocPak, Download DocPak, Copy DocPak, Expire DocPak, Back to Search Results.
- DocPak List (Left Pane):** RFP 44692, with links for Line Items, Create Line Item, Attachments, Add Attachment, Recipients, Updates, and Search.
- DocPak Details (Right Pane - Header Tab):**
 - Add documents to DocPak from: Cabinet, Cart
 - * Name: RFP 44692
 - Description: Our company seeks to reward a contract to an electronics company with expertise in creating a viable, stable, efficient and
 - Start Date: 07/04/2010
 - Expiration Date: 04/03/2011 (radio buttons for Never Expire)
 - Status: Active
 - Public:
 - Change Notification: Approve changes before notifying recipients; Automatically notify recipients after a change has been made
 - Receive Email Notification for Publisher:
 - * Company Website: www.yourcompany.com
 - DocPak Publisher: [Empty field]
 - Organization: You Company Name
 - Address: 201 N. Union Street, Suite 140, Alexandria, VA 22314
 - * Phone: 703-740-1100
 - Fax: 703-740-1101
 - Reply No Later Than: [Empty field]
 - Buttons: Save, Reset

Figure 5.3: New DocPak

9. Complete the form contained in the Header tab. All fields listed with an asterisk (*) next to it are required.
10. Enter the name of the DocPak, a description of the DocPak, and the dates the DocPak becomes active (i.e., the date that DocPak recipients may view the contents of the DocPak) and expires (i.e., the date that DocPak recipients can no longer view the contents).
11. Mark the *Public* checkbox if you wish the DocPak to be available to all Enterprise Users at the time of publication (no e-mail notifications will be sent at publication or modification time unless a designated recipient is assigned). Deselect this checkbox if you only want designated recipients to receive the DocPak.
12. Select whether or not you wish to receive a change notification in order to approve revisions to documents stored within the DocPak before making the revised document(s) available to DocPak recipients. For more information, please see *Accept or Reject DocPak Updates (Pending Document Revisions)*.
13. Select whether or not you wish to receive e-mail notifications when a document within the DocPak has been revised or removed from the system by the Indexing Specialist. Receiving e-mail notifications is recommended if you chose the *Change Notification* option of approving document revisions before making the revised document(s) available to DocPak recipients. For more information, See *DocPak Notification*.

Note

Documents that you add to the DocPak after it has been published will only notify designated recipients and will do so automatically, regardless of your selection in the form. In addition, DocPak recipients are automatically notified if a document has been deleted from the DocPak by you or from the system by the Indexing Specialist (as long as it was referenced in the DocPak).

14. Fill out the remaining fields in the form. The fields are defined by the template that was selected earlier.
15. Click *Save*. DocPak recipients (if any) will be notified and allowed access to the DocPak on the Start Date. For more information, See *Specify DocPak Recipients*.

WARNING

If you do not click the *Save* button before going to the next step, the fields within the form will be reset without saving your changes.

Add Documents to a DocPak

A DocPak can be organized in a hierarchical fashion with the most important documents in the top level of the DocPak and supplementary documents added at the Line Item level. For example, if you are preparing a Request for Proposal (RFP), you can place the actual proposal at the top level of the DocPak while placing supplementary reading materials and drawings at the Line Item level.

To add documents to the top level of the DocPak:

1. Click the *Cabinet* link that appears above the Header tab.



Figure 5.4: Click the Cabinet link to add documents to the DocPak

The Search for Documents page appears in the right pane as shown in the figure below.



Figure 5.5: Search for Documents

2. Complete the search form as described in *Search for Documents*.
3. Click *Search*. The Document Search Results are displayed in the right pane in condensed format.



Figure 5.6: Document Search Results page

Note
To refine your search, click the *New Search* link in the Document Search Results page bar to try your search again. For more information, See *Method 2: Perform a Refined Search*.

Documents may also be added to the top-level of the DocPak via the user's cart:

1. Click the *Cart* link that appears above the Header tab.



Figure 5.7: Click the Cart link to add documents to the DocPak The

contents of the user's cart are displayed in the right pane in condensed format.



Figure 5.8: Document Cart Contents page

2. Mark the checkbox next to each document you wish to add to the DocPak. If you wish to add all documents found, mark the *Select All* checkbox.
3. Click *Add to DocPak*.



Figure 5.9: Select document(s) to add to the DocPak

4. A dialog appears asking you if you wish to add the selected documents to the current DocPak. Click *OK*.
5. The My DocPaks page refreshes. Note that the number of documents next to the DocPak name in the left pane has adjusted by the number of documents you just added. If there are multiple pages listed in the right page, and you wish to add the documents from those pages, click the *Next* or *Last* link at the bottom of the Document Search Results page, then perform the same steps listed above to add the documents to the DocPak.
6. To verify the documents were added, click the number next to the DocPak name located in the top of the left pane. The Documents tab will appear in the right pane with the document(s) added as shown below.



Figure 5.10: Documents tab

7. Repeat the steps listed above to add more documents to the top level of the DocPak.

Add Line Items to a DocPak

Line Items are a feature of DocPaks that help you organize related documents. A Line Item represents a subordinate level of a DocPak, analogous to a subfolder in a directory structure that is one level deep (Line Items cannot contain other Line Items). If you do not want Line Items in the DocPak, you may skip this section.

To create a Line Item:

1. Click *Create Line Item* from the left pane.
2. The Create Line Item page displays in the right pane.

Figure 5.11: Create Line Item page

3. Enter a *Name* for the Line Item as it will appear in the DocPak.
4. Select the type of business template you wish to apply to the Line Item from the *Template* pull-down menu. The selected template controls the type of information to display with each Line Item to recipients (e.g. description, requirements, etc.). Select *None* if you want the Line Item header to only display a name and description.
5. Optionally enter a *Description* of the Line Item.
6. Click *Save*. The Line Item you defined appears beneath the "Line Items" label in the left pane of the page. The Header tab in the right pane contains a form used to describe the Line Item's contents; the fields displayed in the form are controlled by the template selected in the previous step (if any).

Figure 5.12: New Line Item

7. Complete the Header tab's form. Each field listed with an asterisk (*) next to it is required.
8. Click the *Save* button.

WARNING

If you do not click the *Save* button before going to the next step, the fields within the form will be reset without saving your changes.

Add Documents to the Line Item

To add documents to the Line Item:

1. Click the *Cabinet* link that appears above the Header tab. The Search for Documents page appears in the right pane.

Figure 5.13: Search for Documents

2. Complete the search form as described in *Search for Documents*.
3. Click *Search*. The Document Search Results are displayed in the right pane.

Document Attributes	Revision	Action
<input type="checkbox"/> ^ Doc No: 25670 Doc Name: NKE Smoke Model Type: Manufacturing Related Site: www.nkesmoke.com	C	[Icons]
<input type="checkbox"/> ^ Doc No: 25671 Doc Name: BT60 Body Tube Model Type: Manufacturing Related Site: www.nkesmoke.com	A	[Icons]
<input type="checkbox"/> ^ Doc No: 25675 Doc Name: Engine Hook Model Type: Manufacturing Related Site: www.nkesmoke.com	A	[Icons]
<input type="checkbox"/> ^ Doc No: 25676 Doc Name: Decal (United States) Model Type: Manufacturing Related Site: www.nkesmoke.com	A	[Icons]
<input type="checkbox"/> ^ Doc No: 25677 Doc Name: Decal (Access Panel) Model Type: Manufacturing Related Site: www.nkesmoke.com	A	[Icons]
<input type="checkbox"/> ^ Doc No: 25678 Doc Name: BT60 Nose Cone Model Type: Manufacturing Related Site: www.nkesmoke.com	A	[Icons]
<input type="checkbox"/> ^ Doc No: 25679 Doc Name: Med Screw Eye Model Type: Manufacturing Related Site: www.nkesmoke.com	A	[Icons]
<input type="checkbox"/> ^ Doc No: 25681 Doc Name: Launch Lug Model Type: Manufacturing Related Site: www.nkesmoke.com	A	[Icons]
<input type="checkbox"/> ^ Doc No: 25682 Doc Name: Shock Cord Mount Model Type: Manufacturing Related Site: www.nkesmoke.com	A	[Icons]

Figure 5.14: Document Search Results

4. Do one of the following:
 - (a) To refine your search, click the *New Search* link in the Document Search Results page bar and try your search again.
 - (b) If you found the documents you were searching for, mark the checkbox next to each document you wish to add to the Line Item. If you wish to add all documents found (on each page), click *Select All*.
5. Click *Add to Line Item*.

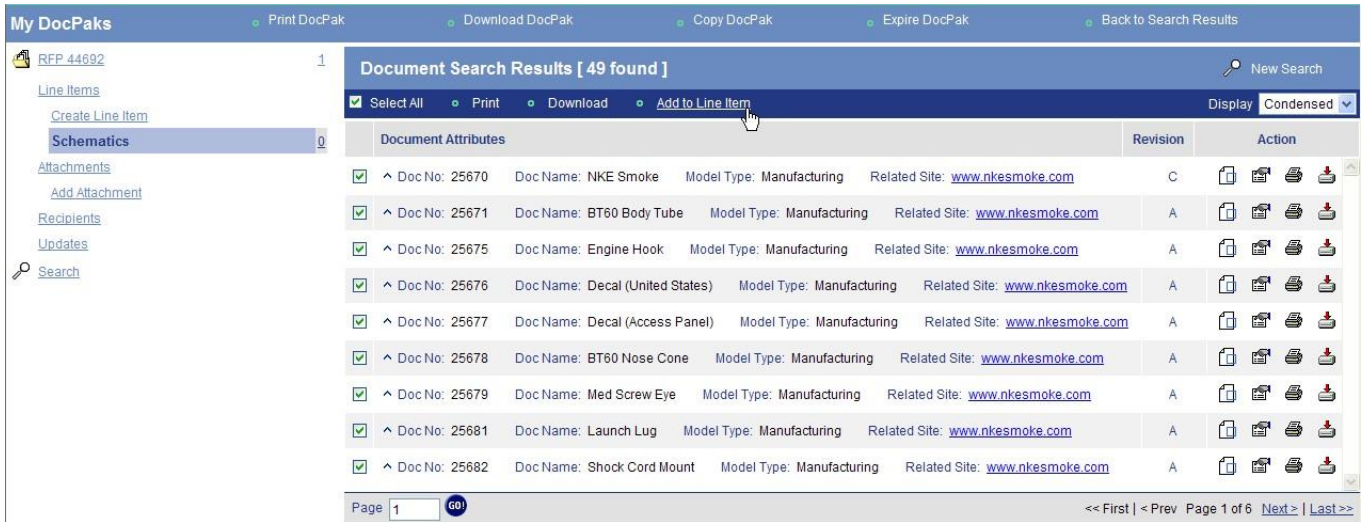

Figure 5.15: Add documents to Line Item

- You will be prompted to add the selected documents to the current Line Item. Click *OK*.
- The My DocPaks page refreshes. Note that the number of documents next to the Line Item name in the left pane has changed to the number of documents you just added. If there are multiple pages listed in the Document Search Results page, and you wish to add the documents from those pages, click the *Next* or *Last* link at the bottom of the page, then perform the same steps listed above to add the documents to the Line Item.
- To verify the documents were added, click the number next to the Line Item name in the left pane. The Documents tab displays all documents added as shown below.

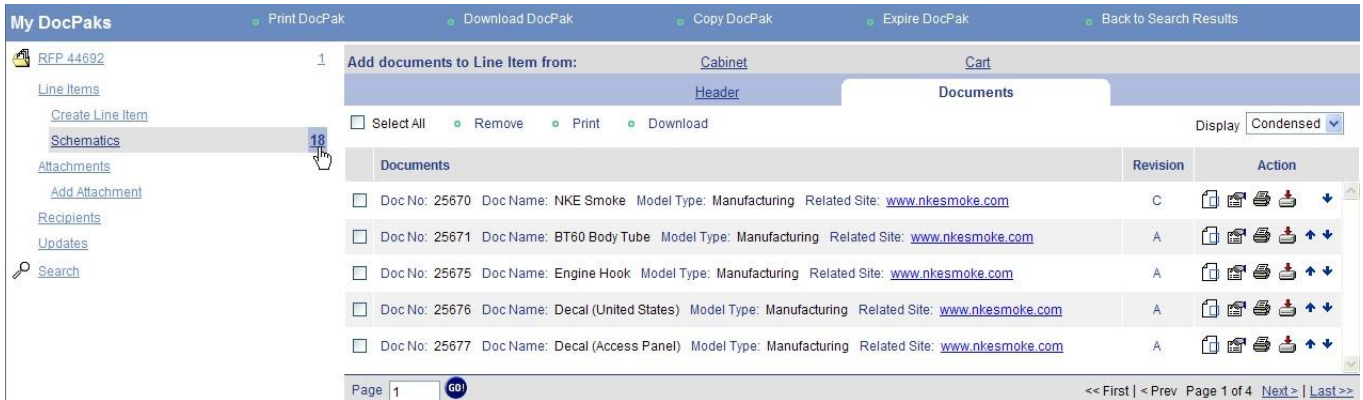

Figure 5.16: Documents tab for a Line Item

- To add more Line Item folders, repeat the steps listed in this section. You can add as many folders as needed to help organize your DocPak.

Documents may also be added to the Line Item via the user’s cart using a procedure similar to that described for adding documents from the cart to the DocPak top level. See *Add Docs from Cart* for more information.

Add Attachments to a DocPak

Attachments are a feature of a DocPak that allow you to add an external document. There is no restriction on the type of file that may be attached to the DocPak. Only the creator of the DocPak may add an attachment. After you attach a file to a DocPak, you can download or delete the attachment as needed.

To attach a file to a DocPak:

1. Click the *Add Attachment* link from the left pane. The Add Attachment page displays in the right pane.



Figure 5.17: Add Attachment to DocPak

2. Click *Browse* to navigate to the location where the file is stored.
3. Enter a *Name* and a *Description* (optional) for the attachment. This is the name the system will display in user interface pages to identify the attachment.
4. Click *Save*. The system adds the attachment to the DocPak. The attachment you added appears as a link under the *Add Attachment* link in the left pane.

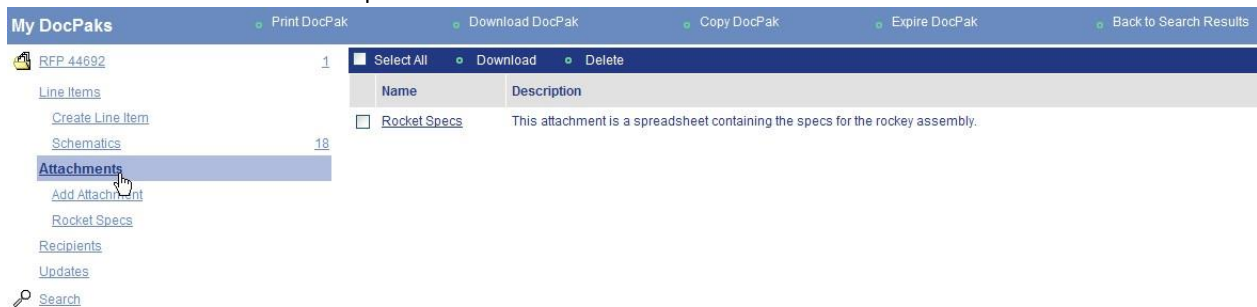

Figure 5.18: DocPak Attachment List Page

DocPak and Line Item Options

Before proceeding with publishing a DocPak, note the following options available to you.

- Remove a Document
You can remove any document listed in the DocPak as described in *Delete Documents from a DocPak or Line Item*.
- Print a Document
You can print the entire contents of a DocPak as described in *Print a DocPak*.
- Download a Document
You can download the entire contents of a DocPak as described in *Download a DocPak*.

Note

To display the Viewer in a separate window, click the Open Viewer into New Window icon located at the top of the Viewer.

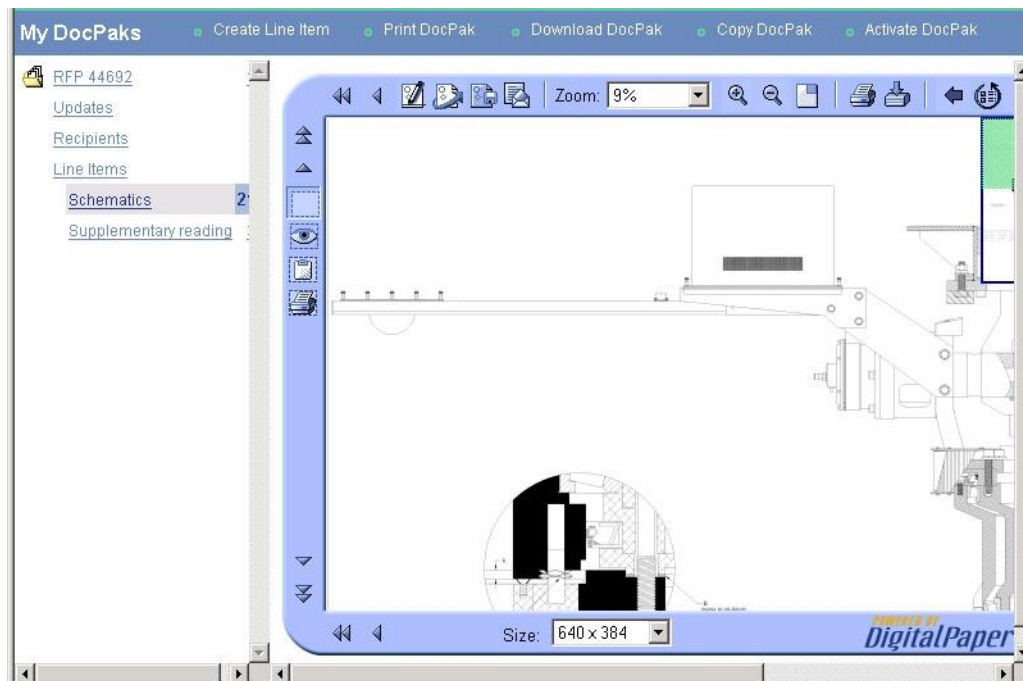

Figure 5.20: Viewer displayed in a separate window

To return to the Documents tab, simply close the window or click the *Close Viewer* button to return to the Documents tab.

For more information on the features available from the Viewer, including how to annotate a document, see *Working with Documents*.

- View a Document’s Properties

To display the properties of a document listed in the Documents tab, a list of revisions for that document (if any), or any ViewMarks associated with the document, click the *Properties* icon for the document of interest.



- Properties tab

The Properties tab appears by default when the *Properties* icon is clicked from the Documents tab.

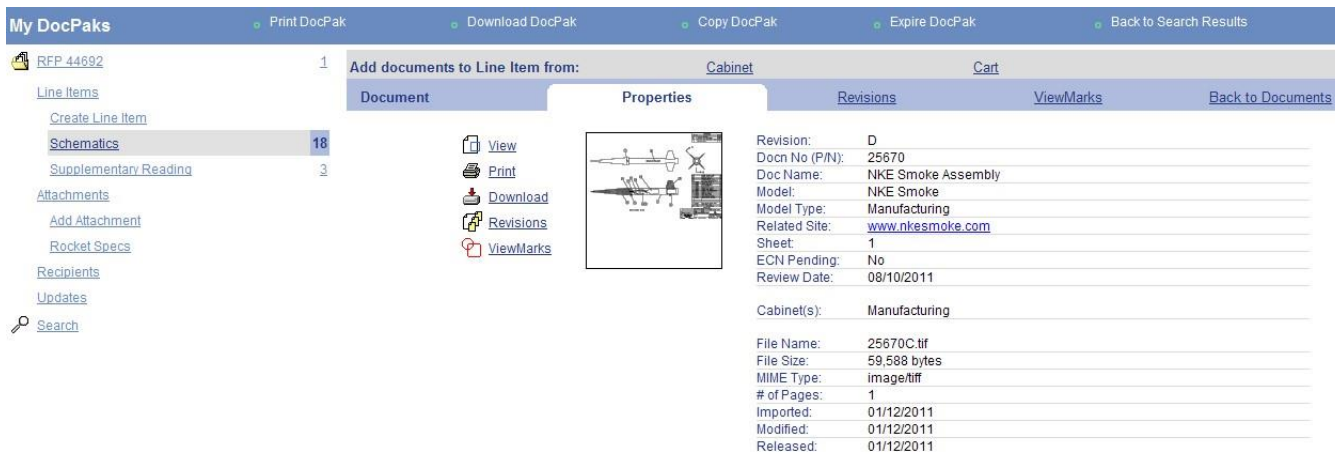

Figure 5.21: Properties tab

This page offers the same features described in *View Document Properties*.

- Revisions tab

Click the *Revisions* link to display all revisions associated with the document (if any).

The screenshot shows the 'Revisions' tab for document RFP 44692. The interface includes a navigation menu on the left and a main content area with a table of revisions.

Add documents to Line Item from:		Cabinet	Cart	
Document	Properties	Revisions	ViewMarks	
<input type="checkbox"/> Select All <input type="button" value="Print"/> <input type="button" value="Download"/>				
Document Attributes			Revision	Action
<input type="checkbox"/>	Docn No (P/N): 25670	Doc Name: NKE Smoke Model Type: Manufacturing Related Site: www.nkesmoke.com	C	<input type="button" value="View"/> <input type="button" value="Print"/> <input type="button" value="Download"/>
<input type="checkbox"/>	Docn No (P/N): 25670	Doc Name: NKE Smoke Assembly Model: NKE Smoke Model Type: Manufacturing Related Site: www.nkesmoke.com	A	<input type="button" value="View"/> <input type="button" value="Print"/> <input type="button" value="Download"/>
<input type="checkbox"/>	Docn No (P/N): 25670	Doc Name: NKE Smoke Assembly Model: NKE Smoke Model Type: Manufacturing Related Site: www.nkesmoke.com	B	<input type="button" value="View"/> <input type="button" value="Print"/> <input type="button" value="Download"/>
<input type="checkbox"/>	Docn No (P/N): 25670	Doc Name: NKE Smoke Assembly Model: NKE Smoke Model Type: Manufacturing Related Site: www.nkesmoke.com	D	<input type="button" value="View"/> <input type="button" value="Print"/> <input type="button" value="Download"/>

Figure 5.22: Revisions tab

This page displays the same information described in *View a Document's Revision History*.

- ViewMarks tab

Click the *ViewMarks* link to display all ViewMarks saved with this document (if any).

The screenshot shows the 'ViewMarks' tab for document RFP 44692. The interface includes a navigation menu on the left and a main content area with a table.

Name	Description	Creator	Date
No ViewMarks found			

Figure 5.23: ViewMarks tab

This page offers the same features described in *Obtain a ViewMark History*.

Note

As a security measure, ViewMarks saved with a document outside of the context of creating a DocPak will not be displayed. To add a ViewMark to the document, return to the Documents tab, click the View icon, then create the ViewMark using the same methods described in *Annotate a Document*.

To return to the Documents tab, click the *Back to Documents* link.

What's Next?

For the purposes of this exercise, go to *Publish a DocPak*.

Publish a DocPak

To publish a DocPak, you must add DigitalPaper XE users and/or groups to the DocPak's recipients list as described below. The recipients specified will receive an e-mail notification when the DocPak becomes active (based on the Start Date set during DocPak creation as described in *Create a DocPak*).

Note

Users and or groups not defined in DigitalPaper XE cannot receive DocPaks. Contact the system administrator if you wish to add additional users to the system.

Specify DocPak Recipients

To specify who receives access to your DocPak:

1. Click *Recipients* from the left pane of the My DocPaks page.

The Recipients page appears as shown below.



Figure 5.24: Recipients page

2. You can add recipients from a list of pre-defined DigitalPaper XE users and/or groups as described in the sections that follow:
 - *Add Recipients from DigitalPaper XE Users List.*
 - *Add Recipients from DigitalPaper XE Groups.*

Note

DocPaks published to external users do not list the other recipient names.

Add Recipients from DigitalPaper XE Users List

To add individual users:

1. Click the *Users* link from the right pane of the Recipients page.
2. The Users tab appears with a list of pre-defined users as shown below. Note that the system displays the name of the creator of the DocPak in red.

My DocPaks

Print DocPak Download DocPak Copy DocPak Expire DocPak Back to Search Results

RFP 44692

Line Items

Create Line Item

Schematics

Supplementary Reading

Attachments

Add Attachment

Rocket Specs

Recipients

Updates

Search

Add to Recipients from: Users Groups Back to Recipients

Select All Add to Recipients Search Users

User Name ^	Name	Company Name
<input type="checkbox"/> ablack	Alex Black	ePlus
<input type="checkbox"/> administrator		
<input type="checkbox"/> bbelichick	Bill Belichick	Patriot Way Corp.
<input type="checkbox"/> bbernardino	Bernie Bernardino	ePlus
<input type="checkbox"/> eu	Enterprise User	ePlus
<input type="checkbox"/> indexer		
<input type="checkbox"/> jharbaugh	John Harbaugh	Raven Defensive Systems, Inc.
<input type="checkbox"/> jjones	Jim Jones	ePlus
<input type="checkbox"/> lsmith	Lovie Smith	Bear Media
<input type="checkbox"/> mmccarthy	Mike McCarthy	Green Bay Packing Co.
<input type="checkbox"/> msmith	Mike Smith	Falcon Engineering LLC
<input type="checkbox"/> mtomlin	Mike Tomlin	Pittsburg Steel Corp.
<input type="checkbox"/> pcarroll	Paul Carroll	ePlus
<input type="checkbox"/> pecarroll	Pete Carroll	Seahawk Systems LLC

Figure 5.25: Add to Recipients from Users

- If you cannot locate a user, click *Search Users* from the page bar to open the Search Users page.

Search Users

User

First Name

Last Name

Company Name

User Email

Search Reset Cancel

Figure 5.26: Search Users page

- In the Search Users page, type the *Username*, *First Name*, *Last Name*, *Company Name*, and/or *User Email* address of the user for whom you are searching. Click *Search*. The results will be displayed in the Users tab.
- Mark the checkbox next to each user you wish to add as a DocPak recipient. If you wish to add all users displayed, mark the *Select All* checkbox.
- Click *Add to Recipients*.
- In the dialog that appears, confirm that you wish to add the selected recipient(s). Click *OK*.

If the DocPak is active, the selected recipients will be mailed a link to the DocPak. If the DocPak is pending, the selected recipients will receive an e-mail with a link to the DocPak on the effective date. For more information, See *Recipient Notification of a Published DocPak*.

When all individual users have been added, do one of the following:

- Click *Back to Recipients* to return to the Recipients page (users added will appear in the page).
- Click *Groups* to add recipients from pre-defined groups as described in *Add Recipients from DigitalPaper XE Groups*.

Send an E-mail to a User

From the main Recipients page or the User's page that lets you designate recipients, you can send any DigitalPaper XE user an e-mail without having to open a separate e-mail client.

To send a user an e-mail from the DigitalPaper XE interface:

1. If not already displayed, click *Users* from the Security category in the left pane of the Administration page to display the Users page.
2. Click the e-mail icon that appears next to the user's name in the Users page. 
3. If not already open, the e-mail application installed on your computer launches and an e-mail message window appears with the user's email address pre-filled in the *To:* field.

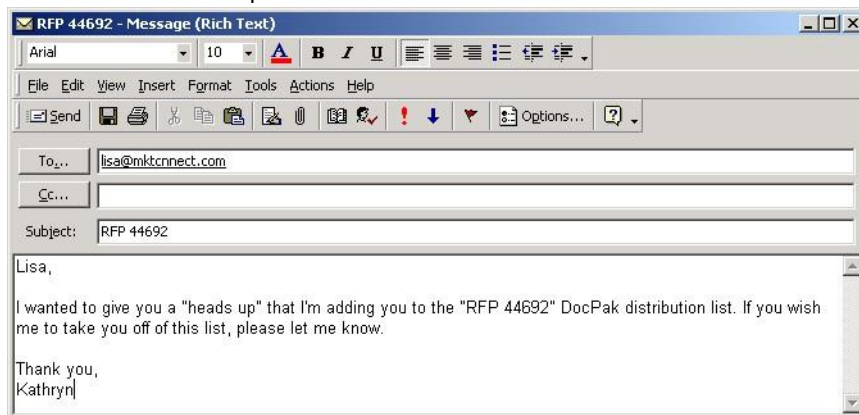

Figure 5.27: E-mail a user

4. Type the message then click the application's *Send* button. The user will receive the message addressed from you.

Add Recipients from DigitalPaper XE Groups

To add groups as DocPak recipients:

1. Click the *Groups* link from the right pane of the Recipients page.
2. The Groups tab appears with a list of pre-defined user groups as shown below.



Figure 5.28: Add to Recipients from Groups

3. Mark the checkbox next to each group whose members you wish to add as DocPak recipients. If you wish to add all groups displayed, mark the *Select All* checkbox.
4. Click *Add to Recipients*. In the dialog that appears, confirm that you wish to add the selected recipient(s).

If the DocPak is active, the selected group members will be mailed a link to the DocPak. If the DocPak is pending, the selected recipients will receive an e-mail with a link to the DocPak on the effective date. For more information, See *Recipient Notification of a Published DocPak*.

5. Click *Back to Recipients* to return to the Recipients page (users added will appear in the page).

DocPak Notification

The following sections describe the notification messages sent to DocPak recipients and the DocPak creator once a DocPak has been published.

Recipient Notification of a Published DocPak When a DocPak becomes active, the DigitalPaper XE system sends recipients an e-mail notifying them that its contents are available for viewing, printing, or download. If an expiration date was entered, the e-mail specifies the number of days the recipient has to access the DocPak until it is no longer available. Once this e-mail is received, DocPak recipients can access the DocPak by clicking a hyperlink within the notification e-mail, or by logging into DigitalPaper XE where the DocPak received is displayed in their "Received DocPaks" page. For more information on this process, See *Receive a DocPak*.

If a DocPak is "public" and no recipients were specified, no e-mail notifications will be sent upon publication.

Publisher and Recipient Notification of DocPak Updates The following provides a list of different scenarios that may occur when a DocPak is updated:

- If a document within a DocPak you have created has been removed from the system by the Indexing Specialist, you (and your DocPak recipients) will be automatically notified of the deletion via e-mail.
- If a document has been revised, you will be notified of the revision only if you chose the *Receive Email Notification* option described in *Create a DocPak*.
- DocPak recipients are notified (and provided access to) new revisions depending on the *Change Notification* option you selected, also described in *Create a DocPak*. If you chose to review the document revision before notifying recipients, please see *Accept or Reject DocPak Updates (Pending Document Revisions)*.
- If you added or deleted a document from the DocPak, the recipients will be notified automatically via e-mail. If you deleted the entire DocPak, recipients will not be notified.

Recipient Notification Suppression of DocPak Updates The following section describes how a DocPak creator may suppress notifications of DocPak updates for all recipients.

- If the XE administrator has enabled notification suppression, the DocPak creator will see an additional checkbox in the DocPak header page.
- If the *Suppress Email Notification for Recipients* checkbox is checked, no notifications pertaining to DocPak updates will be sent to any of the recipients of the DocPak.

My DocPaks [Print DocPak](#) [Download DocPak](#) [Copy DocPak](#) [Expire DocPak](#) [Back to Search Results](#)

RFQ 90-A13 DRAFT [Add documents to DocPak from:](#) [Cabinet](#) [Cart](#)

[Line Items](#) [Header](#) [Documents](#)

[Create Line Item](#)

[Spreadsheets](#) 2

[Supplemental Reading](#) 2

[Attachments](#)

[Add Attachment](#)

[Recipients](#)

[Updates](#)

[Search](#)

*** Name** RFQ 90-A13 DRAFT

Description Please review this final draft. Review should take no longer than 3 days.

Start Date 07/01/2010

Expiration Date
 Never Expire

Status Active

Public

Change Notification Approve changes before notifying recipients
 Automatically notify recipients after a change has been made

Receive Email Notification for Publisher

Suppress Email Notification for Recipients

Allow Recipients to Suppress Email Notification

Requisition Number 1123

Part Number 1210

of Units 44

Date of Shipment 07/14/2010

Figure 5.29: DocPak Recipient Notification Suppression

As an alternative to suppressing notifications to all recipients of a DocPak, the creator may choose to allow each recipient to make the decision on whether to receive notifications.

- If the XE administrator has enabled notification suppression, the DocPak creator will see an additional checkbox in the DocPak header page.
- An *Allow Recipients to Suppress Email Notification* checkbox will be displayed to the creator of the DocPak.

My DocPaks | Print DocPak | Download DocPak | Copy DocPak | Expire DocPak | Back to Search Results

RFQ 90-A13 DRAFT | Add documents to DocPak from: Cabinet | Cart

Line Items

- Create Line Item
- Spreadsheets 2
- Supplemental Reading 2
- Attachments
- Add Attachment
- Recipients
- Updates
- Search

Header | Documents

* Name: RFQ 90-A13 DRAFT

Description: Please review this final draft. Review should take no longer than 3 days.

Start Date: 07/01/2010

Expiration Date: Never Expire

Status: Active

Public:

Change Notification: Approve changes before notifying recipients
 Automatically notify recipients after a change has been made

Receive Email Notification for Publisher:

Suppress Email Notification for Recipients:

Allow Recipients to Suppress Email Notification:

Requisition Number: 1123

Part Number: 1210

of Units: 44

Date of Shipment: 07/14/2010

Save | Reset

Figure 5.30: Allow Recipients to Suppress Notifications

- Once the recipient accesses the DocPak, the recipient will see a *Suppress Email Notification* checkbox.
- If the recipient checks this box, no notifications will be sent to this particular recipient when the DocPak is updated.

Received DocPaks | Print DocPak | Download DocPak | Copy DocPak | Back to Search Results

RFQ 90-A13 DRAFT | Header | Documents

Line Items

- Spreadsheets 2
- Supplemental Reading 2
- Attachments
- Updates
- Search

Name: RFQ 90-A13 DRAFT

Description: Please review this final draft. Review should take no longer than 3 days.

Start Date: 07/01/2010

Expiration Date: Never Expire

Status: Active

Requisition Number: 1123

Part Number: 1210

of Units: 44

Date of Shipment: 07/14/2010

Suppress Email Notification:

Save

Figure 5.31: Individual Recipient Notification Suppression

Note
 The creator cannot enable both global and individual recipient notification suppression. When the *Suppress Email Notification for Recipients* checkbox is checked, the *Allow Recipients to Suppress Email Notification* checkbox will be disabled.

Note
 Update notifications are sent on a scheduled basis to prevent multiple e-mails being sent for a series of updates made to a DocPak within a short time period.

- If a DocPak is "public" and no recipients were specified, no e-mail notifications will be sent to public users upon document revision or DocPak deletion.

Accept or Reject DocPak Updates (Pending Document Revisions) If you choose to review document revisions before making them available to DocPak recipients, do the following:

1. Do one of the following:
 - (a) Open the e-mail notification message (if any) and review the information it contains. Click the URL contained within the e-mail message to access the updated DocPak in the My DocPaks page. Click the *Updates* link from the My DocPaks page.
 - (b) From the list of DocPaks in the main My DocPaks page, select the DocPak that contains the revised document, then click the *Updates* link.
2. The Updates page displays all document revisions in the Pending tab.

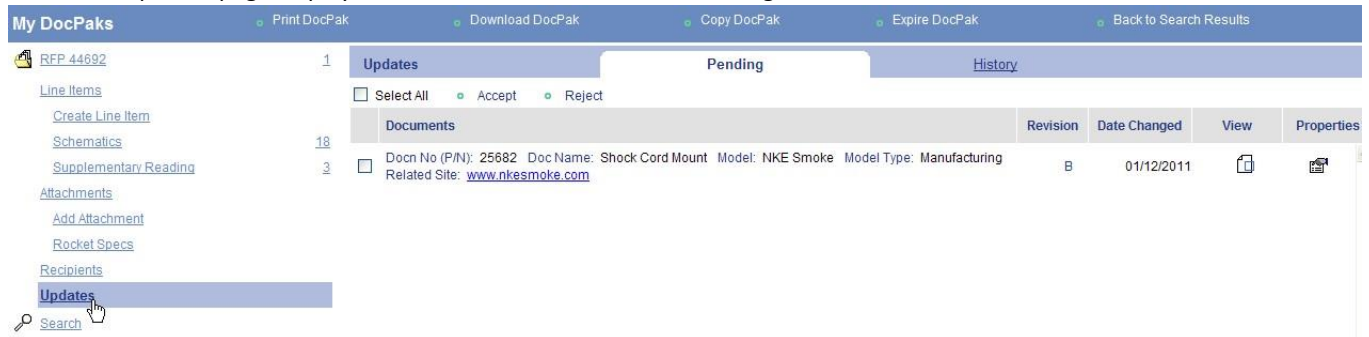

Figure 5.32: My DocPak which has been updated

Note

Before accepting or rejecting an update, view the document, its properties, and/or update history. To view an image of the revised document (or to download the document if its file type is not supported by the Viewer), click the *View* icon. For more information, follow the steps listed in *View the Document*.

To view the revised document's properties, click the Properties icon. For more information on viewing a document's properties, follow the steps listed in *View a Document's Properties*.

To view the complete update history for the DocPak, click the *History* tab link. When done, click the *Pending* tab link.

3. Do one of the following:
 - To accept the revision, mark the checkbox next to the document(s) listed in the Pending tab, then click the *Accept* link. Designated DocPak recipients will be notified of the update via e-mail.

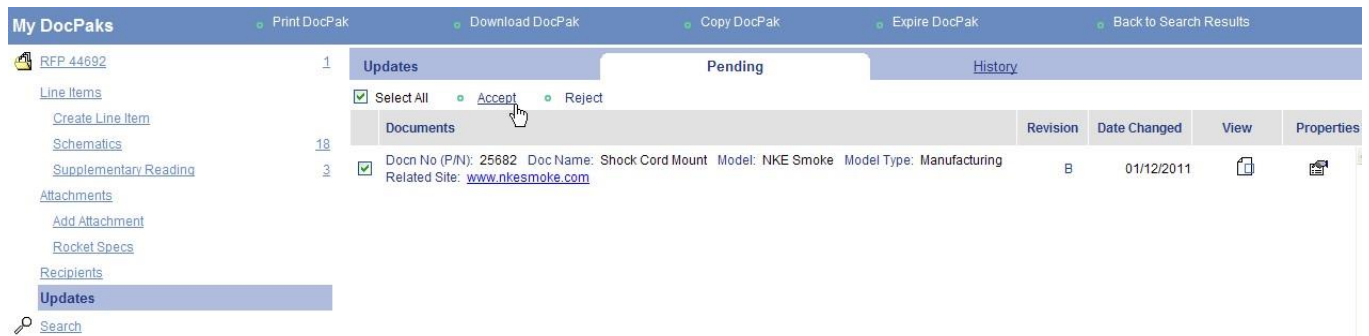

Figure 5.33: Updates page

- To reject the revision, mark the checkbox next to the document(s) listed in the Pending tab, then click the *Reject* link. In this case, designated DocPak recipients will not receive an e-mail notification of the update nor will they have access to the revised document. They will only have access to the document version sent as part of the DocPak.
- Neither accept nor reject the revision. Designated DocPak recipients will not receive an e-mail notification of the update nor will they have access to the revised document. They will only have access to the document version sent as part of the DocPak. You may accept or reject the revision at a later time.

Import a DocPak

As an alternative to creating a DocPak from scratch (as described in *Create a DocPak*), you can import an XML file that defines the DocPak's contents (e.g., DocPak header information, documents to include, recipients).

This section provides the guidelines and procedures an Enterprise User uses to import DocPaks.

Import Guidelines

Before you import a DocPak, it is recommended you read and adhere to the guidelines in this section.

Locate XML File Directory Before you use the interface to import the DocPak, locate the XML to be imported. You will be asked to specify the name and location of the XML file that is being used to define the DocPak.

Understand the Required XML File Format Although it is not required that you understand the XML file's format, it may be helpful if you encounter problems during the import process. The following is a list of guidelines as they pertain to an XML file's content:

- Each XML file contains five blocks that define the data to include in a DocPak:
- The header block defines the DocPak's header information (e.g., name, description, start and expiration date, change notification settings, whether or not the DocPak is public, and the template to use when creating the DocPak). Additional header attributes may be listed according to the selected DocPak template.
- The recipients block defines the DocPak's recipients (i.e., users and/or groups).
- The documents block defines the document search criteria, which tells the system which cabinets to search for documents to be included in the DocPak.
- The DocPak's name is the only required field to be defined if the DocPak is not going to be published immediately (as determined by its start date). If a DocPak is going to be published upon successful import, then the DocPak's name, start date, attributes designated as "required" by the selected template, recipients, and document search criteria are required. Optional fields which are not provided within the XML file will be set to system defaults.
- All users and groups specified within the XML file must have an account in the DigitalPaper XE system with Enterprise User or Trading Partner privileges assigned in order to be registered as recipients of a DocPak.
- Each search block within the documents block represents a separate document search based on a document's attributes. The resulting list of documents from each search will be added to the DocPak. If no revision is provided in the XML file, the system will use the current revision.
- The line-items block defines the Line Items that will be associated with this DocPak. The line-items block may contain one or more line-item sections. Each line-item section must define the name and optionally define the description, template and documents.

- The attachments block defines Attachments associated with the DocPak. The attachments block may contain one or more attachment sections. Each attachment section must define the path and filename to the attachment, the name of the attachment and optionally define the description.

Sample XML File The following is a sample that demonstrates an XML file's content and format:

```
<?xml version="1.0" encoding="UTF-8" ?>

<!-- The following line should be uncommented to validate the format of this file. Make sure the path to the DTD is valid before validating.
<!DOCTYPE docpak SYSTEM "D:/dp_docpak_import_1_0.dtd">

-->

  <docpak>
    <header>
      <name>Rocket Schematics Update</name>
      <description>This DocPak contains updated engineering drawings.</description>
      <start-date>06/24/2003</start-date> <expiration-date>07/28/2003</expiration-date>
      <auto-update>>false</auto-update> <receive-email>>true</receive-email>
      <public>>false</public>
      <template name="ECN Template">
        <template-attribute name="ECN Pending" value="true" />
      </template>
    </header>
    <recipients>
      <user>bholt</user>
      <user>dhay</user>
      <user>fkuttas</user>
      <group>Engineering</group>
      <group>Suppliers</group>
    </recipients>
    <documents>
      <search cabinet="Manufacturing">
        <document-attribute name="DRAWINGNO" value="010033" />
        <document-attribute name="SHEET" value="1" />
      </search>
      <search>
        <document-attribute name="DOCNO" value="000014" />
        <document-attribute name="REVISION" value="A" />
      </search>
      <search cabinet="Engineering">
        <document-attribute name="DOC_ID" value="010042" />
        <document-attribute name="SHEET" value="1" />
      </search>
    </documents>
    <line-items>
      <line-item>
        <name>Schematics</name>
```

```

<description>This folder contains the schematics associated with the NKE Rocket
Assembly.</description>
<documents>
    <search cabinet="Schematics">
        <document-attribute name="DOCNO" value="NKE-SCHEMATICS" />
        <document-attribute name="REVISION" value="C"
        />
    </search>
</line-item>
</line-items>
<attachments>
    <attachment> <filename>C:/Uploads/UpdatedSchematics.xls</filename>
        <name>Updated Schematics</name>
        <description>The attached spreadsheet contains updated schematics on some
        parts.</description>
    </attachment>
</attachments>
</docpak>

```

Validate XML Files To ensure that the XML file will be imported correctly, you should validate it against the Document Type Definition (DTD) file provided with DigitalPaper XE.

The DTD defines what is allowed in the XML file. If the file does not validate, you must fix the problem in order for the DocPak to import correctly.

Import the DocPak

To import a DocPak:

1. Click *DocPaks* from the navigation bar at the top of the window.
2. Click the *Import DocPak* link from the My DocPaks, Received DocPaks, or Public DocPaks page.
3. The Import DocPak page appears.
4. Select XML from the *Type of Import* drop down.

Figure 5.34: Import DocPak

5. Type the path and import name of the XML file that contains the DocPak's definition or simply click the *Browse...* button and navigate the file's location.
6. Once the file's path and location have been entered, click the *Next* button.

7. A second Import DocPak page appears. The fields with values specified in the import file will be prepopulated.

Import DocPak

* Name

Template

Description

Start Date

Expiration Date 07/28/2011 Never Expire

Public

Change Notification Approve changes before notifying recipients
 Automatically notify recipients after a change has been made

Receive Email Notification for Publisher

Figure 5.35: Import DocPak

8. Once you have reviewed and/ or entered the information, click *Finish*.
9. The DocPak is created according to the data entered in the form, as well as the data defined in the import file.

If the DocPak is created successfully, you are taken to the DocPak Header page where you may view, edit, and/or save the DocPak contents using the same methods as described in *Create a DocPak*.

My DocPaks Print DocPak Download DocPak Copy DocPak Activate DocPak Back to Search Results

Rocket Schematics Update Add documents to DocPak from: Cabinet Cart

Line Items Create Line Item Attachments Add Attachment Recipients Updates Search

Header Documents

* Name: **Rocket Schematics Up**

Description: This DocPak contains updated engineering drawings.

Start Date: 02/01/2011

Expiration Date: 07/28/2011 Never Expire

Status: Pending

Public:

Change Notification: Approve changes before notifying recipients Automatically notify recipients after a change has been made

Receive Email Notification for Publisher:

Save **Reset**

Figure 5.36: Imported DocPak

A DocPak may also be manually imported using a CSV file and/or manually entering the search criteria of documents to add to the DocPak.

To import data from a CSV file, do the following:

1. Click the *Import DocPak* link from the My DocPaks, Received DocPaks, or Public DocPaks page.
2. The Import DocPak page appears.
3. Select CSV from the *Type of Import* drop down.

Import DocPak Type of Import: CSV

* Search Attributes: **DOCNO** Attribute List

* Search Attribute Types: **TEXT**

Data Delimiter: Comma [,]

Import File: C:\Development\Import\DocPak\ Browse...

Additional Data: 256*
2010*

Next **Cancel**

Figure 5.37: Import DocPak

4. Select the *Search Attributes* by either typing them in manually or by clicking on the *Attribute List* link and selecting the attributes from there. By selecting the attributes from the *Attribute List*, the *Search Attributes* and *Search Attribute Type* fields will be filled in automatically.
5. Click the *Browse...* button and navigate to the file that contains the search criteria for the documents that will be added to the DocPak.
6. In addition or instead of browsing to a file you may enter search criteria, one line at a time, in the *Additional Data* text area.
7. Once the file's path and location have been entered, click the *Next* button.
8. A second Import DocPak page appears. The field values must be manually entered with CSV import type.

Import DocPak

Click here to view the [list of search criteria](#) that failed to return any results.

* Name

Template None ▼

Description

Start Date !

Expiration Date !

Never Expire

Public

Change Notification Approve changes before notifying recipients

Automatically notify recipients after a change has been made

Receive Email Notification for Publisher

Previous
Finish
Cancel

Figure 5.38: Import DocPak

9. If search criteria existed that did not produce any search results, click on the *list of search criteria* link to view the search criteria that did not produce any results.
10. Once you have reviewed and/ or entered the information, click *Finish*.

- The DocPak is created according to the data entered in the form, as well as the data defined in the import file. If the DocPak is created successfully, you are taken to the DocPak Header page where you may view, edit, and/or save the DocPak contents using the same methods as described in *Create a DocPak*.

Note

If the DocPak was not created successfully, a detailed error message will be displayed.

To add line items, follow the same procedures described in *Add Line Items to a DocPak*.

Receive a DocPak

As an Enterprise User, you can receive DocPaks from other Enterprise Users such as fellow employees. This section describes the ways you can access a DocPak sent to you, view its contents, and updates (if any).

View a Received DocPak

There are two ways to access DocPaks sent to you by other enterprise users as described below.

Method 1: Access a Received DocPak from E-mail Notification Message

When you have been designated as a DocPak recipient, you will receive an e-mail message with a link to the DocPak on the day that the DocPak becomes active.

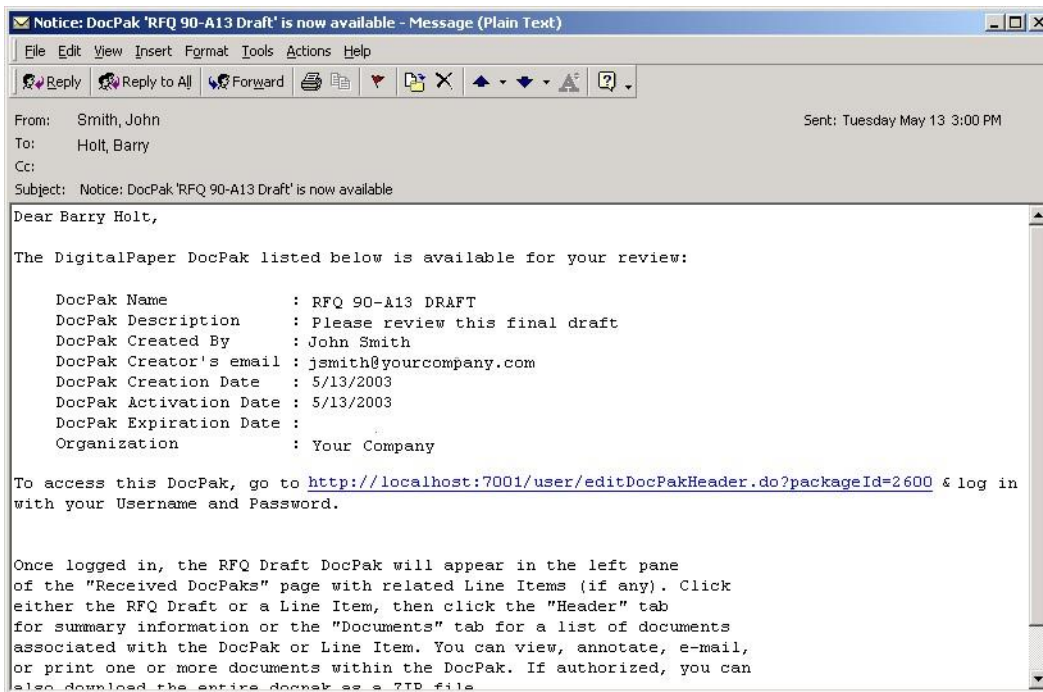

Figure 5.39: DocPak notification

- Open the e-mail notification message and review the information it contains.
- Click the URL contained within the e-mail message to access the DocPak.
- If you are not currently logged into the system, enter your username and password in the User Login page.
- Once logged in, the Received DocPaks page automatically appears with the header information of the associated DocPak displayed.

The screenshot shows a web interface for 'Received DocPaks'. At the top, there are navigation links: 'Print DocPak', 'Download DocPak', 'Copy DocPak', and 'Back to Search Results'. Below this is a header for 'RFQ 90-A13 DRAFT' with a '5' in a box. There are two tabs: 'Header' (selected) and 'Documents'. On the left, there are links for 'Line Items', 'Spreadsheets', 'Supplemental Reading', 'Attachments', 'Updates', and 'Search'. The main content area displays the following details:

- Name: RFQ 90-A13 DRAFT
- Description: Please review this final draft. Review should take no longer than 3 days.
- Start Date: 07/01/2010
- Expiration Date: Never Expire
- Status: Active
- Requisition Number: 1123
- Part Number: 1210
- # of Units: 44
- Date of Shipment: 07/14/2010

Figure 5.40: Received DocPak

5. Go to *View Received DocPak Contents*.

Method 2: View Received DocPaks List

To view a complete list of DocPaks you have received, do one of the following based on the page currently displayed:

- If the My DocPaks page or Public DocPaks page is currently displayed, click the *Show Received DocPaks* link from the page bar.
- If any other page is displayed (e.g., Viewer, Search Results page), click the *DocPaks* link from the navigation bar, then click the *Show Received DocPaks* link from the page bar.

The Received DocPaks page appears with a list of all DocPaks received to date that have an "Active" status.

The screenshot shows a table titled 'Received DocPaks' with a search bar and navigation links. The table has the following columns: Name, Description, Updated, Starts, Expires, Type, and Status. The data rows are:

Name ^	Description	Updated	Starts	Expires	Type	Status
<input type="checkbox"/> Ensuring Quality	QA/QC programs for project Horizon	01/11/2011	05/12/2010	05/11/2011		Active
<input type="checkbox"/> New Marketing Material	This DocPak contains the latest versions of material that are now available from our website.	01/11/2011	01/11/2010			Active
<input type="checkbox"/> RFQ 90-A13 DRAFT	Please review this final draft. Review should take no longer than 3 days.	01/12/2011	07/01/2010		RFQ	Active
<input type="checkbox"/> Seminars	This DocPak contains the documents that describe upcoming seminars, including schedule.	01/12/2011	08/01/2010		Company Programs	Active

Figure 5.41: Received DocPak List

Before proceeding, note the following options:

- To sort the DocPaks listed in this page, click the column header you wish to sort by (i.e., click Name, Description, Updated, Effective, Expires, Type or Status). Click the same column a second time to change the sort order from ascending to descending. [Name ^](#)
- To search for DocPaks you have received, see *Search for DocPaks*.
- If you wish to print or download a DocPak displayed in this page, see *Print and Download a DocPak*.
- To view the contents of a received DocPak, click the DocPak's name from the Name column, then see *View Received DocPak Contents*.

View Received DocPak Contents

By default, the received DocPak's Header tab is displayed with summary information for the entire DocPak.



Figure 5.42: Received DocPak displayed

Before proceeding, note the following options:

- You can print or download the entire contents of a DocPak by selecting *Print DocPak* or *Download DocPak*, respectively. For more information, See *Print and Download a DocPak*.
- You may also copy the received DocPak by clicking the *Copy DocPak* link. This will copy the received DocPak and place it in the My DocPaks page. For more information, See *Copy a DocPak*.
- To display the list of documents within the top level of the DocPak, either click the number next to the DocPak name located in the top of the left pane, or click the *Documents* link in the right pane. The Documents tab appears with a list of all documents contained within the top level of the DocPak.



Figure 5.43: Documents contained with the top level of the received DocPak

From this page you have the same options available to you as described in *DocPak and Line Item Options*, except you cannot remove documents.

- To view Line Items summary information, click the *Line Items* link in the left pane of the Received DocPaks page. A summary of each Line Item is displayed.



Figure 5.44: Line Items summary

- To view the contents of an individual Line Item, click the name of the Line Item from either the left or right pane.



Figure 5.45: Individual Line Item header

- Click the *Documents* tab to display the list of documents within the Line Item.



Figure 5.46: Documents contained with the Line Item

From this page you have the same options available to you as described in *DocPak and Line Item Options*, except you cannot remove documents.

View Received DocPak Updates

If a document within the DocPak has been added, updated, or removed, you will receive an e-mail notification message with a high level summary of the changes made to the DocPak.

Note

You will be notified of updates (i.e., revisions) only if the DocPak creator has set up the system to notify you automatically or has approved of the update first.

To view received DocPak updates, do the following:

1. Open the e-mail notification message and review the information it contains.

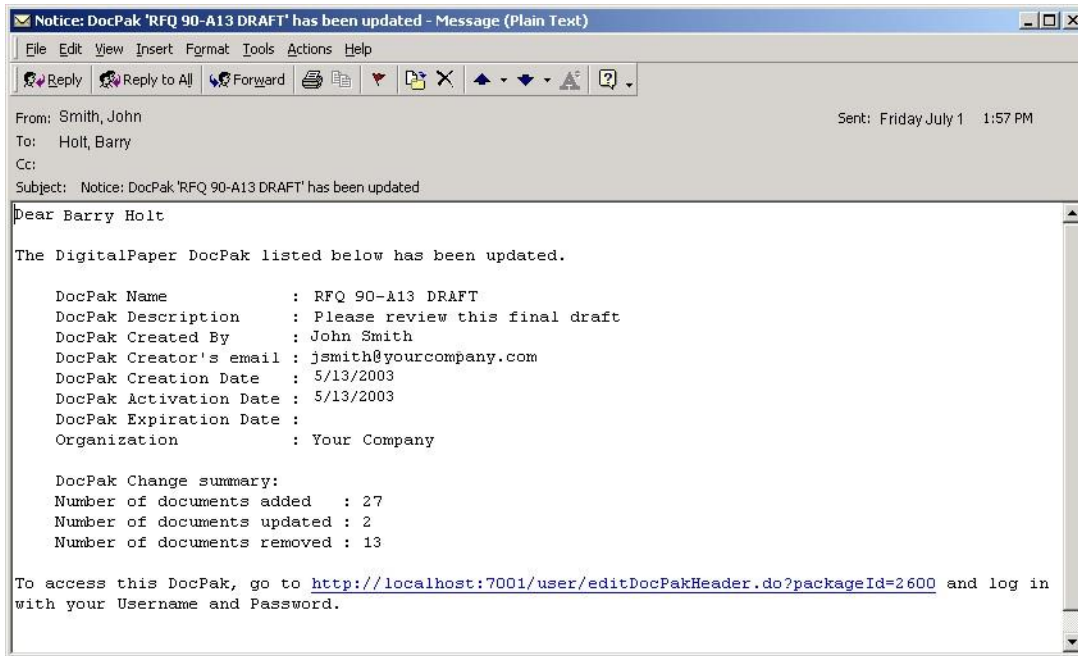

Figure 5.47: DocPak update notification

2. Click the URL contained within the e-mail message to access the updated DocPak.
3. If you are not currently logged into the system, enter your username and password in the User Login page.
4. Once logged in, the Received DocPaks page automatically appears with the header information of the associated DocPak displayed.



Figure 5.48: Received DocPak which has been updated

5. To view a description of the updates that have been made, click the *Updates* link in the left pane of the DocPak to open the Updates page.

Received DocPaks		Print DocPak	Download DocPak	Copy DocPak	Back to Search Results	
RFQ 90-A13 DRAFT						
Line Items						
Spreadsheets						
Supplemental Reading						
Attachments						
Updates						
Search						
Documents		Revision	Date Changed	Location	Action	View
Doc No: RFQ 90-A13 Sheet: 1 Doc Name: RFQ Draft		A	01/12/2011	RFQ 90-A13 DRAFT	Removed via Update	
Doc No: RFQ 90-A13 Sheet: 1 Doc Name: RFQ Draft		B	01/12/2011	RFQ 90-A13 DRAFT	Added via Update	
Spreadsheet Name: Preliminary Figured Required Reading: Yes Created on: 03/28/2010		1	01/12/2011	Spreadsheets	Added	
Spreadsheet Name: Schedule Required Reading: Yes Created on: 03/28/2010		B	01/12/2011	Spreadsheets	Added	
Spreadsheet Name: Schedule Required Reading: Yes Created on: 03/28/2010		B	01/12/2011	Spreadsheets	Deleted	
Spreadsheet Name: Preliminary Figured Required Reading: Yes Created on: 03/28/2010		1	01/12/2011	Spreadsheets	Deleted	

Figure 5.49: Updates page

- The updates displayed will consist of documents that have been added, revised, or deleted since the first time the DocPak was created.
- To view an image of the updated document (or to download the document if its file type is not supported by the Viewer), click the *View* icon . For more information, follow the steps listed in *View a Document Image*.

View Public DocPaks

To view a complete list of public DocPaks, click the *Show Public DocPaks* link from the My DocPaks or Received DocPaks page bar. The Public DocPaks page appears with a list of all DocPaks published to date that have an "Active" status.

Public DocPaks		Show My DocPaks	Show Received DocPaks	Create DocPak	Import DocPak	Search DocPaks
Select All Print Download Delete						
Name ^	Description	Updated	Starts	Expires	Type	Status
<input type="checkbox"/> Introduction to DPXE	This DocPak contains the material and sample date from DigitalPaper's into course.	01/12/2011	08/22/2010		Training Material	Active
<input type="checkbox"/> Project Horizon Collateral	This DocPak contains the latest set of marketing collateral for Project Horizon.	01/12/2011	06/22/2010		Marketing Literature	Active
<input type="checkbox"/> Project Horizon	The purpose of this DocPak is to communicate the design standards, conventions and idioms to be used in the design of the system.	01/12/2011	03/17/2010		Design Guidelines	Active
<input type="checkbox"/> Seminars	This DocPak contains the documents that describe upcoming seminars, including schedule.	01/12/2011	08/01/2010		Company Programs	Active

Figure 5.50: Public DocPak List

The options for this page are identical to those described in *Receive a DocPak* except Public DocPaks do not require recipients to be assigned to it when published. In this case, e-mail change notifications will only be sent to the DocPak creator. Note that the DocPak creator has the option to add recipients to the Public DocPak, although these recipients will not be displayed when viewing the Public DocPak.

Print and Download a DocPak

DocPaks can be printed (one at a time) or downloaded from any My DocPaks, Received DocPaks, or Public DocPaks page as described in the sections below.

Print a DocPak

From the My DocPaks or Received DocPaks pages, you have two options to print a DocPak:

- From the main My DocPaks, Received DocPaks, or Public DocPaks page that lists all DocPaks, mark the checkbox next to the DocPak you wish to print, then click the *Print* link from the option bar.

Name ^	Description	Updated	Starts	Expires	Type	Status
<input type="checkbox"/> Ensuring Quality	QA/QC programs for project Horizon	01/11/2011	05/12/2010	05/11/2011		Active
<input type="checkbox"/> Focus Group Results	This DocPak contains the results of the focus group conducted in Boise, Idaho last week.	01/12/2011	01/11/2011			Active
<input type="checkbox"/> Introduction to DPXE	This DocPak contains the material and sample date from DigitalPaper's into course.	01/12/2011	08/22/2010		Training Material	Active
<input type="checkbox"/> New Marketing Material	This DocPak contains the latest versions of material that are now available from our website.	01/11/2011	01/11/2010			Active
<input type="checkbox"/> Project Horizon Collateral	This DocPak contains the latest set of marketing collateral for Project Horizon.	01/12/2011	06/22/2010		Marketing Literature	Active
<input type="checkbox"/> Project Horizon	The purpose of this DocPak is to communicate the design standards, conventions and idioms to be used in the design of the system.	01/12/2011	03/17/2010		Design Guidelines	Active
<input type="checkbox"/> Proposal 339.B1	Proposal to develop functionality extensions to Rotator Wing module.	01/11/2011	01/11/2010	05/17/2011		Active
<input checked="" type="checkbox"/> RFP 44692	Our company seeks to reward a contract to an electronics company with expertise in creating a viable, stable, efficient and well designed guidance system for the NKE Armoke Rocket. The chosen vendor will assist in prototyping, testing, and evaluating the guidance system.	01/12/2011	07/04/2010	04/03/2011	RFP	Active
<input type="checkbox"/> RFQ 90-A13 DRAFT		01/12/2011				Pending
<input type="checkbox"/> Rockets Schematics Update	This DocPak contains updated engineering drawings.	01/12/2011			RFP	Pending
<input type="checkbox"/> Seminars	This DocPak contains the documents that describe upcoming seminars, including schedule.	01/12/2011	08/01/2010		Company Programs	Active

Figure 5.51: Print DocPaks from the option bar

- Alternately, from the DocPaks page that displays the contents of an individual DocPak, click *Print DocPak* from the page bar.

My DocPaks Print DocPak Download DocPak Copy DocPak Expire DocPak Back to Search Results

RFP 44692 1 Add documents to DocPak from: Cabinet Cart

Line Items

- Create Line Item
- Schematics 18
- Supplementary Reading 3

Attachments

- Add Attachment
- Rocket Specs
- Recipients
- Updates
- Search

* Name: RFP 44692

Description: Our company seeks to reward a contract to an electronics company with expertise in creating a viable, stable, efficient and

Start Date: 07/04/2010

Expiration Date: 04/03/2011 (radio button selected) / Never Expire (radio button unselected)

Figure 5.52: Print a DocPak from the page bar

The available print options are the same as described in *Printing a Document*.

Download a DocPak

If you are not in a DocPaks page, click *DocPaks* from the navigation bar at the top of the window.

From My DocPaks, Received DocPaks, or Public DocPak pages, you have two options to download the DocPak:

- From the main My DocPaks or Received DocPaks page, mark the checkbox next to each DocPak you wish to download (to download the contents of all DocPaks displayed, click *Select All*) then click the *Download* link from the option bar.

Name ^	Description	Updated	Starts	Expires	Type	Status
<input type="checkbox"/> Ensuring Quality	QA/QC programs for project Horizon	01/11/2011	05/12/2010	05/11/2011		Active
<input type="checkbox"/> Focus Group Results	This DocPak contains the results of the focus group conducted in Boise, Idaho last week.	01/12/2011	01/11/2011			Active
<input type="checkbox"/> Introduction to DPXE	This DocPak contains the material and sample date from DigitalPaper's into course.	01/12/2011	08/22/2010		Training Material	Active
<input type="checkbox"/> New Marketing Material	This DocPak contains the latest versions of material that are now available from our website.	01/11/2011	01/11/2010			Active
<input type="checkbox"/> Project Horizon Collateral	This DocPak contains the latest set of marketing collateral for Project Horizon.	01/12/2011	06/22/2010		Marketing Literature	Active
<input type="checkbox"/> Project Horizon	The purpose of this DocPak is to communicate the design standards, conventions and idioms to be used in the design of the system.	01/12/2011	03/17/2010		Design Guidelines	Active
<input type="checkbox"/> Proposal 339.B1	Proposal to develop functionality extensions to Rotator Wing module.	01/11/2011	01/11/2010	05/17/2011		Active
<input type="checkbox"/> RFP 44692	Our company seeks to reward a contract to an electronics company with expertise in creating a viable, stable, efficient and well designed guidance system for the NKE Amo Rocket. The chosen vendor will assist in prototyping, testing, and evaluating the guidance system.	01/12/2011	07/04/2010	04/03/2011	RFP	Active
<input checked="" type="checkbox"/> RFQ 90-A13 DRAFT		01/12/2011				Pending
<input type="checkbox"/> Rockets Schematics Update	This DocPak contains updated engineering drawings.	01/12/2011			RFP	Pending
<input type="checkbox"/> Seminars	This DocPak contains the documents that describe upcoming seminars, including schedule.	01/12/2011	08/01/2010		Company Programs	Active

Figure 5.53: Download one or more DocPaks from the main DocPaks page

- Alternately, click the name of a DocPak on the main My DocPaks or Received DocPaks page to display the contents of that DocPak, then click *Download DocPak* from the page bar.

Documents	Revision	Action
<input type="checkbox"/> Doc No: RFQ 90-A13 Sheet: 1 Doc Name: RFQ Draft	A	[Icons]
<input type="checkbox"/> Doc No: 25670 Sheet: 1 Doc Name: Nike Smoke Assy.	A	[Icons]
<input type="checkbox"/> Doc No: 25800 Sheet: 1 Doc Name: Sentry Rocket Assy.	B	[Icons]
<input type="checkbox"/> Doc No: 25808 Sheet: 1 Doc Name: Nose Cone	B	[Icons]

Figure 5.54: Download an individual DocPak

A file download dialog appears. Follow the steps listed in *Download a Document* to download the DocPak. The DocPak is downloaded as a zip file containing a directory structure identical to that displayed in the DocPaks page.

Download a DocPak With Offline Navigation

Note
The XE administrator must enable and configure this functionality so that a recipient of a DocPak may use this feature.

The DocPak Table of Contents, included within the DocPak Zip file, allows a recipient to use a web browser to navigate through a downloaded version of the complete DocPak. This includes the top level DocPak, Line Items and Attachments. The DocPak Table of Contents contains a directory structure identical to that displayed in the DocPaks page. The user may navigate through the DocPak Table of Contents in the same manner as the user would navigate through the DocPak in the XE application.

To use this functionality, perform the following steps:

1. Download the DocPak as described in *Download a DocPak* on the previous page.
2. Once the zip file is downloaded, extract the contents to local storage. When extracting the files from the zip, make sure the *Use folder names* checkbox is checked so that the directory structure is preserved.
3. Navigate to the directory that was specified to extract the files from the zip.

4. A file named “Index.htm” should be present. Double click on this file and it will open in your default web browser.

Line Items	Header	Documents
RFP 44692		
Schematics	18	
Supplementary Reading	3	
Attachments		
Rocket Specs		
Updated Schematics		
RFP_44692_Index_18-Jan-2011.zip		
13 Index		

Name	RFP 44692
Description	Our company seeks to reward a contract to an electronics company with expertise in creating a viable, stable, efficient and well designed guidance system for the Nike Amoke Rocket. The chosen vendor will assist in prototyping, testing, and evaluating the guidance system.
Start Date	07/04/2010
Expiration Date	04/03/2011
Status	Active
Company Website	www.yourcompany.com
DocPak Publisher	N/A
Organization	You Company Name
Address	201 N. Union Street Suite 140 Alexandria, VA 22314
Phone	703-740-1100
Fax	703-740-1101
Reply No Later Than	N/A

Figure 5.55: DocPak Table of Contents

5. Navigate through the DocPak as you would in the XE application. The images and attachments in the DocPak will open in an application associated with that type of file.

Download a DocPak Index

Note

The XE administrator must enable and configure this functionality so that a recipient of a DocPak may use this feature.

A DocPak Index contains all documents from a DocPak and any of its Line Items in the form of a spreadsheet. The spreadsheet contains the list of the document’s attributes including its revision and the original filename with which the document was imported into the XE repository.

You have two options to download the DocPak index:

- From the Received DocPaks page, mark the checkbox next to each DocPak you wish to download an index for. If you wish to download the index of all DocPaks displayed, click *Select All*. Click the *Download Index* link from the option bar. A file download dialog appears. Follow the steps listed in *Download a Document*.

Name	Description	Updated	Starts	Expires	Type	Status
<input type="checkbox"/> Ensuring Quality	QA/QC programs for project Horizon	01/11/2011	05/12/2010	05/11/2011		Active
<input type="checkbox"/> Focus Group Results	This DocPak contains the results of the focus group conducted in Boise, Idaho last week.	01/12/2011	01/11/2011			Active
<input type="checkbox"/> Introduction to DPXE	This DocPak contains the material and sample date from DigitalPaper's into course.	01/12/2011	08/22/2010		Training Material	Active
<input type="checkbox"/> New Marketing Material	This DocPak contains the latest versions of material that are now available from our website.	01/11/2011	01/11/2010			Active
<input type="checkbox"/> Project Horizon Collateral	This DocPak contains the latest set of marketing collateral for Project Horizon.	01/12/2011	06/22/2010		Marketing Literature	Active
<input type="checkbox"/> Project Horizon	The purpose of this DocPak is to communicate the design standards, conventions and idioms to be used in the design of the system.	01/12/2011	03/17/2010		Design Guidelines	Active
<input type="checkbox"/> Proposal 339.B1	Proposal to develop functionality extensions to Rotator Wing module.	01/11/2011	01/11/2010	05/17/2011		Active
<input checked="" type="checkbox"/> RFP 44692	Our company seeks to reward a contract to an electronics company with expertise in creating a viable, stable, efficient and well designed guidance system for the Nike Amoke Rocket. The chosen vendor will assist in prototyping, testing, and evaluating the guidance system.	01/12/2011	07/04/2010	04/03/2011	RFP	Active
<input type="checkbox"/> RFP 44692 - Complete	Our company seeks to reward a contract to an electronics company with expertise in creating a viable, stable, efficient and well designed guidance system for the Nike Amoke Rocket. The chosen vendor will assist in prototyping, testing, and evaluating the guidance system.	01/12/2011	07/04/2010	04/03/2011	RFP	Active
<input type="checkbox"/> RFQ 90-A13 DRAFT	Please review this final draft. Review should take no longer than 3 days.	01/12/2011	07/01/2010		RFQ	Active
<input type="checkbox"/> RFQ 90-A13 DRAFT No template		01/12/2011				Pending
<input type="checkbox"/> Rocket Schematics Update	This DocPak contains updated engineering drawings.	01/12/2011	02/01/2011	07/28/2011		Pending
<input type="checkbox"/> Seminars	This DocPak contains the documents that describe upcoming seminars, including schedule.	01/12/2011	08/01/2010		Company Programs	Active

Figure 5.56: Download one or more DocPak Indexes from the My DocPaks page

- Alternately, click the name of a DocPak on the main Received DocPaks page to display the contents of that DocPak, then click *Download Index* from the page bar. A file download dialog appears. Follow the steps listed in *Download a Document*.

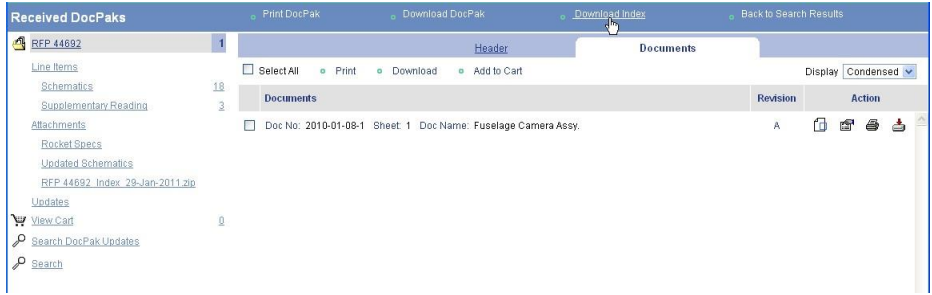

Figure 5.57: Download an individual DocPak Index

The DocPak is downloaded as a spreadsheet file containing a sheet structure where the main DocPak is a sheet and any Line Items that are present are individual sheets within the spreadsheet. The spreadsheet below represents the DocPak Index for a DocPak with two line items.

	A	B	C	D	E	F	G
1	DOCNO	SHEET	DOCNAME	Revision	FileName		
2	2010-01-08-1	1	Fuselage Camera Assy.	A	318661.tif		
3							
4							
5							
6							
7							
8							
9							
10							
11							
12							
13							
14							
15							
16							
17							
18							
19							
20							
21							
22							
23							
24							
25							
26							
27							
28							
29							
30							
31							
32							
33							
34							
35							
36							
37							
38							
39							
40							
41							
42							
43							
44							

Figure 5.58: DocPak Index Spreadsheet

Schedule DocPak Index Creation

Note
 The XE administrator must enable and configure the DocPak index and autocreate features before scheduled index creation may be configured.

This feature allows a DocPak creator to configure a DocPak to have its index created on a scheduled basis. (The schedule must be defined by the DigitalPaper XE administrator.) The DocPak Index will be added to the DocPak as an attachment.

To enable scheduled index creation, do the following:

1. From the DocPaks page that displays the contents of an individual DocPak, click the name of the DocPak link in the left pane. The DocPak header page is displayed.
2. Click the *Create DocPak Index Attachment* checkbox and then click the *Save* button.

My DocPaks | Print DocPak | Download DocPak | Download Index | Copy DocPak | Expire DocPak | Back to Search Results

RFP 44692 | 1 | Add documents to DocPak from: Cabinet | Cart

Header | Documents

*** Name** RFP 44692

Description Our company seeks to reward a contract to an electronics company with expertise in creating a viable, stable, efficient and

Start Date 07/04/2010

Expiration Date 04/03/2011 Never Expire

Status Active

Public

Change Notification Approve changes before notifying recipients Automatically notify recipients after a change has been made

Receive Email Notification for Publisher

Create DocPak Index Attachment

*** Company Website** www.yourcompany.com

DocPak Publisher

Organization You Company Name

Address 201 N. Union Street
Suite 140
Alexandria, VA 22314

*** Phone** 703-740-1100

Fax 703-740-1101

Reply No Later Than

Save **Reset**

Figure 5.59: Auto Create DocPak Index

Depending on how the XE administrator has configured the index creation schedule, the DocPak should contain an attachment that represents its index within 24 hours.

The creator and any recipient of the DocPak may download the DocPak Index attachment by clicking on the *Attachments* link in the left pane on the page that displays the contents of an individual DocPak. This will display a list of attachments. The DocPak Index's name will be in the form of **[DocPak Name]_Index_dd-mon-yyyy.zip**.

My DocPaks | Print DocPak | Download DocPak | Download Index | Copy DocPak | Expire DocPak | Back to Search Results

RFP 44692 | 1 | Select All | Download | Delete

Name	Description
<input type="checkbox"/> Rocket Specs	This attachment is a spreadsheet containing the specs for the rocket assembly.
<input type="checkbox"/> Updated Schematics	The attached spreadsheet contains updated schematics on some parts.
<input checked="" type="checkbox"/> RFP 44692_Index_18-Jan-2011.zip	DocPak Index file created on 18-Jan-2011

Figure 5.60: DocPak Index Attachment

Search for Documents within a DocPak

To search for documents within a DocPak:

1. From the DocPaks page that displays the contents of an individual DocPak, click the *Search* link in the left pane. The Search for Documents Within DocPak page is displayed.

Figure 5.61: DocPak Document Search

2. Enter your search criteria and click the *Search* button.

Note

The *Include Line Items in Search* checkbox may be checked if you want the search to include documents located in the Line Items of the DocPak. If the checkbox is not checked, the search results will contain documents from the top level DocPak only.

3. The Document Search Results are displayed in the right pane in condensed format.

Document Attributes	Revision	Action
<input type="checkbox"/> Doc No: 2009-11-25-1 Sheet: 1 Doc Name: Nike Smoke Assy.	C	[Icons]
<input type="checkbox"/> Doc No: 2009-11-30-1 Sheet: 1 Doc Name: Sentry Rocket Assy.	A	[Icons]
<input type="checkbox"/> Doc No: 2009-12-21-1 Sheet: 1 Doc Name: Nose Cone	A	[Icons]
<input type="checkbox"/> Doc No: 2010-01-08-1 Sheet: 1 Doc Name: Fuselage Camera Assy.	A	[Icons]
<input type="checkbox"/> Docn No (P/N): 25679 Doc Name: Med Screw Eye Model Type: Manufacturing Related Site: www.nikesmoke.com	A	[Icons]
<input type="checkbox"/> Docn No (P/N): 25681 Doc Name: Launch Lug Model Type: Manufacturing Related Site: www.nikesmoke.com	A	[Icons]
<input type="checkbox"/> Spreadsheet Name: Preliminary Figured Required Reading: Yes Created on: 03/28/2010	1	[Icons]
<input type="checkbox"/> Spreadsheet Name: Schedule Required Reading: Yes Created on: 03/28/2010	B	[Icons]
<input type="checkbox"/> Doc No: RFQ 90-A13 Sheet: 1 Doc Name: RFQ Draft	B	[Icons]

Figure 5.62: DocPak Document Search Results

Search for Documents within a Specific Line Item

If the XE administrator has enabled specific Line Item searches, the user will see a drop down list containing all the Line Items in the DocPak.

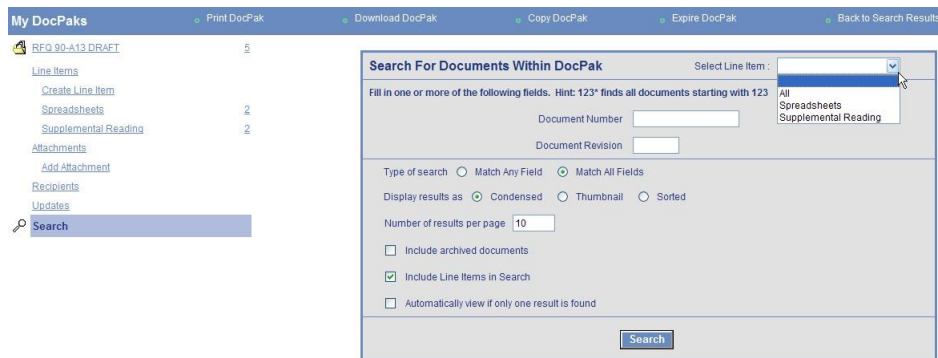

Figure 5.63: Specific Line Item Search

By selecting a specific Line Item from the drop down menu, the search will be performed on the selected Line Item and return documents matching the search criteria entered. The top level DocPak and all other Line Items will not be searched.

If *All* is selected then the search will be performed on all Line Items in the DocPak. The top level DocPak will not be searched for documents matching the search criteria.

If nothing is selected from the drop down menu, then the search will be performed on the top level DocPak. All Line Items will also be searched if the *Include Line Items in Search* checkbox is checked.

Search for DocPak Updates

If the XE administrator has enabled DocPak Update searches, a recipient of a DocPak may search all updates for the DocPak based on a date range that may be entered.

To search for DocPak updates,

1. Click the *Search DocPak Updates* link from the left pane of the DocPak page.
2. The *Search DocPak Updates* page appears.

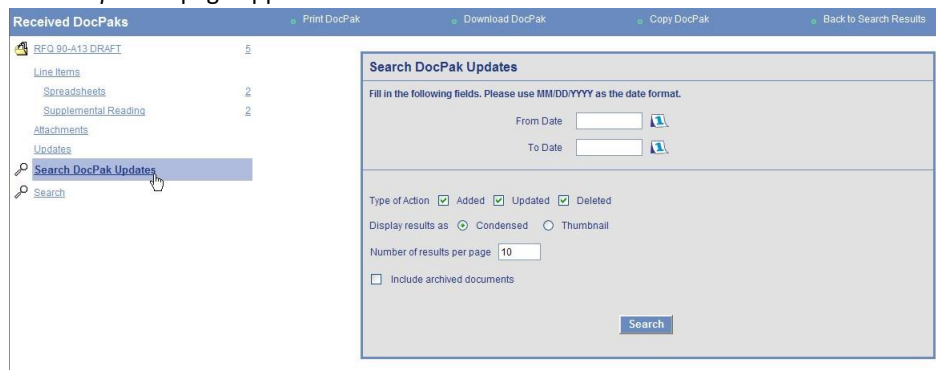

Figure 5.64: Search DocPak Updates

3. Enter a date range by filling in valid dates for the *To Date* and *From Date* text fields.
4. To return results of updates where documents have been added to and/or updated in the DocPak, select the *Added* and/or *Updated* checkboxes, respectively. (Updated documents are documents that have been replaced by a more current revision.) Similarly, to search for documents that have been removed from the DocPak, select the *Deleted* checkbox.
5. Click the *Search* button.

6. The condensed search results are displayed as shown in Figure 5.65.

Documents	Revision	Date Changed	Location	Operation	Action
<input type="checkbox"/> Doc No: RFQ 90-A13 Sheet: 1 Doc Name: RFQ Draft	A	01/12/2011	RFQ 90-A13 DRAFT	Removed via Update	
<input type="checkbox"/> Doc No: RFQ 90-A13 Sheet: 1 Doc Name: RFQ Draft	B	01/12/2011	RFQ 90-A13 DRAFT	Added via Update	
<input type="checkbox"/> Spreadsheet Name: Preliminary Figured Required Reading: Yes Created on: 03/28/2010	1	01/12/2011	Spreadsheets	Added	
<input type="checkbox"/> Spreadsheet Name: Schedule Required Reading: Yes Created on: 03/28/2010	B	01/12/2011	Spreadsheets	Added	
<input type="checkbox"/> Spreadsheet Name: Schedule Required Reading: Yes Created on: 03/28/2010	B	01/12/2011	Spreadsheets	Deleted	
<input type="checkbox"/> Spreadsheet Name: Preliminary Figured Required Reading: Yes Created on: 03/28/2010	1	01/12/2011	Spreadsheets	Deleted	
<input type="checkbox"/> Doc No: 2009-11-25-1 Sheet: 1 Doc Name: Nike Smoke Assy.	C	01/12/2011	Spreadsheets	Deleted	
<input type="checkbox"/> Doc No: 199 Sheet: 1 Doc Name: Schedule	A	01/12/2011	Spreadsheets	Deleted	
<input type="checkbox"/> Spreadsheet Name: Preliminary Figured Required Reading: Yes Created on: 03/28/2010	1	01/12/2011	Spreadsheets	Added	
<input type="checkbox"/> Spreadsheet Name: Schedule Required Reading: Yes Created on: 03/28/2010	B	01/12/2011	Spreadsheets	Added	

Figure 5.65: DocPak Update Search Results

Search for DocPaks

To search for DocPaks you have created, received, or are publicly available:

1. Click the *Search DocPaks* link from the page bar of the My DocPaks, Received DocPaks, or Public DocPaks main page. The Search DocPaks page appears.

Search Received DocPaks

Name

Description

Updated between and

Starts between and

Expires between and

Type

Status

Sort

Automatically view if only one result is found

Include Archived DocPaks

Figure 5.66: Search DocPaks

2. From the pull-down menu, select the type of DocPak for which you wish to search: My DocPaks, Received DocPaks, or Public DocPaks.
3. Enter your search criteria based on the DocPak's required attributes. For more information on the search criteria to enter in these fields, see *Search DocPaks Page*.

Note

Searches are not case-sensitive. You can only search on required DocPak attributes (i.e., name, description, effective date, expiration date, status, or type); custom attribute searches are not supported.

4. Click *Search*.

The DocPak search results page will display listing only the DocPaks that matched your search criteria.

Name ^	Description	Updated	Starts	Expires	Type	Status
<input type="checkbox"/> Ensuring Quality	QA/QC programs for project Horizon	01/11/2011	05/12/2010	05/11/2011		Active

Figure 5.67: Received DocPak Search Results page

Edit DocPaks

You can modify any DocPak you have created. While you cannot modify Received DocPaks or Public DocPaks, you may copy them and rename them to create a new DocPak.

Modify a Saved DocPak

To modify the contents of a DocPak or the DocPak's structure:

1. Click *DocPaks* from the navigation bar at the top of the window. (If the Received DocPaks page or Public DocPaks appears, click the *Show My DocPaks* link from the page bar.) The My DocPaks page displays.

Name ^	Description	Updated	Starts	Expires	Type	Status
<input type="checkbox"/> Focus Group Results		01/11/2011	01/11/2011			Active
<input type="checkbox"/> New Marketing Material	This DocPak contains the latest versions of material that are now available from our website.	01/11/2011	01/11/2010			Active
<input type="checkbox"/> Proposal 339.B1	Proposal to develop functionality extensions to Rotator Wing module.	01/11/2011	01/11/2010	05/17/2011		Active
<input type="checkbox"/> RFP 44692	Our company seeks to reward a contract to an electronics company with expertise in creating a viable, stable, efficient and	01/11/2011			RFP	Pending
<input type="checkbox"/> Rockets Schematics Update	Our company seeks to reward a contract to an electronics company with expertise in creating a viable, stable, efficient and	01/11/2011			RFP	Pending

Figure 5.68: My DocPaks displayed

2. Click the name of a DocPak on the main My DocPaks page to display the contents of that DocPak. Go to the sections below to perform specific modifications:
 - *Modifying DocPak or Line Item Header Information.*
 - *Expiring DocPaks.*
 - *Activating DocPaks.*
 - *Delete Documents from a DocPak or Line Item.*
 - *Delete a Line Item Folder.*
 - *Copy a DocPak.*

Modifying DocPak or Line Item Header Information

To modify DocPak or Line Item header information, do the following:

1. From the My DocPaks page of an individual DocPak, click the DocPak or Line Item name in the left pane to display the Header tab in the right pane.

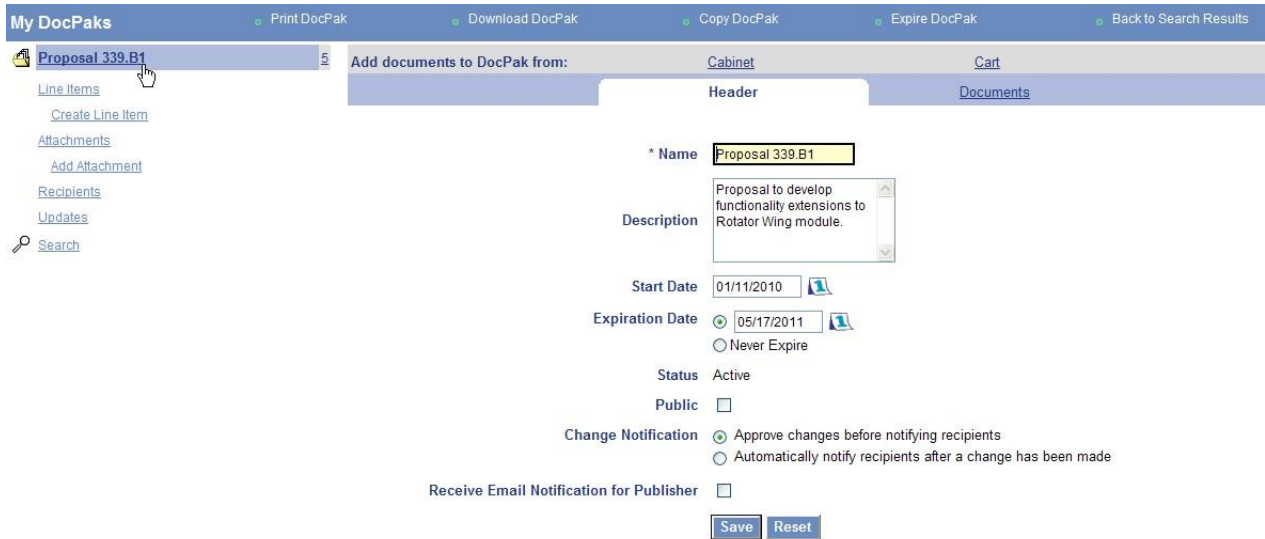

Figure 5.69: Click name to display Header tab

2. You can modify any field that appears in the form except Status (which is controlled by the Expiration Date that you set.)
3. Click *Save* to preserve your changes.

Note
DocPak recipients will not be sent an e-mail notification when Header information changes.

Expiring DocPaks

To immediately expire an active DocPak, do one of the following:

- From the My DocPaks page of an individual DocPak, click *Expire DocPak* from the page bar.

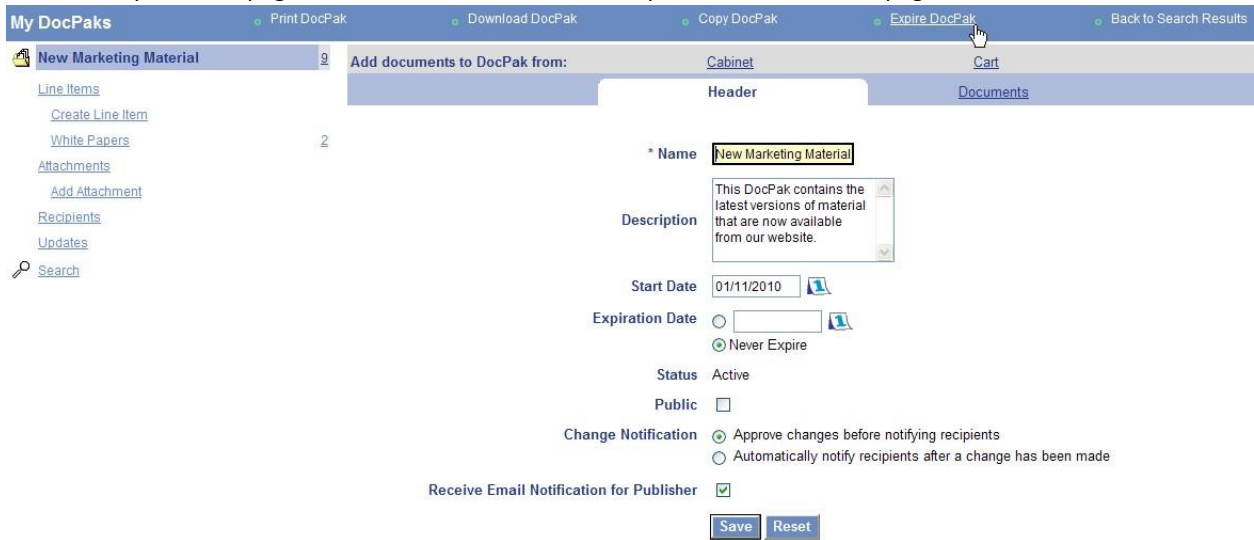

Figure 5.70: Expire an active DocPak

- Alternately, in the DocPak's Header tab, set the expiration date to the current date. Click *Save* to set the expiration date.

To verify that the DocPak has been expired, show *My DocPaks*. Notice that the expired DocPak is now displayed in red and that its status has been changed to "Expired."

Name ^	Description	Updated	Starts	Expires	Type	Status
<input type="checkbox"/> Focus Group Results		01/11/2011	01/11/2011			Active
<input type="checkbox"/> New Marketing Material	This DocPak contains the latest versions of material that are now available from our website.	01/11/2011	05/01/2010	05/12/2010		Expired
<input type="checkbox"/> RFP 44692	Our company seeks to reward a contract to an electronics company with expertise in creating a viable, stable, efficient and	01/11/2011			RFP	Pending
<input type="checkbox"/> Rockets Schematics Update	Our company seeks to reward a contract to an electronics company with expertise in creating a viable, stable, efficient and	01/11/2011			RFP	Pending

Figure 5.71: Expired DocPak listed in the main My DocPaks page

Since the DocPak is no longer active, DocPak recipients will no longer be able to view the DocPak in their Received DocPaks page.

Activating DocPaks

To activate a DocPak that is pending or reactivate an expired DocPak, do the following:

1. From the My DocPaks page of the individual DocPak, click *Activate DocPak* from the page bar.

My DocPaks | Print DocPak | Download DocPak | Copy DocPak | **Activate DocPak** | Back to Search Results

New Marketing Material | Add documents to DocPak from: Cabinet | Cart

Line Items | Create Line Item | White Papers | Attachments | Add Attachment | Recipients | Updates | Search

* Name: New Marketing Material

Description: This DocPak contains the latest versions of material that are now available from our website.

Start Date: 05/01/2011

Expiration Date: 05/12/2011 Never Expire

Status: Pending

Public:

Change Notification: Approve changes before notifying recipients Automatically notify recipients after a change has been made

Receive Email Notification for Publisher:

Save | Reset

Figure 5.72: Activate a DocPak

2. In the DocPak's Header tab, set the start date to the current date, and set the expiration date to a future date or to *never expire*. Click *Save* to save your changes.

DocPak recipients will be notified of the DocPak's availability via e-mail and they will have access to the DocPak's contents on the start date.

Delete Documents from a DocPak or Line Item

To delete documents from a DocPak or Line Item, do the following:

1. From the My DocPaks page of an individual DocPak, click the DocPak or Line Item name in the left pane to display the Header tab.
2. Click the *Documents* tab in the right pane to display the DocPak or Line Item's contents. Or, you can search for the document(s) you wish to remove by clicking the *Search* link in the left pane.

My DocPaks [Print DocPak](#) [Download DocPak](#) [Copy DocPak](#) [Activate DocPak](#) [Back to Search Results](#)

Add documents to Line Item from: [Cabinet](#) [Cart](#)

Line Items
[Create Line Item](#)
[White Papers](#) 2
[Attachments](#)
[Add Attachment](#)
[Recipients](#)
[Updates](#)
[Search](#)

Documents **Revision** **Action**

Documents	Revision	Action
<input type="checkbox"/> Title: Eliminating Friction Points Type: White Paper	1	Print Download Remove Share Refresh
<input checked="" type="checkbox"/> Title: Speed Buyer-Supplier Interaction Type: White Paper	2	Print Download Remove Share Refresh

Figure 5.73: Documents tab

3. Mark the checkbox next to each document to be deleted. If you wish to delete all documents, click the *Select All* checkbox.
4. Click the *Remove* link.
5. You will be prompted to confirm the removal. Click *OK* to remove the document(s) from the DocPak or Line Item.
6. If the DocPak is active, DocPak recipients will be notified of the deletion via e-mail.

Delete a Line Item Folder

To delete a Line Item folder, do the following:

1. Click the *Line Items* label in the left pane. A summary page of all Line Items stored in the DocPak appear.

My DocPaks [Print DocPak](#) [Download DocPak](#) [Copy DocPak](#) [Expire DocPak](#) [Back to Search Results](#)

Focus Group Results 3 **Select All** [Print](#) [Download](#) [Delete](#)

Line Items
[Create Line Item](#)
[Agenda](#) 1
[List of Questions](#) 1
[Slides](#) 2
[Subjective Results](#) 2
[Attachments](#)
[Add Attachment](#)
[Recipients](#)
[Updates](#)
[Search](#)

Name	Description	Document Count
<input type="checkbox"/> Agenda	Focus group agenda	1
<input type="checkbox"/> List of Questions	The list of questions posed to the focus group participants	1
<input type="checkbox"/> Slides	The slides used to facilitate the presentation	2
<input type="checkbox"/> Subjective Results	Contains the written and oral responses of the focus group participants	2

Figure 5.74: Line Items summary

2. Mark the checkbox next to each Line Item to be deleted. If you wish to delete all Line Items, click the *Select All* checkbox.
3. Click the *Delete* link in the option bar.

The screenshot shows the 'My DocPaks' interface. At the top, there are navigation links: 'Print DocPak', 'Download DocPak', 'Copy DocPak', 'Expire DocPak', and 'Back to Search Results'. Below this is a header for 'Focus Group Results' with a count of 3. A toolbar contains 'Select All', 'Print', 'Download', and 'Delete' buttons. A mouse cursor is pointing at the 'Delete' button. Below the toolbar is a table with columns: 'Name', 'Description', and 'Document Count'. The table lists four line items: 'Agenda' (checked), 'List of Questions', 'Slides', and 'Subjective Results'. On the left side, there are links for 'Create Line Item', 'Attachments', 'Add Attachment', 'Recipients', 'Updates', and 'Search'.

Line Items	Name	Description	Document Count
<input checked="" type="checkbox"/>	Agenda	Focus group agenda	1
<input type="checkbox"/>	List of Questions	The list of questions posed to the focus group participants	1
<input type="checkbox"/>	Slides	The slides used to facilitate the presentation	2
<input type="checkbox"/>	Subjective Results	Contains the written and oral responses of the focus group participants	2

Figure 5.75: Delete a selected Line Item folder

4. At the prompt, confirm that you wish to delete the selected Line Item(s) and the documents contained within the Line Item(s). Click *OK*.
5. If the DocPak is active and documents were stored within the deleted Line Item, DocPak recipients will be notified of the deletion via e-mail.

Copy a DocPak

To copy a DocPak in its entirety (except for DocPak recipients), do the following:

1. Click *DocPaks* from the navigation bar at the top of the window.
2. Navigate to the My DocPaks, Received DocPaks, or Public DocPaks page (as needed) by clicking either *Show My DocPaks*, *Show Received DocPaks*, or *Public DocPaks*.
3. Click the name of a DocPak on the main DocPaks page to display the contents of that DocPak.
4. Click *Copy DocPak* from the page bar.

My DocPaks Print DocPak Download DocPak **Copy DocPak** Activate DocPak Back to Search Results

RFP 44692 1 Add documents to DocPak from: Cabinet Cart

Line Items Header Documents

Create Line Item

Schematics 18

Supplementary Reading 3

Attachments

Add Attachment

Rocket Specs

Recipients

Updates

Search

* Name RFP 44692

Description Our company seeks to reward a contract to an electronics company with expertise in creating a viable, stable, efficient and

Start Date

Expiration Date Never Expire

Figure 5.76: Copy a DocPak

5. A copy of the DocPak is automatically created with the words "Copy of" prepended to the original DocPak name.

Add documents to DocPak from: Cabinet Cart

Header Documents

* Name Copy of RFP 44692

Description Our company seeks to reward a contract to an electronics company with expertise in creating a viable, stable, efficient and

Start Date

Expiration Date Never Expire

Figure 5.77: Copied DocPak

Note

Recipients are not copied during this process. You must add new recipients as described in *Specify DocPak Recipients*.

6. Modify the DocPak as described in *Modify a Saved DocPak*.
7. Click **Save**.

Delete an Entire DocPak

To delete a DocPak you have created, do the following:

1. Click *DocPaks* from the navigation bar at the top of the window (if the Received DocPaks or Public DocPaks page appears, click the *Show My DocPaks* link from the page bar).
2. Mark the checkbox next to each DocPak to be deleted. If you wish to delete all DocPaks, click the *Select All* checkbox.

- Click the *Delete* link in the option bar.

My DocPaks									
<input type="checkbox"/> Select All		<input type="radio"/> Print	<input type="radio"/> Download	<input type="radio"/> Delete	<input type="radio"/> Create DocPak			<input type="radio"/> Import DocPak	<input type="text"/> Search DocPaks
Name ^	Description	Updated	Starts	Expires	Type	Status			
<input type="checkbox"/> Focus Group results	This DocPak contains the results of the focus group conducted in Boise, Idaho last week.	05/13/2003	05/13/2003	07/25/2003		Active			
<input checked="" type="checkbox"/> New Marketing material	Contains the latest collateral available from the website.	05/13/2003	05/01/2003	05/12/2003	Marketing Literature	Expired			
<input type="checkbox"/> Proposal 339.B1	Proposal to develop functional extensions to the Rotor Wing module.	05/13/2003	06/06/2003	08/29/2003	Request for Proposal	Pending			
<input type="checkbox"/> RFP 44692	Our company seeks to reward a contract to an electronics company with expertise in creating a viable, stable, efficient and well-designed guidance system for the NKE Smoke Rocket. The chosen vendor will assist in prototyping, testing, and evaluating the guidance system.	05/13/2003	05/13/2003			Active			
<input type="checkbox"/> Rocket Schematics Update	This DocPak contains updated engineering drawings.	05/13/2003	06/24/2003	07/28/2003		Pending			
<input type="checkbox"/> Work Order 443-A	Draft work order for custom mapper application	05/13/2003			Sales	Pending			

Figure 5.78: Delete a DocPak

- You will be asked to confirm your deletion of the DocPak(s). Click *OK*.
- The DocPak will be removed from the My DocPaks page. If the DocPak was active, the DocPak will no longer be available from the recipient's Received DocPaks or Public DocPaks page.

Note

DocPak recipients will not be notified of the deletion via e-mail.



Part III

Reference

Chapter 6

Document Tools

This chapter consists of the sections listed below that describe the tools available to search, view, mark up, print and download documents that reside in the DigitalPaper XE system:

- *Document Search Tools.*
- *Document Viewer.*
- *Annotation Tools (ViewMark).*
- *Document Properties.*

Document Search Tools

This section describes the search options for performing document searches, as well as the interfaces used to search for documents and view search results. For more information:

- *Search for Documents Page.*
- *Search Options.*
- *Document Search Results Page.*

Search for Documents Page

The Search for Documents page, available by selecting *Documents* from the Navigation bar, lets you execute both general and specific searches of documents, with restricted searching based on the level of security set for the cabinets in which the documents are referenced. With the exception of search criteria, the display options you select when conducting a search are retained for the remainder of the session.

POWERED BY **eDigitalPaper XE** EXTENDED ENTERPRISE

Home Admin Indexing DocPaks BOMs **Documents** Options Help Logout

POWERED BY **eDigitalPaper**

Search For Documents Select Cabinet: All

Fill in one or more of the following fields. Hint: 123* finds all documents starting with 123

Document Number

Document Revision

Release Date

Cross DocPak search Yes No

Type of search Match Any Field Match All Fields

Display results as Condensed Thumbnail Sorted

Number of results per page

Include archived documents

Automatically view if only one result is found

Figure 6.1: Search for Documents example

Note

The Search for Documents page may appear different than the screen above. During DigitalPaper XE site configuration, this page may be modified to reflect a particular set of search requirements.

Search criteria you may specify will typically include:

- **Search Cabinet** – Use the pulldown menu to select either “All” cabinets to perform cross-cabinet searching of documents or select a specific cabinet to narrow the search.
- **Search Criteria** – When conducting a document search, you are searching based upon a subset of document attributes defined when the document was indexed into the system. The search criteria options may vary based upon your company’s custom search requirements. Search criteria entered in each text field are not case-sensitive. Sample search criteria may include:
 - *Document Name* – Search for one or more documents names as assigned when entered into the DigitalPaper XE repository through use of table lookups and wild card searching.
 - *Document Number* or *Doc No* – Search for one or more documents by its document number, as assigned when it was entered into the DigitalPaper XE repository.
 - *Sheet* – A page object that contains specific attributes about that page.
 - *Revision* – Search by a document’s revision label, if applicable by entering the exact label or * to search for all revisions. Sample revision labels include, but are not limited to:
 - * Pure numeric revision levels (e.g., 1, 2, 3)
 - * Pure alpha revision levels (e.g., A, B, C)
 - * Mixed numeric and alpha revision levels (e.g., 2, A1, A2, B or R001-A, R002-B, R002-C, R009-D).
 If this option is not available or you choose not to search by revision label, all documents returned will be the latest revision.
 - *Date Range* – Perform a search based on a date range of an attribute that has been configured as a date. * Expiration Date Range: 01/01/2011-01/31/2011
 - *Release Date* – Perform a search based on the date a document was released into the system.

You can utilize a set of search operators when searching for values in these fields as described in *Search Options*.

- **Type of search** – Specify the type of search to perform:
 - *Match All Fields* – Search results are returned based on the exact information as entered in each text field. For example, if you entered "phone" in the Document Name field, those documents with the name "telephone" would not be displayed, regardless of the other attribute fields. To correct this case, utilize the wildcard (*) as described in *Search Options*.
 - *Match Any Field* – Return documents that match at least one text attribute field.
- **Display results as** – Specify the way results should be displayed:
 - *Thumbnail* – Displays search results with a miniature preview of the first page of the document as well as the document’s attributes. If the documents found are not supported by the Viewer, the thumbnail will consist of an icon associated with the file’s MIME type.
 - *Condensed* – Displays the document’s attributes without a preview image of the document. This option is set as the default when the DigitalPaper XE product is shipped, although this setting may be customized by your system administrator.
 - *Sorted* – Displays the results list sorted in a tabular format. The columns that are displayed depend on how it is configured by the XE administrator.

Note

If you are searching for a large number of documents, the *Condensed* option offers the best performance.

- *Number of results per page* – The number of documents to be displayed in each page as described in *Document Search Results Page*.
- *Include archived documents* – Displays all versions of the same document.
- *Automatically view if only one document is found* – Bypasses the document search results page and automatically displays the document's contents in the *Document Viewer* (or prompts you to download the file if the file type is not supported by the Viewer).
- *Cross DocPak Search* – If the XE administrator has this feature enabled, it allows Enterprise Users to search for documents within DocPaks that they have created, for which they are a recipient, and that are public. The search results will display an extra column that has a drop down list of DocPaks where the document resides. The user may click on an item in the drop down list to be taken to that DocPak.

Search Options

DigitalPaper XE's powerful search engine lets you search for all documents stored in the entire repository, refine your search by specifying a simple word, phrase, or number applicable to one or more of the document's attributes, or expand your search query by using wild-card characters and operators listed in the table below.

Search Option	Description	Example
Full text	Search is conducted on the exact description entered.	Document Name: Interface Cabling Diagram Returns all documents with the document name: "Interface Cabling Diagram".
*	Search to match zero, one, or more characters.	Document Name: *ing Returns documents with the following in the title: "Stamping", "Printing", "Cabling" or "Manufacturing"
?	Search to match any one character.	Document Name: ?ing Returns documents with the following in the title: "Ring" or "King"
	Separate items in an OR search.	Document No: 111 222 333* Returns documents numbered 111 or 222 or 333, 3331, 3332, 33345, etc.
>	Search for values that are greater than the number entered.	Document No: > 111 Returns all documents numbered 112 or greater (e.g., 112, 113, 114) alpha characters cannot use this operator.
<	Search for values that are less than the number entered.	Document No: < 111 Returns all documents numbered 110 or less (e.g., 107, 108, 109 110) alpha characters cannot use this operator.
=>	Search for values that are greater than or equal to the number entered.	Document No: => 1 Returns all documents with a numeric label of 1 or greater (e.g., 1, 2, 3, 4) alpha characters cannot use this operator.

<=	Search for values that are less than or equal to the number entered	Document No: <= 3 Returns all documents with a numeric label of 3 or less (e.g., 1, 2, 3) alpha characters cannot use this operator.
-	Search for a range of values.	Document No: 100 - 500 Returns documents 100 through 500. If searching for a field that utilizes a numbering schema based on the varchar database type, and that numbering schema utilizes dashes (e.g., document number C5N-2-4566), you will not be able to search for ranges within that field.

Document Search Results Page

Once a search has been executed, you can view each indexed document that matches your search query in the Document Search Results page. Results are displayed in condensed view or with a thumbnail sketch as shown in the following figures.

The screenshot shows the 'Document Search Results [51 found]' page. At the top, there are navigation options: 'New Search' and 'View Cart (0)'. Below the header, there are action buttons: 'Select All', 'Print', 'Download', 'Add to Cart', and 'Delete'. A 'Display' dropdown menu is set to 'Thumbnail'. The main content area displays five search results, each with a thumbnail image, a list of actions (View, Properties, Print, Download), and a list of document properties:

- Result 1:** Revision: D, Doc No (P/N): 25670, Doc Name: NKE Smoke Assembly, Model: NKE Smoke, Model Type: Manufacturing, Related Site: www.nkesmoke.com, Sheet: 1
- Result 2:** Revision: A, Doc No (P/N): 25671, Doc Name: BT60 Body Tube, Model Type: Manufacturing, Related Site: www.nkesmoke.com
- Result 3:** Revision: A, Doc No (P/N): 25675, Doc Name: Engine Hook, Model Type: Manufacturing, Related Site: www.nkesmoke.com
- Result 4:** Revision: A, Doc No (P/N): 25676, Doc Name: Decal (United States), Model Type: Manufacturing, Related Site: www.nkesmoke.com
- Result 5:** Revision: A, Doc No (P/N): 25677, Doc Name: Decal (Access Panel), Model Type: Manufacturing, Related Site: www.nkesmoke.com

Figure 6.2: Document Search Results (Thumbnail)

Document Search Results Page Bar

The Document Search Results page bar lists the page title, the number of documents found, the number of seconds it took to find the documents listed (if the XE administrator turns on the functionality). It also provides the following functions:

- **New Search** – Click *New Search* to begin a new search.
- **View Cart** - Click *View Cart* to view the contents of your document cart. For more information about the cart, see *Document Cart*.

Search Results Option Bar





The Search Results option bar allows you to select or deselect documents displayed and perform functions on selected documents, as follows:

- *Select All* – Selects or deselects all documents on the Search Results page.
- *Print* – Displays options to print selected documents. For more information, see *Printer Options Page*.
- *Download* – Downloads the selected document(s) to locally-accessible storage. For more information see *Download a Document*.
- *Add to Cart* – Allows the user to group documents into a cart for downloading and printing. See *Document Cart* for more information.
- *Display* – Select to display the Search Results page with a thumbnail sketch (*Thumbnail*) of the document and its attributes, with only the documents' attributes (*Condensed*) or sorted in a tabular format (*Sorted*).

Search Results Content Area

The Search Results content area lists all documents found and a subset of each document's attributes (the number of attributes displayed is configured by the system administrator). For each document you can perform an action such as view the document, view all document properties, print the document, or download the document:

Action Items The Search Results content area contains the following action items:

- *Select box* – Select documents individually for the purpose of printing or downloading.
- *View* – Click the View icon , link, or thumbnail image (if displayed) to open a document with DigitalPaper XE's *Document Viewer* as described. If the document is not supported by the Viewer, you will be prompted to download the document to your computer.
- *Properties* – Displays all attributes associated with a document, and allows you to view, print, or download the document, as well as view its revision history and saved ViewMarks, if any. For more information, please see *Document Properties*. 
- *Print* – Displays printer options. For more information, see *Printer Options Page*. 
- *Download* – Downloads the selected document(s) to locally-accessible storage. For more information see *Download a Document*. 
- *Where Used* – If Bill of Materials functionality is enabled and a document is a part of a Bill of Materials, the *Where Used* icon  will be displayed. Clicking the *Where Used* icon will bring the user to the Bill of Materials and navigate down to the Part where the document is used.

Sort Documents The search results content area allows you to sort the documents based on a document attribute. The attribute name is a hyperlink and clicking on it will sort the documents in ascending or descending order. The arrow preceding the attribute name indicates the direction of sorting.

Note

During the DigitalPaper XE site configuration, the attributes that may be sorted in the search results display are configured by the system administrator.

Document Cart

The Document Cart allows an Enterprise User to group documents into a common area. The documents may be from more than one cabinet depending on the user's access permissions. The cart is useful to group documents that a user frequently needs. These documents may be viewed, printed and downloaded.

See *Document Cart* for more details.

Document Viewer

DigitalPaper XE's Viewer tool lets you display and navigate through documents that were imported as BMP, GIF, JPEG, or PNG types or formats, as well as files that have been converted to TIFF or DPCI during the import process. You can view documents of any size, print and download displayed documents, and annotate and e-mail the marked up copy to other Enterprise Users and Trading Partners (as discussed in *Annotation Tools (ViewMark)*).

For detailed information about how to use the Viewer Tools see *Viewer Tools*.

Annotation Tools (ViewMark)

With the ViewMark feature, you can overlay rectangles, circles, arrows, text and highlight annotations onto a document, then share these annotations via e-mail with other Enterprise Users and Trading Partners for the purpose of collaboration.

For detailed information about how to use the Annotation Tools see *Annotation Tools*.

Document Properties

Regardless of display type, only a limited number (as configured by the system administrator) of a document's attributes can be displayed in each Search Results page. To view the complete set of attributes associated with a document, click the Properties icon or link within the Search Results page to display the document's properties.



See *View Document Properties* for more information.

Chapter 7

Bill of Materials

This chapter consists of the sections listed below that describe how to use the Bill of Materials interface:

- *Bill of Materials Interface.*
- *Search for Bills of Materials.*
- *Print a Bill of Materials.*
- *Download a Bill of Materials.*
- *Searching for Documents Within a Bill of Materials.*
- *Bill of Materials Toolbar Tasks.*
- *Using the “Where Used” Icon.*

Bill of Materials Features

DigitalPaper XE supports the importing of a Bill of Materials (BOM) part structure and provides a hierarchical tree representation of the structure and the ability to link the part structure to documents contained within the repository. A BOM or sub-assembly sections of a BOM can be exported to DocPaks and the documents contained in a BOM can be printed and downloaded.

After a document has been associated with a part in a BOM, an icon appears with that document that will link to the BOM interface, providing a “where used” search capability.

As with DocPaks, a full range of search options are provided to quickly locate a particular BOM, or to locate documents within a BOM.

The Bill of Materials Interface

When the Bill of Materials feature is activated, a *BOMs* menu item is added to the main menu bar. Clicking the link results in a search results page showing all BOMs currently loaded in the system.

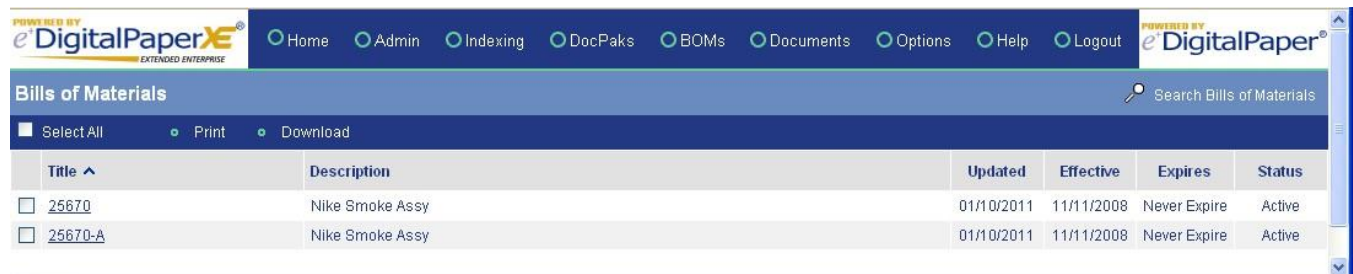

Title ^	Description	Updated	Effective	Expires	Status
<input type="checkbox"/> 25670	Nike Smoke Assy	01/10/2011	11/11/2008	Never Expire	Active
<input type="checkbox"/> 25670-A	Nike Smoke Assy	01/10/2011	11/11/2008	Never Expire	Active

Figure 7.1: Bill of Materials Main Page

As with other pages in DigitalPaper XE, selecting the checkbox next to a BOM Title enables the items on the Options Bar for that BOM. The following sections describe the actions that can be performed from this page.

Search for Bills of Materials

Clicking the *Search Bills of Materials* link generates a search criteria input page.

Figure 7.2: Search Bill of Materials

This page allows a search for existing BOMs using any of the criteria on the form as follows:

- *Bill of Materials Title* – the title of the BOM.
- *Bill of Materials Description* – the BOM description.
- *Part Name* – the part name.
- *Part Description* – the part description.

Note

If the *Part Name* or *Part Description* fields are used, the search will return any BOM containing the specified part.

Note

Depending on the configuration, the *Part Description* may not appear in the BOM tree display.

- *Status* - select the status to use in the search - *All*, *Pending*, *Active*, *Expired* or *Archived*.
- *Updated between* – return only those BOMs that have been updated between the dates specified.
- *Effective between* – return only those BOMs that are effective between the dates specified.
- *Expires between* – return only those BOMs that expire between the dates specified.

Note

If *Expired* or *Effective* are chosen, the date ranges specified in the corresponding input fields will be used to specify the search date range.

- *Current as of Date* – return only those BOMs that are current as of the date specified.

The form also allows the user to select how the results will be *Sorted* (by *Title*, *Description*, *Date*, or *Status*) and how to order the results (*Ascending* or *Descending*.)

Print a Bill of Materials

The *Print* link on the Options Bar will print all the documents contained within the selected BOMs. The BOM can also be printed from links in the BOM view.

Download a Bill of Materials

The *Download* link will generate a zip file containing all documents within the selected BOMs. If there are subassemblies in the BOM, a directory structure will be created in the zip file for each part that contains child parts, as pictured in the following figure. The BOM can also be downloaded from the BOM view as described.

Note

The documents are downloaded with their original filenames.

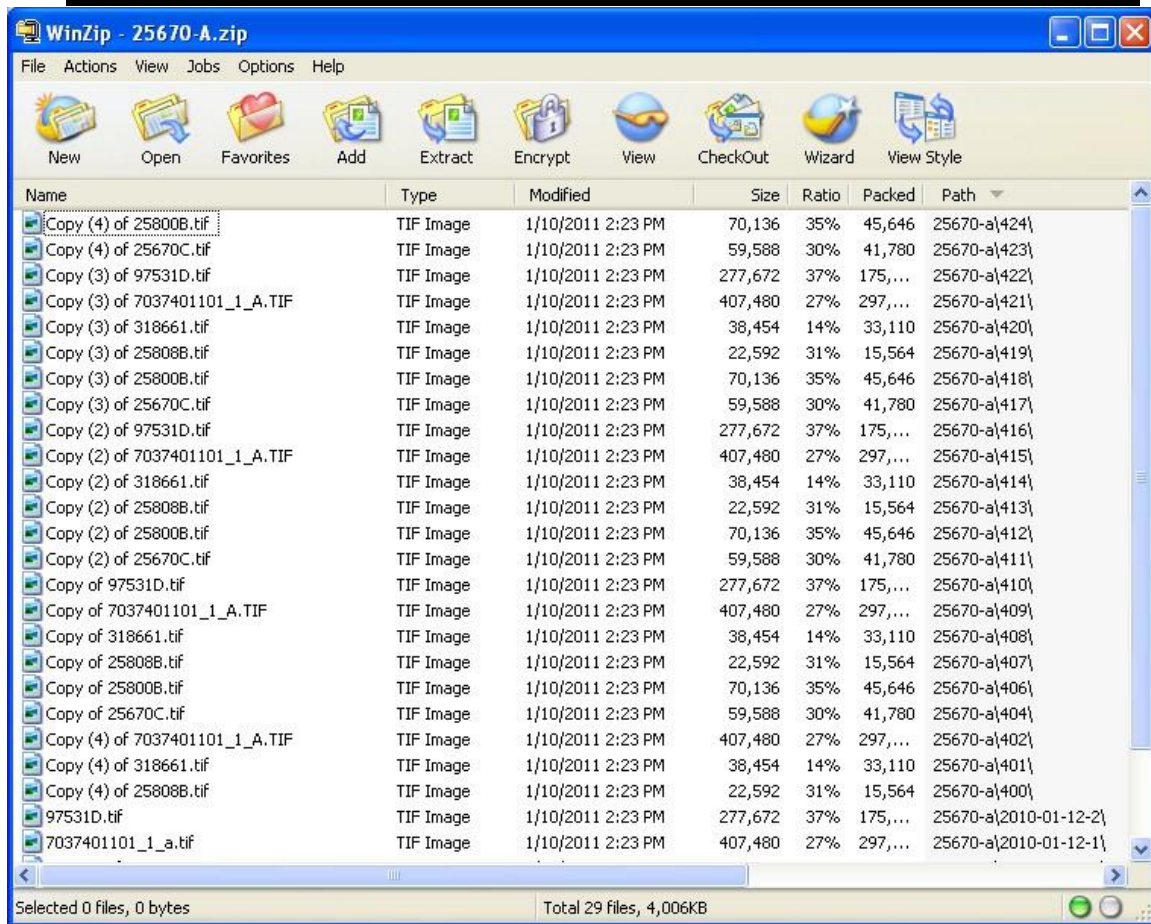

Figure 7.3: BOM Download Zip file

View a Bill of Materials

Clicking on the name of a BOM opens the Bill of Materials view.

Documents	Revision	Action
<input type="checkbox"/> Doc No: 2009-11-25-1 Sheet: 1 Doc Name: Nike Smoke Assy.	C	[Print] [Download] [Copy]
<input type="checkbox"/> Doc No: 2009-11-30-1 Sheet: 1 Doc Name: Sentry Rocket Assy.	A	[Print] [Download] [Copy]
<input type="checkbox"/> Doc No: 2009-12-21-1 Sheet: 1 Doc Name: Nose Cone	A	[Print] [Download] [Copy]
<input type="checkbox"/> Doc No: 2010-01-08-1 Sheet: 1 Doc Name: Fuselage Camera Assy.	A	[Print] [Download] [Copy]
<input type="checkbox"/> Doc No: 2010-01-12-1 Sheet: 1 Doc Name: Spring Assy.	A	[Print] [Download] [Copy]
<input type="checkbox"/> Doc No: 2010-01-12-2 Sheet: 1 Doc Name: Rotator Slip Ring	A	[Print] [Download] [Copy]
<input type="checkbox"/> Doc No: 404 Sheet: 1 Doc Name: Nike Smoke Assy.	B	[Print] [Download] [Copy]
<input type="checkbox"/> Doc No: 406 Sheet: 1 Doc Name: Sentry Rocket Assy.	B	[Print] [Download] [Copy]
<input type="checkbox"/> Doc No: 407 Sheet: 1 Doc Name: Nose Cone	B	[Print] [Download] [Copy]

Figure 7.4: Bill of Materials View

From this view you may print, download, or copy the BOM in addition to viewing the BOM properties, documents within the BOM, and the structure of the BOM as described in the following sections.

Page Bar Tasks

Print Bill of Materials

Click *Print Bill of Materials* from the Page Bar to print the documents associated with the BOM.

Download Bill of Materials

Click *Download Bill of Materials* from the Page Bar to download the documents associated with the BOM.

Copy Bill of Materials

Click *Copy Bill of Materials* from the Page Bar to create a new BOM with all the same properties and attributes as this BOM.

Note:

The new BOM will have the same name as the original BOM with the string “Copy of “ prepended to the name.

Back to Search Results

Click *Back to Search Results* to return to the previous search results page.

Note:

To clear any search criteria and return to all BOMs, click the *BOMs* link from the main menu.

Bill of Materials Navigator

The left portion of the Bill of Materials view page displays the BOM navigator. Here, the BOM properties can be viewed and different combinations of documents can be selected to view in the right side of the page. The parts in the BOM are represented in a tree structure of nodes and branches that can be expanded and collapsed by clicking the + and – symbols in the tree list.

Show Bill of Materials Properties

Click *Show Bill of Materials Properties* to view the BOM properties. A pop-up window will open showing the BOM header information.



Figure 7.5: BOM Properties

Show All Parts

Click the *Show All Parts* link will display a list of all documents in the BOM in the search results panel in the right side of the browser.

Navigate a Bill of Materials

The tree view of the BOM has a link for each part in the BOM, arranged hierarchically with branches for subassemblies. Clicking a part number will display the associated document(s) in the search results panel in the right side of the browser.

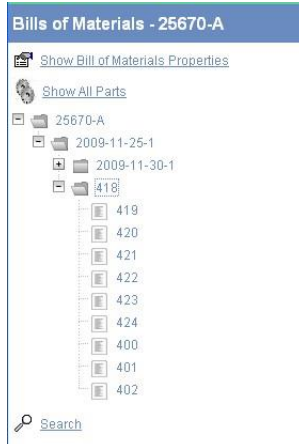

Figure 7.6: Bill of Materials Navigation

Right Click Context Menu

Right-clicking on a part number brings up a context menu as shown in the following figure.

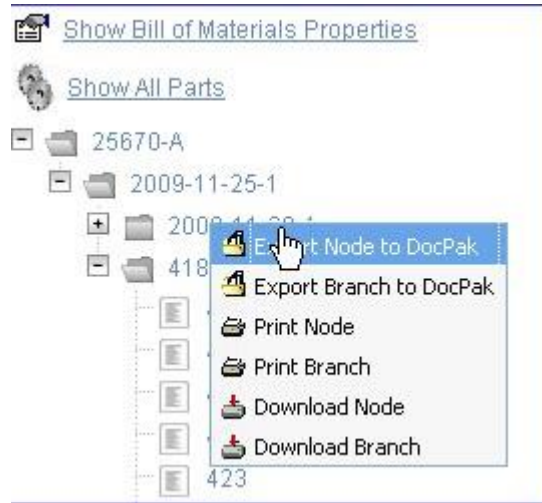

Figure 7.7: Right Click Context Menu

The options available from this menu are:

- *Export Node to DocPak* – Create a DocPak whose contents consist of the single document at that node.
- *Export Branch to DocPak* – Create a DocPak whose contents consist of the single document at that node plus all documents within the branch that extends from the node.
- *Print Node* – Print the single document at that node.
- *Print Branch* – Print the single document at that node plus all documents within the branch that extends from the node.
- *Download Node* – Download the single document at that node. The document will be contained in a Zip file whose structure reflects the structure of the BOM.
- *Download Branch* – Download the single document at that node plus all documents within the branch that extends from the node. The documents will be contained in a Zip file whose structure reflects the structure of the BOM.

Searching for documents within a Bill of Materials

When the [Search](#) link is clicked, the standard document search interface appears in the right side of the browser. The user may then enter criteria to search for documents associated with parts contained in the BOM.

After entering the search criteria, click the *Search* button. The standard document search results list will be displayed.

Note

See *Working with Documents* for more information on the standard document search interface and the standard document search results list.

Search For Parts Within Bill of Materials

Fill in one or more of the following fields. Hint: 123' finds all documents starting with 123

Document Number

Document Revision

Document Name

Sheet Number

Type of search Match Any Field Match All Fields

Display results as Condensed Thumbnail Sorted

Number of results per page

Include archived documents

Automatically view if only one result is found

Search

Figure 7.8: Search Screen

Bill of Materials Options Bar Tasks

The BOM options bar provides menu-based access to various functions commonly performed on documents within a BOM.



Figure 7.9: Bill of Materials Options Bar

The functions available from the menu are:

- *Select All* – Selects or deselects all documents on the results page.
- *Print* – Displays options to print selected documents. For more information, see *Printer Options Page*.
- *Download* – Downloads the selected document(s) to locally-accessible storage. For more information see *Download a Document*.

The following commands appear only when a node with child parts below it has been selected in the tree display. They function as they do in the context menu described in *Right Click Context Menu*.

- *Export Node to DocPak* – Create a DocPak whose contents consist of the single document at that node.
- *Export Branch to DocPak* – Create a DocPak whose contents consist of the single document at that node plus all documents within the branch that extends from the node.
- *Print Node* – Print the single document at that node.
- *Print Branch* – Print the single document at that node plus all documents within the branch that extends from the node.

Where Used Search Icon

When the Bill of Materials feature has been activated and a document is associated with a part in a BOM, a  [Where Used](#) link will appear with the document when it is returned as part of a document search result set.

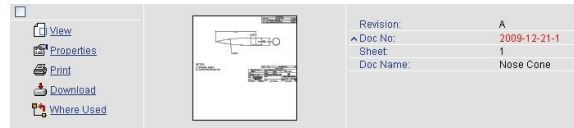

Figure 7.10: Where Used Link

When clicked, the user will be presented with the main BOM interface showing a list of BOMs containing that document.

Chapter 8

DocPak Tools

A DocPak is a logical representation that references the physical store of documents in one or more cabinets. This chapter consists of the sections listed below that describe the tools available to view DocPaks you have created, how to create DocPaks and search for them, as well as view DocPaks you have received from other Enterprise Users, as described in the following sections:

- *My DocPaks Tools.*
- *Received DocPaks Pages.*
- *Public DocPaks Pages.*
- *Create DocPak and Line Items Tools.*
- *Import DocPak Pages.*
- *Search DocPaks Page.*
- *Download a DocPak Index.*

My DocPaks Tools

This section describes the interfaces associated with viewing DocPaks you have created.

My DocPaks Main Page

The My DocPaks page that lists all DocPaks you have created is displayed by default when the *DocPaks* link at the top of each page is selected or when the *My DocPaks* link is selected from the Received DocPaks or Public DocPaks option bar. The My DocPaks page lists all DocPaks created by the Enterprise User.

My DocPaks							
		Show Received DocPaks	Show Public DocPaks	Create DocPak	Import DocPak	Search DocPaks	
<input type="checkbox"/> Select All Print Download Delete							
Name ^	Description	Updated	Starts	Expires	Type	Status	
<input type="checkbox"/> Focus Group results	This DocPak contains the results of the focus group conducted in Boise, Idaho last week.	05/13/2003	05/13/2003	07/25/2003		Active	
<input type="checkbox"/> New Marketing material	Contains the latest collateral available from the website.	05/13/2003	05/01/2003		Marketing Literature	Active	
<input type="checkbox"/> Proposal 339.B1	Proposal to develop functional extensions to the Rotor Wing module.	06/19/2003	06/06/2003	08/29/2003	Request for Proposal	Pending	
<input type="checkbox"/> RFP 44692	Our company seeks to reward a contract to an electronics company with expertise in creating a viable, stable, efficient and well-designed guidance system for the NKE Smoke Rocket. The chosen vendor will assist in prototyping, testing, and evaluating the guidance system.	05/13/2003	05/13/2003			Active	
<input type="checkbox"/> Rocket Schematics Update	This DocPak contains updated engineering drawings.	06/23/2003	06/24/2003	07/28/2003		Pending	
<input type="checkbox"/> Work Order 443-A	Draft work order for custom mapper application	05/13/2003			Sales	Pending	

Figure 8.1: My DocPaks page

My DocPaks Page Bar

When viewing all DocPaks you have created, the My DocPaks page bar allows you navigate to the DocPaks you have received from other Enterprise Users, create a new DocPak, or search the repository for DocPaks created by all Enterprise Users. It contains the menu options:

- *Show Received DocPaks* – Opens the Received DocPaks page. For more information, please see *Received DocPaks Pages*.
- *Show Public DocPaks* – Opens the Public DocPaks page. For more information, please see *Public DocPaks Pages*.
- *Create DocPak* – Displays the Create New DocPak page. For more information, please see *Create DocPak and Line Items Tools*.
- *Import DocPak* – Displays the Import DocPak page. For more information, please see *Import DocPak Pages*.
- *Search DocPaks* – Allows you to search for all DocPaks in the repository. For more information, please see *Search DocPaks*.

My DocPaks Option Bar

The My DocPaks option bar provides a way to select all the DocPaks listed on the page, as well as print and download the contents of selected DocPaks. It contains the menu options:

- *Select All* – Clicking an empty *Select All* checkbox marks the checkboxes for all DocPaks displayed. This feature is used to select all DocPaks for the purpose of printing, downloading, or deletion. Clicking a marked *Select All* checkbox clears the checkboxes for all DocPaks displayed.
- *Print* – Displays printer options. You can send one or more selected DocPaks directly to a printer. All associated documents are printed. For more information, see *Printer Options Page*.
- *Download* – Downloads the document(s) within the selected DocPaks to the client computer. All associated documents are downloaded. DocPaks are downloaded as a Zip file containing a directory structure identical to that displayed in the DocPaks page.
- *Download Index* – If the XE administrator has this feature enabled, you will see this link. A DocPak Index contains all documents from a DocPak and any of its Line Items in the form of a spreadsheet. The spreadsheet contains the list of the document's attributes including Revision and the original Filename with which the document was imported into the XE repository. For more information, see *Download a DocPak Index*.
- *Delete* – Permanently removes the selected DocPak(s) from the My DocPaks page. Recipients of a deleted DocPak will be notified via e-mail of the deletion and will no longer be able to view the DocPak contents in their Received DocPaks page.

My DocPaks Content Area

For each DocPak you have defined, the content area displays the information specified in the Create DocPak page. The columns within the content area are as follows:

- *Name* – Contains the name of each DocPak. Click a name link to display the contents of the DocPak as described in *My DocPaks (Single DocPak)*.
- *Description* – A text description of the DocPak.
- *Updated* – The date that the contents of the DocPak were last updated (e.g., a document was replaced with a new version). Click the link to display the My DocPaks Updates page for the selected DocPak.
- *Starts* – The date that the contents of the DocPak can be viewed by DocPak recipients. If no start date has been set, this field will be blank and the DocPak status field will be set to "Pending".

- Expires – The expiration date for the DocPak. The date format is determined during DigitalPaper XE configuration. If a cell in this column is blank, no expiration date has been set.

Note

Depending on how the system was configured, an expired DocPak will be archived after a certain number of days and can no longer be viewed from the content area.

- Type – Template used to create the DocPak. For example: General, RFP, RFQ, Work Order. If this cell is blank, no template was used during the DocPak creation process. For more information, see *Create DocPak and Line Items Tools*.
- Status – Indicates whether or not a DocPak is:
 - Pending – The DocPak cannot be viewed because the effective date has not been set or the effective date occurs in the future.
 - Active – The DocPak’s contents can be viewed by DocPak recipients.
 - Expired – The DocPak’s expiration date has passed. The DocPak’s contents can no longer be accessed by DocPak recipients.

Column Sorting

The up/down arrow graphic (for example, ) within the column header indicates the column that controls the sorting of the DocPaks as well as whether or not the order is ascending or descending. To select a column to sort on, click the column header link; to change the order from ascending to descending (or vice versa), click the column header again.

My DocPaks (Single DocPak)

To view, modify, or publish the contents of a single DocPak, click the name of the DocPak from the Name column as described in *My DocPaks Main Page*. The My DocPaks page for the selected DocPak will appear.

My DocPaks Print DocPak Download DocPak Copy DocPak Expire DocPak Back to Search Results

RFP 44692 Add documents to DocPak from: Cabinet Cart

Line Items Header Documents

Create Line Item

Attachments Add Attachment

Recipients

Updates

Search

* Name: RFP 44692

Description: Our company seeks to reward a contract to an electronics company with expertise in creating a viable, stable, efficient and

Start Date: 07/04/2010

Expiration Date: 04/03/2011 Never Expire

Status: Active

Public:

Change Notification: Approve changes before notifying recipients Automatically notify recipients after a change has been made

Receive Email Notification for Publisher:

* Company Website: www.yourcompany.com

DocPak Publisher:

Organization: You Company Name

Address: 201 N. Union Street
Suite 140
Alexandria, VA 22314

* Phone: 703-740-1100

Fax: 703-740-1101

Reply No Later Than:

Save Reset

Figure 8.2: View contents of a single DocPak

My DocPaks (Single DocPak) Page Bar

When viewing the contents of a single DocPak, the page bar gives you the option to add a Line Item to the DocPak, download or print the DocPak, and copy the DocPak, as well as activate or expire it as needed.

- *Print DocPak* – Displays printer options. You can send a DocPak directly to a printer; all associated documents are printed. For more information, see *Printer Options Page*.
- *Download DocPak* – Downloads the images of the document(s) within the DocPak to the client computer. All associated documents are downloaded. DocPaks are downloaded as a Zip file containing a directory structure identical to that displayed in the DocPaks page.
- *Download Index* – If the XE administrator has this feature enabled, you will see this link. A DocPak Index contains all documents from a DocPak and any of its Line Items in the form of a spreadsheet. The spreadsheet contains the list of the document's attributes including Revision and the original Filename with which the document was imported into the XE repository. For more information, see *Download a DocPak Index*.
- *Copy DocPak* – Copies the contents of the current DocPak displayed (including header attributes, line items, and documents) for the purposes of creating a new DocPak under a different name. Recipients are not copied. When this link is selected, the interfaces described in this section appear with the phrase "Copy of " prepended to the DocPak name. The new DocPak will have no references or links to the DocPak from which it was copied.
- *Activate DocPak* – Set a pending DocPak's start date (as displayed in the DocPak's header tab) to the current date, thus enabling all DocPak recipients to view its contents. Any pre-existing date entered within the DocPak header will automatically be overwritten and saved. If a previously published DocPak is reactivated, DocPak recipients are notified via e-mail.

Note

The *Activate DocPak* link only appears for DocPaks with a status of Pending.

- *Expire DocPak* – Set the date that a pending or active DocPak expires to the current date, thus immediately disabling the DocPak recipient’s ability to view its contents. If a previously published DocPak is expired, DocPak recipients are notified via e-mail.

Note

The *Expire DocPak* link only appears for DocPaks with a status of Active.

My DocPaks (Single DocPak) Content Area

The content area of this page consists of two panes. The left pane contains DocPak objects with links that you can click to navigate through the contents of the DocPak. Objects displayed in the left pane are highlighted upon selection. The right pane displays the contents of the object selected from the left pane. The following describe the contents of both panes.

My DocPak Name Page

The DocPak’s name is displayed as the first item in the left pane with the number of documents contained within the DocPak to the right of the name (this number does not include the number of documents stored within line items which are indicated separately). When selected, the following options are displayed in the right pane near the “Add documents to DocPak from:” header string:

- *Cabinet* – To add documents to a DocPak from a standard cabinet search, click the *Cabinet* link. This opens the document search page as described in *Search for Documents*. When documents are selected and *Add to DocPak* is clicked from the option bar of the Document Search Results page, you will be prompted to place the selected document(s) in the DocPak.



Figure 8.3: Click the *Cabinet* link to add documents to the DocPak

- *Cart* – To add documents to a DocPak from the Document Cart, click the *Cart* link. This opens the Add Document from Cart page as described in *Add documents to DocPak from the Document Cart*. When documents are selected and *Add to DocPak* is clicked from the option bar of the Document Cart page, you will be prompted to place the selected document(s) in the DocPak.



Figure 8.4: Click the *Cart* link to add documents to the DocPak

Note

DocPak recipients will be notified of the addition if the DocPak has already been published.

DocPak Header tab

The Header tab contains information that applies to the DocPak as a whole, not necessarily to its contents.

Figure 8.5: DocPak Header Tab

Each header contains the standard, required fields listed below. Additional fields may be present depending on the type of template used to create the DocPak.



- **Name** – Contains the name of the DocPak. The DocPak name must be unique within the repository. If you change the name of the header for a previously saved DocPak, a new DocPak will be created with the contents and structure of the pre-existing DocPak.
- **Description** – A text description of the DocPak.
- **Start Date** – The date that the contents of the DocPak can be viewed by DocPak recipients. Date can be entered manually in the text field or by clicking the calendar button  and selecting the desired month, year, and day.



Figure 8.6: Calendar

If a previously published and expired DocPak is reactivated, DocPak recipients are notified via e-mail.

- **Expiration Date** – Schedule the date that the DocPak expires. The date format is determined during Digital-Paper XE configuration. The date can be entered manually in the text field or by clicking the calendar button . If a previously published DocPak is expired, DocPak recipients are notified via e-mail.
- **Status** – Indicates whether or not a DocPak is:
 - **Pending** – The DocPak cannot be viewed by recipients because the start date has not been set or the start date occurs in the future.
 - **Active** – The DocPak's contents can be viewed by DocPak recipients.
 - **Expired** – The DocPak's expiration date has passed. The DocPak's contents can no longer be accessed by DocPak recipients.
- **Public** – Checkbox used to control whether or not the DocPak can be accessed by all Enterprise Users and Trading Partners via the Public DocPaks page as described in *Public DocPaks Pages*. Public DocPaks do not send creation or

change notifications as described below. If you wish to notify a selected group of users that a Public DocPak exists, you must add them to the list of recipients as described in *Recipients*.

- **Change Notification** – The change notification options are as follows:
 - *Approve changes before notifying participants* – Notifies the DocPak creator of new revisions that override existing documents within the DocPak via e-mail. The DocPak creator reviews and approves the changes made before notifying original DocPak recipients of the changes.
 - *Automatically notify recipients after a change has been made* – DocPak recipients will receive an e-mail notification of the document revisions on a scheduled basis.
- **Receive E-mail Notification for Publisher** – A marked checkbox will notify the DocPak creator of new revisions to documents. An unmarked checkbox will not notify the DocPak creator of any revision changes. In this case, the DocPak creator may still accept new revisions as described in *My DocPaks Updates Page*.
- **Suppress Email Notification for Recipients** – A marked checkbox will signal the DocPak to send no notifications to any of the recipients of the DocPak when an update occurs. This feature must be enabled by the XE administrator in order for this checkbox to be displayed.
- **Allow Recipients to Suppress Email Notification** – A marked checkbox will give the recipient permission to suppress email notifications for updates that may occur within the DocPak. This feature must be enabled by the XE administrator in order for this checkbox to be displayed.
- **Create DocPak Index** – If the XE administrator has this feature enabled, a marked checkbox will mark the DocPak to have its index created on a scheduled basis. The DocPak Index will be added to the DocPak as an attachment. For more information see *Download a DocPak Index*.

Click *Save* to preserve your entries or click *Reset* to clear the form.

Note
Clicking any other link without clicking the *Save* button will reset the form.

DocPak Documents tab

Clicking the *Documents* link in the right pane (or the number of documents in the left pane) displays all documents contained within the DocPak.



Figure 8.7: Documents tab

Documents tab option bar



The Documents tab option bar contains the following menu options:

- **Select All** – Clicking an empty *Select All* checkbox marks the checkboxes for all documents displayed. This feature is used to select all documents for the purpose of deletion, printing, or download. Clicking a marked *Select All* checkbox clears the checkboxes for all documents displayed.
- **Remove** – Deletes the selected document(s) from the DocPak. If the DocPak has already been published, DocPak recipients are notified via e-mail.

- *Print* – Displays printer options. You can send one or more selected documents directly to a printer. For more information, see *Printer Options Page*.
- *Download* – Downloads the image of the selected document(s) to the client computer. Multiple documents are compressed as a Zip file.

Documents tab content area

The Documents tab content area contains the following components:

- *Documents* – Lists each document within the DocPak, including its attributes. The number of documents that you have access to within the displayed list is indicated next to the "Documents" label. If the message indicates that you do not have access to one or more documents, the DigitalPaper XE Administrator may have revoked your rights to the cabinets in which the documents are stored.
- *Revision* – Displays the revision label of the document. Old revisions are marked with a red icon.
- *View* – Click the View icon  to open the document with DigitalPaper XE's Document Viewer. If the document is not in a format supported by the Viewer, clicking the View icon will start the process of downloading the document to your computer.
- *Properties* – Click the Properties icon  to display all attributes associated with a document, along with links that allow you to view, print, or download the document, as well as view its revision history and saved ViewMarks, if any. For more information, please see *Document Properties*.

My DocPaks Updates Page

Clicking the *Updates* link in the left pane of the DocPak displays the Updates page which maintains a list of documents stored within the DocPak that have been revised (and are pending approval), as well as a historical record of all updates applied to the DocPak.



Figure 8.8: DocPak Updates

Pending tab

Clicking the *Pending* link displays all documents within the DocPak that have a new revision (as long as the DocPak creator selected the "Approve changes before notifying participants" option during DocPak creation as described in *DocPak Header tab*. If so, each revised document is listed by its primary attributes, revision label, and the date the revision was made. In addition, the DocPak creator may view (or download) the document as well as display its properties. DocPak creators use this page to review each document and approve (or reject) the changes made before notifying DocPak recipients of the change.

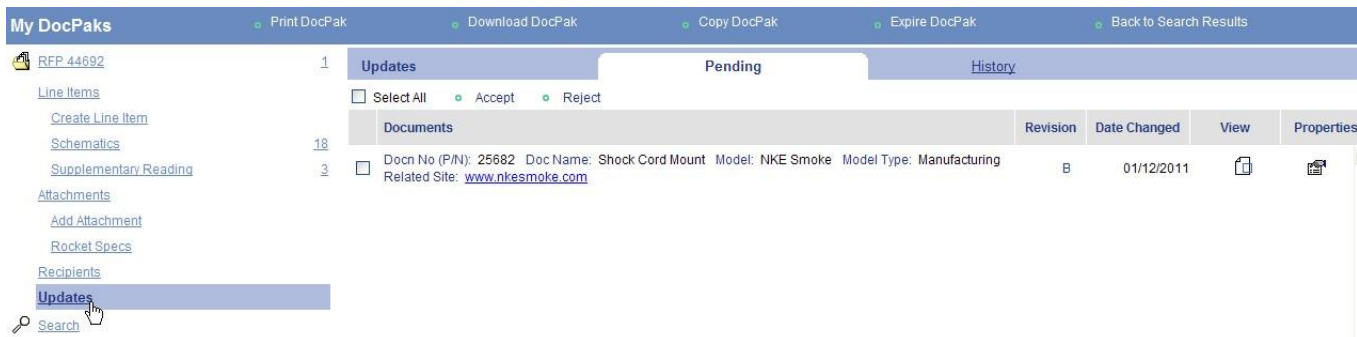

Figure 8.9: Updates page (Pending tab)

Note

If the DocPak creator did not select the "Approve changes before notifying participants" option during DocPak creation, the Pending tab will be blank.



Pending tab option bar

The Pending tab option bar contains the following menu options:

- *Select All* – Clicking an empty Select All checkbox marks the checkboxes for all documents displayed. This feature is used to select all documents for the purpose of printing, downloading or accepting all revisions displayed. Clicking a marked *Select All* checkbox clears the checkboxes for all documents displayed.
- *Accept* – Used by the DocPak creator to approve of the revisions made to the selected document(s) that were originally sent to DocPak recipients. If this option is selected, DocPak recipients are notified of the change via e-mail and may access the updated document from the DocPak listed in their Received DocPaks page. If this option is not selected, the original document shall remain intact in the recipient's DocPak. This option is not available if the DocPak creator did not specify the "Approve changes before notifying participants" option as described in *DocPak Header tab*.
- *Reject* – Used by the DocPak creator to reject revisions made to the selected document(s) that were originally sent to DocPak recipients. If this option is selected, the original document shall remain intact in the recipient's DocPak. Recipients are neither notified nor given access to new revisions. This option is not available if the DocPak creator did not specify the "Approve changes before notifying participants" option as described in *DocPak Header tab*.

Pending tab content area

The Pending tab content area contains the following components:

- **Documents** – Lists each document within the DocPak that is pending approval.
- **Revision** – Displays the revision label of the document.
- **Date Changed** – The month, day, and year that the last revision was made.
- **View** – Click the *View* icon  to open the document with DigitalPaper XE's Document Viewer. If the document is not in a format supported by the Viewer, clicking the *View* icon will start the process of downloading the document to your computer.
- **Properties** – Click the *Properties* icon  to display all attributes associated with a document. This also allows you to view, print, or download the document, as well as view its revision history and saved ViewMarks, if any. For more information, please see *Document Properties*.

History tab

Clicking the History link displays a historical record of all updates as they pertain to documents contained within DocPaks.

Documents	Revision	Date Changed	Location	Action	View
Docn No (P/N): 25679 Doc Name: Med Screw Eye Model Type: Manufacturing Related Site: www.nkesmoke.com	A	01/13/2011	Supplemental Reading	Added	
Docn No (P/N): 25681 Doc Name: Launch Lug Model Type: Manufacturing Related Site: www.nkesmoke.com	A	01/13/2011	Supplemental Reading	Added	
Doc No: 2009-11-30-1 Sheet: 1 Doc Name: Sentry Rocket Assy.	A	01/13/2011	Supplemental Reading	Deleted	
Doc No: 2009-11-25-1 Sheet: 1 Doc Name: Nike Smoke Assy.	C	01/13/2011	Supplemental Reading	Deleted	
Doc No: RFQ 90-A13 Sheet: 1 Doc Name: RFQ Draft	A	01/12/2011	RFQ 90-A13 DRAFT	Removed via Update	
Doc No: RFQ 90-A13 Sheet: 1 Doc Name: RFQ Draft	B	01/12/2011	RFQ 90-A13 DRAFT	Added via Update	

Figure 8.10: Updates page (History tab)

History tab content area

The History tab content area contains the following components:

- Documents – Lists each document within the DocPak with its primary attributes.
- Revision – Displays the revision label of the document. Old revisions are marked with a red icon.
- Date Changed – The month, day, and year that the last revision was made.
- Location – The name of the DocPak or Line Item where the document is referenced.
- Action – The type of update that was implemented for each document. These updates may be one of the following:
 - Removed via Update – A new revision of the document was released to the repository by the Indexing Specialist thus removing this document from the DocPak.
 - Added via Update – A new revision of a document present in the DocPak was released to the repository by the Indexing Specialist thus adding this document to the DocPak.
 - Added – The document listed was added to the DocPak.
 - Deleted – The document listed was removed from the DocPak by the DocPak creator, or removed from the system by the Indexing Specialist.
- View – Click the *View* icon to open the document with DigitalPaper XE's Document Viewer. If the document is not in a format supported by the Viewer, clicking the *View* icon will start the process of downloading the document to your computer.

Search DocPak Updates

If the XE administrator has enabled "Search for DocPak Updates", the creator of a DocPak may search all updates for the DocPak based on a date range that may be entered.

Click the *Search DocPak Updates* link from the left pane of the DocPak page.

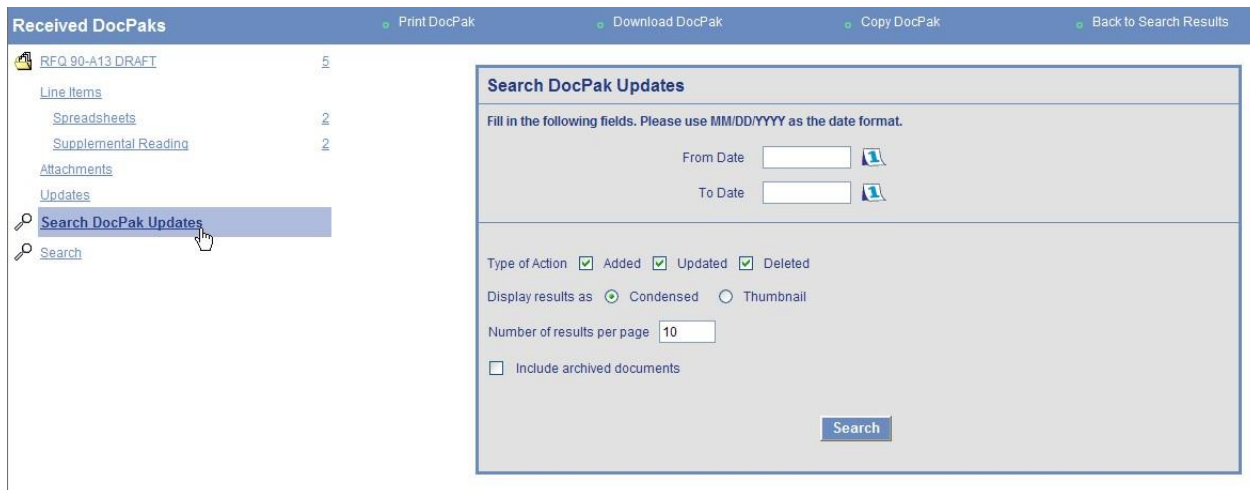

Figure 8.11: Search DocPak Updates

Search DocPak Updates Criteria Page

The following search criteria may be entered on the page:

- *From Date* - Text field that accepts a valid date that will be used as the start of the date range for which to search for DocPak Updates.
- *To Date* - Text field that accepts a valid date that will be used as the end of the date range for which to search for DocPak Updates.
- *Type of Action* - Checkbox field that will allow a user to search on a specific type of update that was implemented for each document. Types of Action include Added, Updated (includes Added via Update and Removed via Update) and Deleted.
- *Display Results as* - Radio buttons that determine how the search results will be displayed. Possible selections are condensed and thumbnail.
- *Number of results per page* - Text field that determines the number of results per page that will be displayed once the search completes.

Search for Documents Within a DocPak

The creator of a DocPak may search for documents within the DocPak.

Click the *Search* link in the left pane of the main page of an individual DocPak.

My DocPaks Print DocPak Download DocPak Copy DocPak Expire DocPak Back to Search Results

RFQ 90-A13 DRAFT 5

Line Items

Create Line Item

Spreadsheets 2

Supplemental Reading 2

Attachments

Add Attachment

Recipients

Updates

Search

Search For Documents Within DocPak

Fill in one or more of the following fields. Hint: 123* finds all documents starting with 123

Document Number

Document Revision

Type of search Match Any Field Match All Fields

Display results as Condensed Thumbnail Sorted

Number of results per page

Include archived documents

Include Line Items in Search

Automatically view if only one result is found

Search

Figure 8.12: DocPak Document Search

Fill in the search criteria and search for documents as described in *Search for Documents*. In addition to the standard search criteria, the checkbox *Include Line Items in Search* will also appear. If this box is checked, the search will be performed on documents in the top level DocPak along with all documents located in the line items. If the checkbox is not marked, the search will be performed on documents in the top level DocPak only.

Search for Documents within a Specific Line Item

If the XE administrator has enabled specific Line Item searches, the user will see a drop down list containing all the Line Items in the DocPak.

My DocPaks Print DocPak Download DocPak Copy DocPak Expire DocPak Back to Search Results

RFQ 90-A13 DRAFT 5

Line Items

Create Line Item

Spreadsheets 2

Supplemental Reading 2

Attachments

Add Attachment

Recipients

Updates

Search

Search For Documents Within DocPak Select Line Item:

Fill in one or more of the following fields. Hint: 123* finds all documents starting with 123

Document Number

Document Revision

Type of search Match Any Field Match All Fields

Display results as Condensed Thumbnail Sorted

Number of results per page

Include archived documents

Include Line Items in Search

Automatically view if only one result is found

Search

Figure 8.13: Specific Line Item Search

By selecting a specific Line Item from the drop down menu, the search will be performed on the selected Line Item and return documents matching the search criteria entered. The top level DocPak and all other Line Items will not be searched.

If *All* is selected then the search will be performed on all Line Items in the DocPak. The top level DocPak will not be searched for documents matching the search criteria.

If nothing is selected from the drop down menu, then the search will be performed on the top level DocPak. All Line Items will also be searched if the *Include Line Items in Search* checkbox is checked.

Recipients

Click the *Recipients* link in the left pane to view all users and groups who have received or will receive the DocPak. From this link you may also add new recipients.

The screenshot shows the 'Recipients' page for a DocPak. The top navigation bar includes 'My DocPaks', 'Print DocPak', 'Download DocPak', 'Copy DocPak', 'Expire DocPak', and 'Back to Search Results'. The left pane shows a list of options: 'RFQ 90-A13 DRAFT', 'Line Items', 'Create Line Item', 'Spreadsheets', 'Supplemental Reading', 'Attachments', 'Add Attachment', 'Recipients' (highlighted), 'Updates', 'Search DocPak Updates', and 'Search'. The main content area has a sub-header 'Add to Recipients from:' with 'Users' and 'Groups' tabs. Below this is a table of recipients:

Recipients	Description
<input type="checkbox"/> Engineering	Engineering and technician group
<input type="checkbox"/> Manufacturing	
<input type="checkbox"/> eu	Enterprise User
<input type="checkbox"/> jharbaugh	John Harbaugh
<input type="checkbox"/> jjones	Jim Jones
<input type="checkbox"/> mmccarthy	Mike McCarthy
<input type="checkbox"/> msmith	Mike Smith

Figure 8.14: Recipients page

Recipients pane option bar

The Recipients option bar contains the following menu options:

- *Users* – Click *Users* to add individual users to the recipients list. See *Add Recipients from: Users* for more information.
- *Groups* – Click *Groups* to add all users in a group to the recipients list. See *Add to Recipients from: Groups* for more information.
- *Select All* – Clicking an empty *Select All* checkbox marks the checkboxes for all users and groups displayed. This feature is used to select all users and groups for the purpose of deleting them as DocPak recipients. Clicking a marked *Select All* checkbox clears the checkboxes for all users and groups displayed.
- *Remove* – Removes the selected users and groups as recipients of the DocPak.

Recipients pane content area

The Recipients content area contains the following components:

- *Recipients* – The names of users and/or groups who have received or will receive the DocPak.
- *Description* – The first and last name of the user and/or the group description as optionally entered by the Application Configuration Specialist.

Add Recipients from: Users

Click the *Users* link to display a pre-defined list of users that may be added as DocPak recipients.

User Name	Name	Company Name
<input type="checkbox"/> ablack	Alex Black	ePlus
<input type="checkbox"/> administrator		
<input type="checkbox"/> bbelichick	Bill Belichick	Patriot Way Corp.
<input type="checkbox"/> bbernardino	Bernie Bernardino	ePlus
<input type="checkbox"/> eu	Enterprise User	ePlus
<input type="checkbox"/> indexer		
<input type="checkbox"/> jharbaugh	John Harbaugh	Raven Defensive Systems, Inc.
<input type="checkbox"/> jjones	Jim Jones	ePlus
<input type="checkbox"/> lsmith	Lovie Smith	Bear Media
<input type="checkbox"/> mmccarthy	Mike McCarthy	Green Bay Packing Co.
<input type="checkbox"/> msmith	Mike Smith	Falcon Engineering LLC
<input type="checkbox"/> mtomlin	Mike Tomlin	Pittsburg Steel Corp.
<input type="checkbox"/> pcarroll	Paul Carroll	ePlus
<input type="checkbox"/> pecarroll	Pete Carroll	Seahawk Systems LLC

Figure 8.15: Add recipients from Users list

Users tab option bar

The Users option bar contains the following menu options:

- *Select All* – Clicking an empty *Select All* checkbox marks the checkboxes for all users displayed. This feature is used to select all users for the purpose of adding them as DocPak recipients. Clicking a marked *Select All* checkbox clears the checkboxes for all users displayed.
- *Add to Recipients* – Click this link to add the selected user(s) to the main Recipients page. Users that have been added are removed as options from the Users tab to prevent sending the same user multiple e-mails when the DocPak becomes active.
- *Search Users* – Click this link to search for a user in the Search Users page. You may perform the search based on one or more of the following characteristics: username, first name, last name, company name, or e-mail address.

Figure 8.16: Search Users page

Click *Search* to search all users defined in the system and display the results in the Users tab. Click *Reset* to clear the form, or *Cancel* to return to the Recipients page.

Users tab content area

The Users content area contains the following components:

- User Name – Name used by the recipient to log into the system in order to view the DocPak contents. Clicking the *e-mail* icon  next to a user's name launches the e-mail application installed on your computer, and opens a message window with the "To:" field pre-filled with the user's e-mail address.
- Name – A more descriptive name for each username.
- Company Name – Name of the company that employs the user. This field is optionally completed by the Administrator.

Add to Recipients from: Groups

Click the Groups link to view and select all users within a pre-defined group.



The screenshot shows the 'Add to Recipients from: Groups' interface. At the top, there are navigation links: 'Print DocPak', 'Download DocPak', 'Copy DocPak', 'Expire DocPak', and 'Back to Search Results'. Below these, there are tabs for 'Users' and 'Groups', with 'Groups' being the active tab. A 'Back to Recipients' link is also present. The main content area is a table with columns for 'Group' and 'Description'. Each row has a checkbox in the 'Group' column. The groups listed are: Administrators, ConfigurationSpecialists, Customers (description: Our primary customers), DocPakAdministrators, EnterpriseUsers, Field Service (description: Third party field service providers), IndexingSpecialists, PM (description: Product management and marketing), Publishers, Quality Control (description: QA/QC Department), Suppliers (description: Global suppliers), and TradingPartners.

Figure 8.17: Add recipients from Groups

Groups tab option bar

The Groups option bar contains the following menu options:

- *Select All* – Clicking an empty *Select All* checkbox marks the checkboxes for all groups displayed. This feature is used to select all groups for the purpose of adding them as DocPak recipients. Clicking a marked *Select All* checkbox clears the checkboxes for all groups displayed.
- *Add to Recipients* – Click this link to add the selected group(s) to the main Recipients page. Groups that have been added are removed as options from the Group tab to prevent sending the same group multiple e-mails when the DocPak becomes active.

Groups tab content area

The Groups content area contains the following components:

- Group – Name of group.
- Description – Text description of group.

Back to Recipients

Click *Back to Recipients* to return to the main Recipients page.

Line Items Main Page

If Line Items exist within the DocPak, they are listed beneath the "Line Item" heading in the left pane with the number of documents contained within the Line Item.

Click the Line Items title in the left pane to display a summary list of all Line Items in the DocPak.

Name	Description	Document Count
<input type="checkbox"/> Agenda	Focus group agenda	1
<input type="checkbox"/> List of Questions	The list of questions posed to the focus group participants	1
<input type="checkbox"/> Slides	The slides used to facilitate the presentation	2
<input type="checkbox"/> Subjective Results	Contains the written and oral responses of the focus group participants	2

Figure 8.18: Line Item Summary

The columns within the content area are as follows:

- Name – Contains the name of each Line Item. Click a name link to display the contents of the Line Item as described in *Line Items Page (Single Line Item)*.
- Description – A text description of the Line Item.
- Document Count – The number of documents associated with the Line Item.

Line Items Page (Single Line Item)

Click any Line Item title to add documents to the Line Item or display the Line Item's summary information as well as view the documents within the Line Item.

My DocPaks

Focus Group Results 3

Line Items

Create Line Item

Agenda 1

List of Questions 1

Slides 2

Subjective Results 2

Attachments

Add Attachment

Recipients

Updates

Search DocPak Updates

Search

Add documents to Line Item from: Cabinet Cart

Header Documents

* Name List of Questions

Description The list of questions posed to the focus group participants

Save Reset

Figure 8.19: Line Item Header tab

Add documents to Line Item from *Cabinet*

Click the *Cabinet* link to display the Documents Search page (as described in *Search for Documents*) in the right pane. Once a search has been conducted, the search results screen displays and you can choose the documents you wish to add using the *Add to Line Item* link in the Document Search Results option bar.

Note

If adding a document to a Line Item within a DocPak that is already active, the DocPak recipients will be notified of the addition via e-mail.

Add documents to Line Item from the Document Cart

Click the *Cart* link to display the Documents Cart page (as described in *Document Cart*) in the right pane. Once the cart has been displayed, you can choose the documents you wish to add using the *Add to Line Item* link in the Document Cart option bar.

Note

If adding a document to a Line Item within a DocPak that is already active, the DocPak recipients will be notified of the addition via e-mail.

Line Item Header tab

The header tab contains the standard, required Line Item fields listed below. Additional fields may be present depending on the type of template used to create the Line Item.

The screenshot shows the 'Line Item Header' tab interface. On the left, a navigation pane lists various items: 'Focus Group Results' (3), 'Agenda' (1), 'List of Questions' (1), 'Slides' (2), and 'Subjective Results' (2). The 'Subjective Results' item is selected. The main content area shows a form with the following fields:

- Name:** Subjective Results
- Description:** Contains the written and oral responses of the focus group participants

At the bottom of the form are 'Save' and 'Reset' buttons. The top navigation bar includes 'My DocPaks', 'Print DocPak', 'Download DocPak', 'Copy DocPak', 'Expire DocPak', and 'Back to Search Results'.

Figure 8.20: Line Item Header tab

- Name – Contains the name of the Line Item as it appears in the left pane.
- Description – A text description of the Line Item.

Click the *Save* button to save changes to the Line Item or *Reset* to clear the form.

Line Item Documents tab

The Documents tab displays all documents contained within the Line Item using the same interface described earlier for DocPaks.

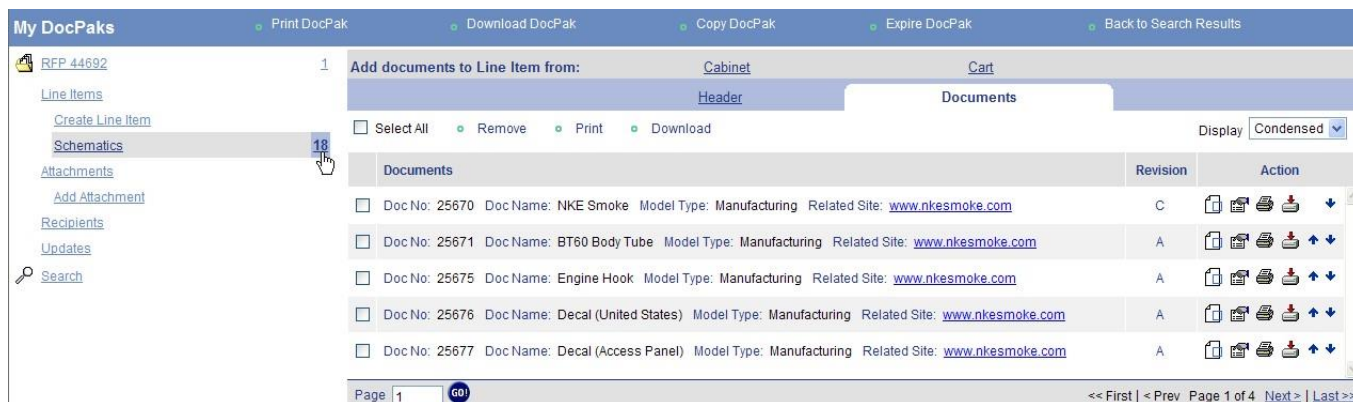

Figure 8.21: Line Item Documents tab



Lien Item Documents tab option bar

The Line Item Documents tab option bar contains the following menu options:

- *Select All* – Clicking an empty *Select All* checkbox marks the checkboxes for all documents displayed. This feature is used to select all documents for the purpose of deletion, printing, or downloading. Clicking a marked *Select All* checkbox clears the checkboxes for all documents displayed.
- *Remove* – Deletes the selected document(s) from the Line Item. DocPak recipients are notified via e-mail of the change.
- *Print* – Displays printer options. You can send one or more selected documents directly to a printer. For more information, see *Printer Options Page*.
- *Download* – Downloads the image of the selected document(s) to the client computer. Multiple documents are compressed as a Zip file.

Line Item Documents tab content area

The Line Item Documents content area contains the following components:

- **Documents** – Lists each document within the Line Item, including its attributes. The number of documents you have access to within the displayed list is indicated next to the "Documents" label. If the message indicates you do not have access to one or more documents, the DigitalPaper XE Administrator may have revoked your rights to the cabinets in which the documents are stored.
- **Revision** – Displays the document's revision label. Old revisions are marked with a red icon.
- **View** – Click the *View* icon  to open the document with DigitalPaper XE's Document Viewer. If the document is not in a format supported by the Viewer, clicking the View icon will start the process of downloading the document to your computer.
- **Properties** – Click the *Properties* icon  Displays all attributes associated with a document, and allows you to view, print, or download the document, as well as view its revision history and saved ViewMarks, if any. For more information, please see *Document Properties*.

Attachments Main Page

If Attachments are present within the DocPak, the attachments will be listed under the *Attachments* heading in the left pane.

Click the *Attachments* heading in the left pane to display a summary list of all Attachments in the DocPak.

The screenshot shows the 'My DocPaks' interface. The left sidebar has 'Attachments' selected. The main content area shows a table with the following data:

Name	Description
<input type="checkbox"/> Rocket Specs	This attachment is a spreadsheet containing the specs for the rocky assembly.
<input type="checkbox"/> Updated Schematics	The attached spreadsheet contains updated schematics on some parts.

At the top of the main area, there is an option bar with 'Select All', 'Download', and 'Delete' buttons. The left sidebar also includes links for 'Line Items', 'Schematics', 'Supplementary Reading', 'Add Attachment', 'Rocket Specs', 'Updated Schematics', 'Recipients', 'Updates', 'Search DocPak Updates', and 'Search'.

Figure 8.22: DocPak Attachments List

Attachments Option Bar

The Attachments option bar allows for selection of all listed Attachments, as well as downloading selected Attachments.

- *Select All* – Clicking an empty *Select All* checkbox marks the checkboxes for all Attachments displayed. This feature is used to select all Attachments for the purpose of downloading or deletion. Clicking a marked *Select All* checkbox clears the checkboxes for all Attachments displayed.
- *Download* – Downloads the selected Attachments to the client computer. If more than one Attachment is selected then the attachments are downloaded as a zip file. If one attachment is selected to be downloaded, then the attachment's original filename will be used.
- *Delete* – Permanently removes the selected Attachments(s) from the Attachments page. Recipients of the DocPak will be notified via e-mail of the deletion of the attachment.

Attachments content area

The columns within the content area are as follows:

- *Name* – Contains the name of each Attachment. Click a name link to display the Attachment's summary information as described in *Attachments Page (Single Attachment)*.
- *Description* – A text description of the Attachment.

Attachments Page (Single Attachment)

Click any Attachment to display the Attachment's summary information. The name and description of the attachment may be modified here.



Figure 8.23: Attachment Header Page

Copy DocPak URL to Clipboard

If the XE administrator has enabled the “Copy to Clipboard” functionality, the user may copy the DocPak URL to the clipboard on his or her computer.

Click the *Copy DocPak URL to Clipboard* link in the left pane of the main DocPak page.

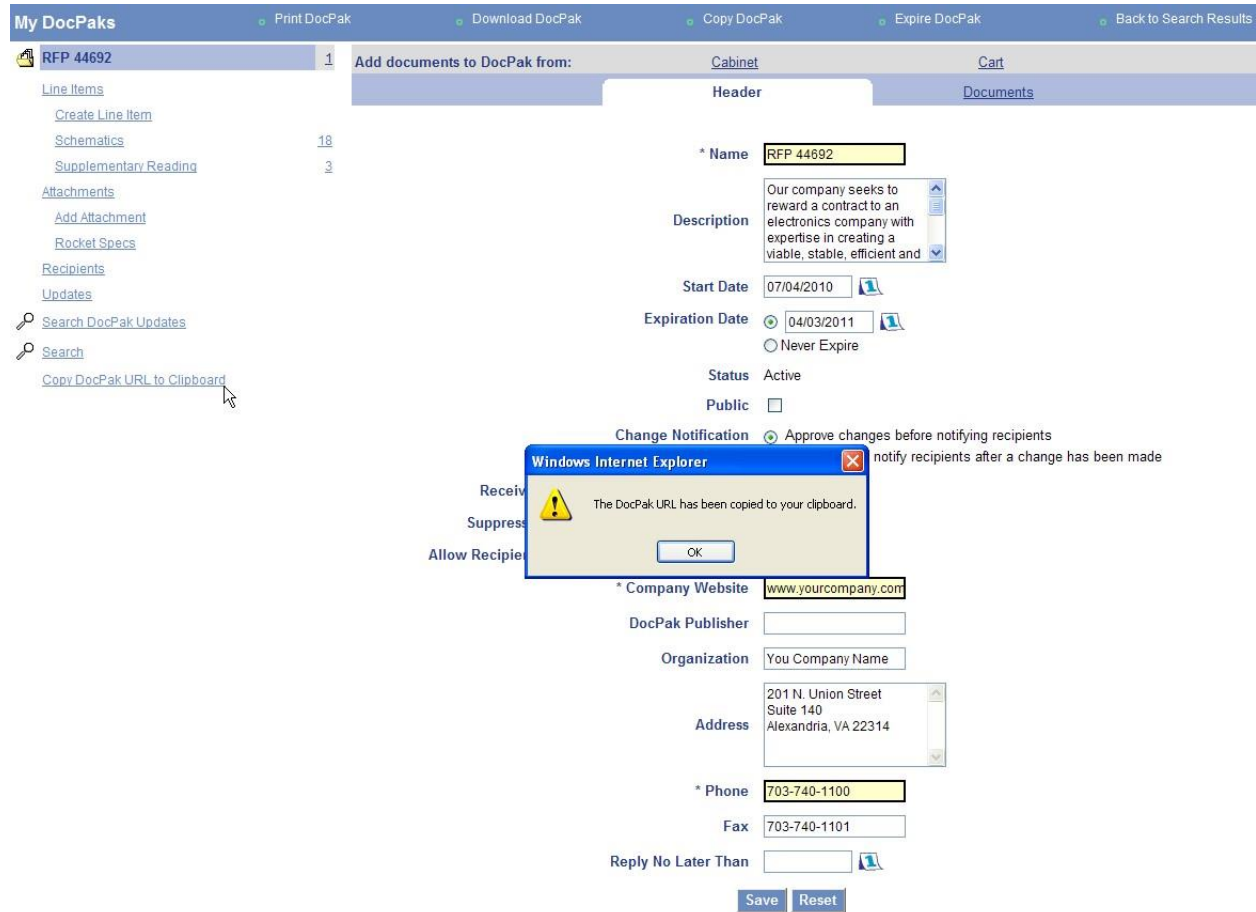

Figure 8.24: Copy DocPak URL to Clipboard

When the URL has been copied a confirmation message will be displayed. Click *OK* to clear the message.

The DocPak URL is now located in the user's clipboard. The user may find this useful to paste the URL into an email.

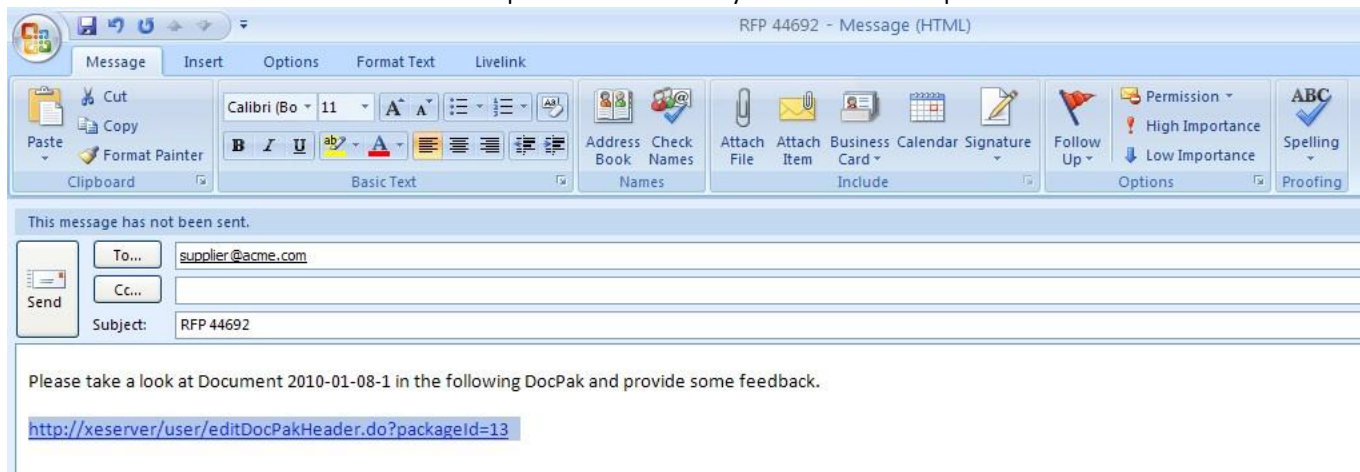

Figure 8.25: DocPak URL Copied into Email

Note

The Copy DocPak URL to Clipboard functionality will only work with an Internet Explorer web browser.

Received DocPaks Pages

Received DocPaks are those DocPaks you have received from other Enterprise Users. This interface behaves similarly to the My DocPaks pages, with the following exceptions:

- The Received DocPaks option bar contains a *Show My DocPaks* link that returns you to the My DocPaks page described in *My DocPaks Main Page*.
- DocPaks in the pending or expired state are not displayed in the main Received DocPaks page.
- You cannot modify any of the contents of a received DocPak nor delete it. You can only view, print, download or copy a received DocPak.
- The Updates page for received DocPaks will not provide you with the option to view document revisions for the purpose of accepting changes.

Public DocPaks Pages

Public DocPaks are those DocPaks that have been made available to all Enterprise Users and Trading Partners (if applicable). This interface behaves similarly to the Received DocPaks pages, except a Public DocPak does not require recipients to be assigned to it when published; assignment of recipients to Public DocPaks is optional.

Create DocPak and Line Items Tools

Create DocPak Page

To create a DocPak, click the *Create DocPak* link from the option bar located on either the My DocPaks, Received DocPaks, or Public DocPaks page to open the Create DocPak form.

Figure 8.26: Create DocPak

The fields in the form are:

- Name – Text field used to enter the name of the DocPak as it appears in all DocPaks pages upon publication. This field is required.
- Template – An optional selection, the template controls the header attribute information displayed to both Enterprise Users and Trading Partners when viewing the contents of a DocPak. Templates contain fixed, required fields as well as custom fields defined by the Application Configuration Specialist. For more information on header attributes, see *DocPak Header tab*.
- Description – An optional text field used to enter a description of the DocPak. This information is displayed to both Enterprise Users and Trading Partners when viewing the contents of a DocPak.

Click *Save* to create the DocPak and automatically display the new DocPak in its own page as described in *My DocPaks (Single DocPak)*. Click *Cancel* to abandon DocPak creation and return to the main DocPaks page you were on when you clicked the *Create DocPak* link.

Create Line Items

A Line Item is part of a hierarchical structure within a DocPak used to group a collection of documents. Line Items are one level deep (i.e., a Line Item cannot contain another line item). Line Items can only be created from the My DocPaks page that displays a single DocPak. Click the *Create Line Item* link from the My DocPaks page's left pane to create a Line Item using the interface shown below.

Figure 8.27: Create Line Item

The fields in the form are:

- Name – Text field used to enter the name of the Line Item as it appears in all DocPaks pages upon publication. This field is required.

- **Template** – An optional selection, the template controls the Line Item’s header attribute information displayed to both Enterprise Users and Trading Partners when viewing the Line Item contents contained within a DocPak. Templates contain fixed, required fields as well as custom fields defined by the Application Configuration Specialist. For more information on Line Item header attributes, see *Line Item Header tab*.
- **Description** – An optional text field used to enter a description of the Line Item. This information is displayed to both Enterprise Users and Trading Partners when viewing the contents of a Line Item.

Click *Save* to create the Line Item and automatically display the new Line Item in its own page as described in *Line Item Header tab*. Click *Cancel* to abandon Line Item creation and return to the page you were on when you clicked the *Create Line Item* link.

Create Attachments

An Attachment is part of a hierarchical structure within a DocPak that is used to add documents, external to the XE repository, to the DocPak. Attachments can only be created from the My DocPaks page that displays a single DocPak. Click the *Add Attachments* link from the My DocPaks page’s left pane to create an Attachment using the interface shown below.

Figure 8.28: Create Attachment

The fields in the form are:

- **File** – Text field used to specify a file located on the client computer that will be uploaded to the XE server as the attachment. (Click *Browse* to specify the file by viewing the directories on the client.) This field is required.
- **Name** – Text field used to enter the name of the Attachment as it appears in all DocPaks pages and to DocPak recipients upon publication. This field is required.
- **Description** – Text area that is used to give a brief description of the purpose of the attachment. This field is optional.

Click *Save* to create the Attachment. Click *Cancel* to abandon Attachment creation and return to the page you were on when you clicked the *Add Attachment* link.

Import DocPak Pages

This section describes the DigitalPaper XE pages and file formats used to import a DocPak.

DocPak Import File Formats

DocPaks to be imported are defined within text files. The text files contain the information required to construct the DocPak.

Two different text file formats are supported - XML and CSV. In the discussions that follow the use of both file formats will be described.

Import DocPak Page 1

To import a DocPak of either format, click the *Import DocPak* link from the option bar located on either the My DocPaks, Public DocPaks or Received DocPaks page to open the Import DocPak screen.

The screenshot shows the 'Import DocPak' dialog box. The title bar reads 'Import DocPak'. In the top right corner, there is a dropdown menu labeled 'Type of Import' with 'XML' selected. Below this, there is a field labeled '* Import File' which is currently empty, followed by a 'Browse...' button. At the bottom of the dialog, there are two buttons: 'Next' and 'Cancel'.

Figure 8.29: Import DocPak via XML File page 1

Note

In this example, *XML* has been selected from the “Type of Import” drop-down listbox. A CSV example is provided below.

Enter the location and name of the XML file that contains the DocPak definition records as the Import File. Click *Browse* to navigate through local storage and select the file.

CSV may also be selected from the “Type of Import” drop down box on the Import DocPak page.

The screenshot shows the 'Import DocPak' dialog box with 'Type of Import' set to 'CSV'. The fields are as follows: '* Search Attributes' is 'DOCNO' with an 'Attribute List' link; '* Search Attribute Types' is 'TEXT'; 'Data Delimiter' is 'Comma [,]' with a dropdown arrow; 'Import File' is 'C:\Development\Import\DocPak\...' with a 'Browse...' button; and 'Additional Data' is a text area containing '256*' and '2010*'. At the bottom, there are 'Next' and 'Cancel' buttons.

Figure 8.30: Import DocPak via CSV File page 1

For CSV imports, the following attributes must be specified:

- Search Attributes - Text field used to enter a pipe delimited list of attribute names that will be used to search for documents for the DocPak. This is a required field.
- Search Attribute Types - Text field used to enter a pipe delimited list of attribute types of the attribute names entered in the Search Attributes text field. Possible values are TEXT, NUMBER and DATE. This is a required field.
- Data Delimiter - Drop down field used to configure the delimiter used to separate attribute values in the CSV. Possible selections are *Comma[,]*, *Pipe[|]*, and *Tab[]*.
- Import File - Text field used to enter the location of the CSV file that contains the attribute values that will be used as search criteria to find documents to be included in the DocPak. Click *Browse* to navigate through local storage and select the file.
- Additional Data - Text area used to manually enter search criteria. The attribute values must match the number of attribute names entered in the Search Attributes text field and separated by the delimiter specified in the Data Delimiter drop down field. Each set of search criteria must be placed on a separate line in the text area.

Click *Parse* to import the DocPak. Click *Cancel* to return to the DocPaks page you were on when you clicked the *Import DocPak* link.

Import DocPak Page 2

The second Import DocPak screen (shown below) displays the DocPak's header information as defined by the XML file.

Note

For CSV imports, all header information must be entered manually.

Import DocPak

* Name

Template

Description

Start Date

Expiration Date 07/28/2011 Never Expire

Public

Change Notification Approve changes before notifying recipients
 Automatically notify recipients after a change has been made

Receive Email Notification for Publisher

Figure 8.31: Import DocPak page 2

Note

The fields on this page are described in detail in *DocPak Header tab*.

Click *Import* to create the DocPak according to the date entered in the page above as well as the data defined in the import file. If the DocPak was successfully created, you will be taken to the My DocPaks page described in *My DocPaks (Single DocPak)*. If unsuccessful, a detailed error message appears. Click *Cancel* to return to the DocPak page you were on when you clicked the *Import DocPak* link.

Note

Detailed information about DocPak import file formats can be found in the *Administration and Application Configuration Guide*.

Search DocPaks Page

To search for a specific DocPak, click the *Search DocPaks* link that appears on each main page for My DocPaks, Received DocPaks, and Public DocPaks.

Figure 8.32: Search DocPaks

You can use the Search DocPaks page to perform a search based on a DocPak's required attributes.

Note
Searches are not case-sensitive.

Optional search attributes include:

- DocPak pull-down menu – Select the type of DocPak you are searching for from the pull-down menu: *Received DocPaks* will be the only option for Trading Partners.
- *Name* – Search for one or more DocPaks by name as assigned by the DocPak creator. You may use asterisks (*) to perform a wildcard search. For example, to search for both *Project Horizon A* and *Product Horizon B* you would enter **Horizon**.
- *Description* – Search by DocPak description. As with name searches, use one or more asterisks to perform a wildcard search.
- *Expires Between* – Search for DocPaks that expire within this date range.
- *Starts Between* – Search for DocPaks that start within this date range.
- *Updated Between* – Search for DocPaks that have been updated within this date range.
- *Status* – The DocPak's current status:
 - *All* – Search on any of the statuses listed below.

- *Pending* – The DocPak cannot be viewed by recipients because the start date has not been set or the start date occurs in the future.
- *Active* – The DocPak’s contents can be viewed by DocPak recipients.
- *Expired* – The DocPak’s expiration date has passed. The DocPak’s contents can no longer be accessed by DocPak recipients.
- *Type* – The template (e.g., General, RFP, RFQ, Work Order) that may have been used to create the DocPak.
- *Sort* – Specify the order in which the results should be sorted. Specify *Ascending* or *Descending* to specify the alphabetic sort order; specify the sort criteria (e.g. *Name*) on which to sort.
- *Automatically view if only one result is found* – Check this box if you would like to display the DocPak contents directly (without listing the DocPak in a search results page) if a single DocPak matches the search criteria.
- *Include Archived DocPaks* – Check this box if you would like to search all DocPaks, including those that have been archived because they have been automatically archived by DigitalPaper XE.

Click *Search* to search all received DocPaks and display the results in the DocPak Search results page as shown below. Click *Reset* to clear the form, or *Cancel* to return to the DocPak page you were on when you clicked *Search DocPaks*.

DocPak Search Results Page

Search results are displayed in the appropriate DocPak Main Page but lists only the DocPaks that matched your search criteria.

Received DocPak Search Results [1 found]							Show My DocPaks	Show Public DocPaks	Create DocPak	Import DocPak	Search DocPaks
<input type="checkbox"/> Select All <input type="checkbox"/> Print <input type="checkbox"/> Download											
Name ^	Description	Updated	Starts	Expires	Type	Status					
<input type="checkbox"/> Ensuring Quality	QA/QC programs for project Horizon	01/11/2011	05/12/2010	05/11/2011		Active					

Figure 8.33: DocPak search results

Download a DocPak Index

Note

The XE administrator must enable and configure this functionality so that a recipient of a DocPak may use this feature.

A DocPak Index contains all documents from a DocPak and any of its Line Items in the form of a spreadsheet. The spreadsheet contains the list of the document’s attributes including its revision and the original filename with which the document was imported into the XE repository.

You have two options to download the DocPak index:

1. From the Received DocPaks page, mark the checkbox next to each DocPak you wish to download an index for. If you wish to download the index of all DocPaks displayed, click *Select All*.
2. Click the *Download Index* link. A file download dialog appears. Follow the steps listed in *Download a Document*.

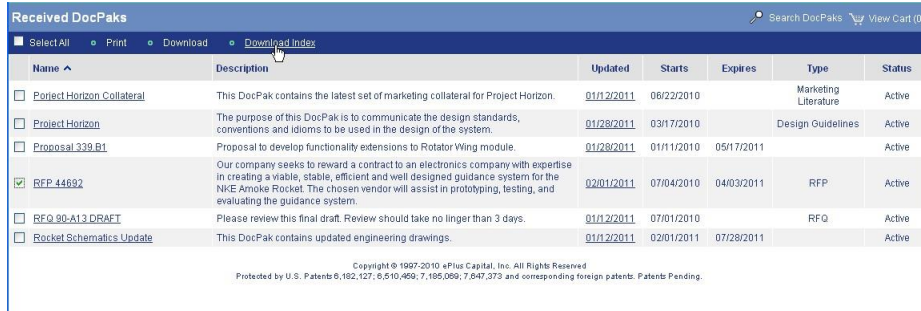

Figure 8.34: Download one or more DocPak Indexes from the main DocPaks page

- Click the name of a DocPak on the main Received DocPaks page to display the contents of that DocPak, then click *Download Index* from the page bar. A file download dialog appears. Follow the steps listed in *Download a Document*.

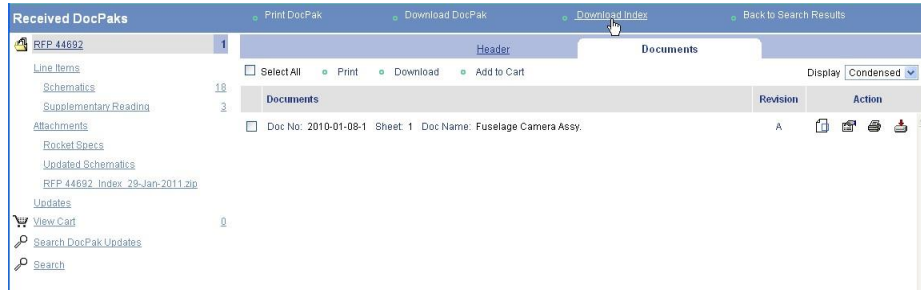

Figure 8.35: Download an individual DocPak Index

The DocPak is downloaded as a spreadsheet file containing a sheet structure where the main DocPak's contents are listed in a sheet. Each Line Item's content is listed in a separate sheet. The image below represents the DocPak Index for a DocPak with two line items.

Doc No	Doc Name	Revision	FileName
2	RFQ 90-A13	1 B	25800B.tif
3	2009-11-25-1	1 C	25670C.tif
4	2009-11-30-1	1 A	25800B.tif
5	2009-12-21-1	1 A	25800B.tif
6	2010-01-08-1	1 A	318661.tif

Figure 8.36: DocPak Index Spreadsheet

Chapter 9

Document Cart

This chapter describes the use of the DigitalPaper XE Document Cart:

- *Document Cart Overview.*
- *Document Cart Functions.*

Document Cart Overview

The Document Cart allows an Enterprise User to group documents into a common area. The documents may be from more than one cabinet depending on the user's access permissions. The cart is useful to group documents that a user frequently needs. These documents may be viewed, printed and downloaded.

To add documents to the cart, a document search must be performed. (For more information, see *Working with Documents.*) The user may then select the documents to add to the cart. Once the documents are selected, click on the *Add to Cart* link. The documents are then added to the cart. The number of documents in the cart is indicated next to the *View Cart* link in the Document Search Results Page Bar.

To view your cart, click on the *View Cart* link in the Document Search Results Page Bar or the user's home page.

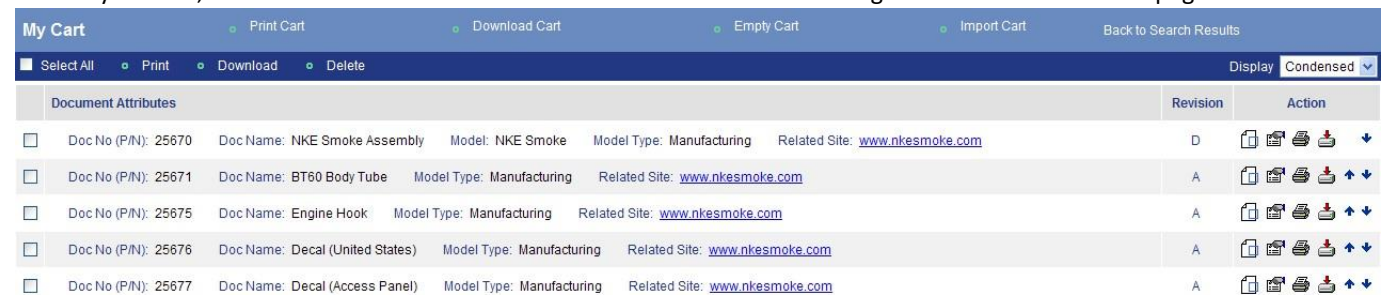

My Cart						Print Cart	Download Cart	Empty Cart	Import Cart	Back to Search Results	
<input type="checkbox"/> Select All <input type="checkbox"/> Print <input type="checkbox"/> Download <input type="checkbox"/> Delete						Display Condensed					
Document Attributes						Revision	Action				
<input type="checkbox"/> Doc No (P/N): 25670	Doc Name: NKE Smoke Assembly	Model: NKE Smoke	Model Type: Manufacturing	Related Site: www.nkesmoke.com		D					
<input type="checkbox"/> Doc No (P/N): 25671	Doc Name: BT60 Body Tube	Model Type: Manufacturing	Related Site: www.nkesmoke.com			A					
<input type="checkbox"/> Doc No (P/N): 25675	Doc Name: Engine Hook	Model Type: Manufacturing	Related Site: www.nkesmoke.com			A					
<input type="checkbox"/> Doc No (P/N): 25676	Doc Name: Decal (United States)	Model Type: Manufacturing	Related Site: www.nkesmoke.com			A					
<input type="checkbox"/> Doc No (P/N): 25677	Doc Name: Decal (Access Panel)	Model Type: Manufacturing	Related Site: www.nkesmoke.com			A					

Figure 9.1: Document Cart

Document Cart Functions

Document Cart Page Bar

The Document Cart page bar provides the following functions:

- *Print Cart* – Click this link to print the entire contents of the cart.
- *Download* – Click this link to download the document(s) in the cart to locally-accessible storage. Multiple documents are compressed as a Zip file.
- *Empty Cart* – Empty the entire contents of the cart without having to iterate through each page to delete the documents in the cart. Note: This does not delete the documents from the XE repository. It will only remove the documents from your cart.

- *Import Cart* – Specify an XML file that contains search criteria. XE will use this search criteria to import documents into the cart. A CSV file may also be specified as well as manually entering search criteria that will be used to find documents to place into the cart.

Note

The *Import Cart* function is not available to Trading Partner users.

- *Back to Search Results* – Return to the search results page.

Document Cart Option Bar

The Document Cart option bar allows you to select or deselect documents displayed, print, download or remove documents in the cart and change how the search results are displayed.

- *Select All* – Selects or deselects all documents on the page.
- *Print* – Print the selected documents.
- *Download* – Downloads the selected document(s) to locally-accessible storage. Multiple documents are compressed as Zip file.
- *Delete* – Remove the document from the cart.
- *Display* – Display the documents in the cart with a thumbnail sketch (*Thumbnail*) of the document and its attributes, or with only the documents' attributes (*Condensed*).

Document Cart Content Area

The Document Cart content area lists all documents placed in the cart and a subset of each document's attributes (the number of attributes displayed is configured by the system administrator). For each document you can perform an action such as view the document, view all document properties, print the document or download the document, using the following functions:

- *Select box* – Select documents individually for the purpose of printing, downloading, or removing from the cart.
- *View* – Click the View icon, link or thumbnail image (if displayed) to open a document with DigitalPaper XE's Document Viewer. See *Working with Documents* for more information.
- *Properties* – Displays all attributes associated with a document, and allows you to view, print, or download the document, as well as view its revision history and saved ViewMarks, if any. See *Working with Documents* for more information.
- *Print* – Print the document.
- *Download* – Downloads the document(s) to locally-accessible storage.
- *Reorder* – To rearrange the order of documents in the cart, select the up or down arrow. This may be useful to print the contents of the cart in a specific order.

Sort Documents in the Cart

The Document Cart content area allows you to sort the documents based on a document attribute if sorting has been configured by the administrator. For example, assume that the system has been configured to allow sorting on the "Doc No (P/N)" attribute. The following figures show that the sort attribute is delineated as a hyperlink preceded by a caret (^). Clicking on any of these hyperlinks will sort the documents in ascending or descending order based on the sort attribute. The caret preceding the attribute name indicates the direction of sorting.

Document Attributes						Revision	Action	
<input type="checkbox"/>	^	Doc No (P/N): 25670	Doc Name: NKE Smoke Assembly	Model: NKE Smoke	Model Type: Manufacturing	Related Site: www.nkesmoke.com	D	[Icons]
<input type="checkbox"/>	^	Doc No (P/N): 25671	Doc Name: BT60 Body Tube	Model Type: Manufacturing	Related Site: www.nkesmoke.com	A	[Icons]	
<input type="checkbox"/>	^	Doc No (P/N): 25675	Doc Name: Engine Hook	Model Type: Manufacturing	Related Site: www.nkesmoke.com	A	[Icons]	
<input type="checkbox"/>	^	Doc No (P/N): 25676	Doc Name: Decal (United States)	Model Type: Manufacturing	Related Site: www.nkesmoke.com	A	[Icons]	
<input type="checkbox"/>	^	Doc No (P/N): 25677	Doc Name: Decal (Access Panel)	Model Type: Manufacturing	Related Site: www.nkesmoke.com	A	[Icons]	

Figure 9.2: Document Cart (Condensed View)

<input type="checkbox"/>	View Properties Print Download		Revision: D ^ Doc No (P/N): 25670 Doc Name: NKE Smoke Assembly Model: NKE Smoke Model Type: Manufacturing Related Site: www.nkesmoke.com Sheet: 1
<input type="checkbox"/>	View Properties Print Download		Revision: A ^ Doc No (P/N): 25671 Doc Name: BT60 Body Tube Model Type: Manufacturing Related Site: www.nkesmoke.com
<input type="checkbox"/>	View Properties Print Download		Revision: A ^ Doc No (P/N): 25675 Doc Name: Engine Hook Model Type: Manufacturing Related Site: www.nkesmoke.com
<input type="checkbox"/>	View Properties Print Download		Revision: A ^ Doc No (P/N): 25676 Doc Name: Decal (United States) Model Type: Manufacturing Related Site: www.nkesmoke.com
<input type="checkbox"/>	View Properties Print Download		Revision: A ^ Doc No (P/N): 25677 Doc Name: Decal (Access Panel) Model Type: Manufacturing Related Site: www.nkesmoke.com

Figure 9.3: Document Cart (Thumbnail View)

Note

During the DigitalPaper XE site configuration, the attributes that may be sorted in the document cart display are configured by the system administrator.

Note

During the DigitalPaper XE site configuration, the document cart may be configured to persist only for the user's session or it may be configured to persist across sessions. This means the user may logout and log back in and their cart will still contain the documents that were added to it before the user logged out.

Chapter 10

Options, Help, and Logout Functions

This chapter describes the DigitalPaper XE Options, Help, and Logout main menu functions:

- *Options Menu.*
- *Help Menu.*
- *Logout Menu.*

Options Menu

The Options menu provides the following functions:

- *My Profile* – Edit your user profile.
- *My Preferences* – Edit your user preferences.
- *Print Job Status* – Check the status of your print jobs.
- *Download DPPrint Setup* – Download the DPPrint helper application for printing images locally.

To access the User Options page, click the *Options* link in the navigation bar. The User Options page will appear.

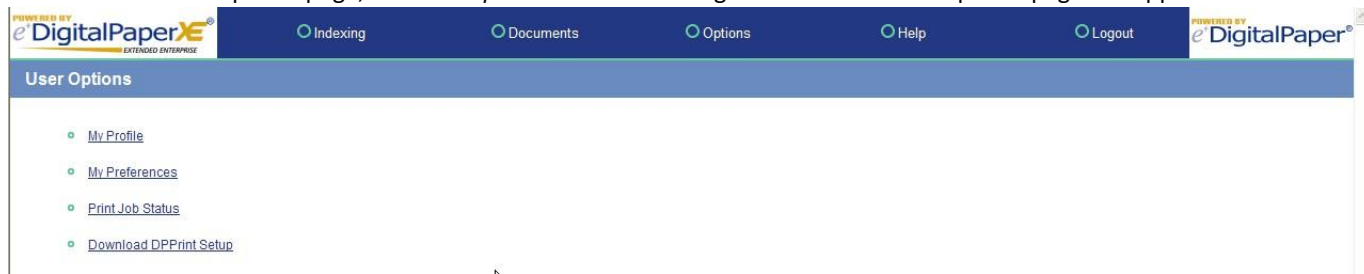

Figure 10.1: User Options Page

Update Your Profile

To modify your profile, perform the following functions:

1. Click the *My Profile* link in the User Options page.
2. The My Profile page appears.

The screenshot shows a 'My Profile' page with a blue header. Below the header, the following fields are visible:

- User Name: arodgers
- * Password: [masked with dots]
- * Re-enter Password: [masked with dots]
- First Name: Aaron
- Last Name: Rodgers
- Company Name: ePlus
- * Email Address: a.rodgers@eplus.com

At the bottom of the form are two buttons: 'Save' and 'Cancel'.

Figure 10.2: My Profile page

- You can change any of the options displayed in this page except your username:
 - To change your password, enter the new password in the *Password* field, then re-type the password in the *Re-enter Password* field. Please contact the DigitalPaper XE system administrator for the password policy that has been implemented.
 - Change your *First Name* or *Last Name* if needed.
 - Change your *Company Name* if needed.
 - Enter a new *Email Address* as needed.
- Click *Save*.

Update Your Preferences

To personalize default display and printer settings to match your preference for each, do the following:

- Click the *My Preferences* link in the User Options page. The My Preferences page appears.

The screenshot shows a 'User Preferences' page with a blue header. Below the header, the following settings are visible:

- Display Mode: Condensed
- Hits Per Page: 10
- Cabinet: All
- Printer: 8830
- Main Viewer Resolution: 896 x 640
- DocPak Viewer Resolution: 896 x 640
- Indexing Viewer Resolution: 896 x 640
- DigitalPaper XE Viewer: DPXE Viewer
- BoM Status for Search: All
- BoM Search Sort Order: Title, Ascending

At the bottom of the form are two buttons: 'Save' and 'Cancel'.

Figure 10.3: User Preferences page

2. You can change any of the options displayed in the page as desired:

- *Display Mode* refers to the default value of the Display results as field, which appears in the Search for Documents page and enables you to specify how you want the results/documents list in the Search Results page displayed (Condensed, Thumbnail, or Sorted).
- *Hits per page* refers to the default value of the Number of results per page field, which appears in the Search for Documents page and enables you to specify how many documents you want listed at one time in the Search Results page.
- *Cabinet* refers to the default value of the Select Cabinet field, which appears in the Search for Documents page and enables you to specify in which cabinet(s) you want to search for documents.
- *Printer* refers to the default value of printer from the list of printers available. This is most helpful if you print mostly to a specific printer.
- *Main Viewer Resolution* refers to the default value of the Viewer Resolution within the DigitalPaper XE viewer. This is most helpful to users with a unique monitor resolution that is different than the global default value.
- *Indexing Viewer Resolution* refers to the default value of the Indexing Viewer Resolution within the DigitalPaper XE viewer. This is most helpful to users with a unique monitor resolution that is different than the global default value.
- *DocPak Viewer Resolution* refers to the default value of the Viewer Resolution while viewing documents within a DocPak. This is most helpful to users with a unique monitor resolution that is different than the global default value.
- *DigitalPaper XE Viewer* refers to the classic and modern Digital Paper viewers. Select *DPXE Viewer* to use the modern DPXE viewer; select *Classic Viewer* to use the classic viewer.
- *BoM Status for Search* refers to the default status-based search criteria to use when searching BoMs. Select *All*, *Pending*, *Active*, *Expired*, or *Archived* as appropriate.
- *BoM Search Sort Order* refers to the default key and order to be used when sorting search results. Select *Title*, *Description*, *Updated*, *Effective*, *Expires*, or *Status* for the key and *Ascending* or *Descending* for the order.

3. Click *Save*.

Check Print Job Status

You may check the status of any print job that has been submitted via the Digital Paper Print Server.

Note

Print jobs submitted to the *Client* profile will NOT have their status provided here. You must check printer job status on your local workstation for these print jobs.

To check print job status, see *Print Job Status*.

Download the DP Print Helper Application

If you are instructed to do so, download the DP Print Helper application from the User Options page, then run the downloaded executable. If you do not, you will not be able to perform client-side printing, copy documents to the clipboard, or print a selected area from the Viewer as described in *Working With Documents*.

For more information, see *About DPPrint*.

Help Menu

The Help Menu provides links to DigitalPaper XE documentation in PDF format.

To access these documents, do the following:

1. Click the *Help* link in the navigation bar. The Help page appears.



Figure 10.4: Help page

2. Click on the link for the document of interest. The file will be downloaded to your workstation and opened in the viewer associated with PDF files.

Note

Only those documents relevant to your DigitalPaper XE role(s) will be displayed on the Help page.

Logout Menu

The Logout menu logs you out from the DigitalPaper XE system.

To log out, click the *Logout* link from the navigation bar. You will be returned to the main DigitalPaper XE login page.

Chapter 11

Print Options

This chapter consists of the sections listed below that describe the print options supported by DigitalPaper XE:

- *Print Options.*
- *Print Job Status.*
- *About DPPrint.*

Print Options

Printers are set up and maintained by the Application Configuration Specialist through the use of printer profiles. DigitalPaper XE supports most printers and plotters. This section describes the different types of options that may be available through these printer profiles.

Printer Options Page

When the *Print* button or link is selected from the *Viewer*, *Document Search Results* page, *Document Properties* page, any page launched from the *Document Properties* page, or from a DocPak, a printer options page appears.

DigitalPaper XE® - Microsoft Internet Explorer

Printer Options

Select Printer: Xerox 285-ST

Number of Copies
Number: 1

Print Job Description
Description:

Scaling Mode
Scaling Mode: Fit To Page

Image Rotation
Degrees To Rotate: No Rotation

Tiling
Multiple Page Printing: Print One Page Only

Color Printing
Color/BW Selection: Use All Available Colors

Print Job Accounting
Account Name:

Viewmark Options

Select Viewmark to Print: Please review my comments!

Select Viewmark Options: Do not print a viewmark

Print Cancel

Figure 11.1: Sample printer profile

Common Print Options

Print options may vary depending on which printer is selected from the Select Printer pulldown menu. The following presents a list of options which may be available.

- *Number of Copies*—Enter the number of copies of the document you wish to print.
- *Print Job Description*—A brief description of the print job. This description is displayed when viewing the status of the print job as described in *Print Job Status*.
- *Scaling Mode*—Controls the size of the printed document. Common options:
 - As Large as Possible
 - Original Size – Fit to Page.
- *Image Rotation*—The number of degrees the user wishes to rotate the image’s orientation on the printout. For example:
 - No Rotation
 - 90 degrees
 - 180 degrees
 - 270 degrees
- *Single Scale Factor*—Used to control the size of the image to be printed (e.g., to print a document that is 2 ½ times the size of the image, enter 2.5)
- *X and Y Scale Factors*—Used to control the size of the image by entering a scale factor for each of the document’s X and Y coordinates.
 - X Scale Factor
 - Y Scale Factor
- *Image Size*—Specify the image’s dimensions, in meters, for the following:
 - Width
 - Height
 - Distance From Left Edge
 - Distance From Bottom Edge
- *Tiling*—Controls multi-page printing options:
 - Print One Page Only
 - Print Images on Multiple Pages
- *Color Printing*—Controls color or black & white options. For example:
 - Pure Black and White
 - Simulated Grey Scale
 - True Grey Scale
 - Simulated Color
 - Use All Available Colors

Note

Color and grayscale server printing is only supported for devices that support color/greyscale printing of TIFF files. An attempt to print an unsupported format will produce an error message.

Color images can produce huge bitmaps. Computers running the DPPrint application may fail or perform slowly if the system has inadequate CPU and memory.

Stamping is not supported for color images. If global stamping is enabled by the Administrator, color printing will not work, and the system will generate an error message.

Printing of color images is restricted to single sheet up to but not including *E* size and less than or equal to 400dpi.

- *Print Job Accounting*—Used to enter the account name for the print job.
- *Collate*—Specify whether or not you want a print job to be collated (On/Off).
- *Activate Folder*—Change the Folder State to On or Off.
- *Fold Program*—Determines the type of folding you wish to perform related to your printer. Select a fold program from a list of available programs.
- *Media Type*—Used to select the type of media to print the document upon. For example:
 - Paper
 - Transparency
 - Film

ViewMark Options

If the document has saved ViewMark(s), the following options are available:

- Select *ViewMark to Print*—Provides a list of saved ViewMarks to choose from.
- Select *ViewMark Options*—Select None, Black and White, or Color.

Local Printing

If printing to a local printer (i.e., client-side printing), you may have to do the following:

- Enter your network username and password. Enter the information and click OK.
- If the DP Print Setup helper application has not yet been installed on your computer, you must install it. See *About DPPrint* for more information.

Print Stamps

Stamping refers to the placement of text "stamps" on printed documents. Print stamps are predefined pieces of text such as date, time, or drawing number, and can be applied in the center of a document or along the borders of a document. The stamping feature works with all printing and download resources. Up to nine stamps can be printed on a single document in various locations. The stamps printed on the document are determined by the DigitalPaper XE Administrator.

Watermarks

Watermarks are faint text objects that appears to be in the background of a document. They are frequently used for identification purposes or for legalities such as copyright information. They may also be a company's name or a user's ID number, or even a document number.

Additionally, watermarking is beneficial for tracking purposes as you can quickly find your documents when they contain familiar watermarks. The watermarks printed on the document are also determined by the DigitalPaper XE Administrator.

Print Job Status

You have the ability to check the status of all your print jobs on an enabled Digital Paper Print Server or cancel a print job through the *Print Job Status* page shown below. The *Print Job Status* page is available by selecting the *Options* link from the navigation bar, then clicking *Check Print Job Status* from the *User Options* page.



Job ID	Description	User Name	Submitted	Status
<input type="checkbox"/> 118	Rocket Assembly print job	jsmith	24.10.2003 08:12:12	PRINTING
<input type="checkbox"/> 110	Print Job Description	jsmith	23.10.2003 10:46:03	SPOOLING
<input type="checkbox"/> 115	Printing RFP	jsmith	23.10.2003 10:30:56	PRINTING
<input type="checkbox"/> 109	Test print	jsmith	23.10.2003 09:46:00	ERROR
<input type="checkbox"/> 102	Checking print quality of scanned image	jsmith	14.10.2003 10:50:56	SUBMITTED

Figure 11.2: Print Job Status page

Print Job Status Page Bar

- *Select a Printer*—Select the print device whose print job status you wish to view.
- *Refresh*—Updates and re-displays all pending print jobs.

Print Job Status Option Bar

- *Select All*—Selects or deselects all print jobs on the Print Job Status page.
- *Cancel*—Terminates all of your print jobs selected.

Print Job Status Content Area

- *Job ID*—The number of each print job submitted to the Digital Paper Print Server.
- *Description*—Text description of the print job entered. *See Printer Options Page.*
- *User Name*—Username of the person who submitted the print job.
- *Submitted*—Date and time the print job was submitted to the print device.
- *Status*—The status can be one of the following:
 - SUBMITTED—The job is ready to go and is waiting to be processed.
 - SPOOLING—The job is being processed by the print server (e.g., print stamps are being applied).
 - PRINTING—The actual data is being streamed to the printer.
 - ERROR—An error occurred while processing the job.

If there is no ERROR, the normal status sequence is: SUBMITTED—SPOOLING—PRINTING.

When the status leaves PRINTING (assuming no ERROR), the print job no longer has a reported status.

About DPPrint

DPPrint enables additional printing options. Once installed, the DPPrint plug-in can be used to:

- Print high resolution images on a local printer (client-side printing).

- Print a selected region of an image displayed in the Viewer.
- Copy all or part of an image displayed in the Viewer to the Windows® clipboard.

Note

The capabilities of the DPPrint plug-in are available for Windows® environments only.

Downloading DP Print

If DPPrint has not been installed, you must use the *Options/Download DPPrint Setup* menu item to download the installer to your computer. You must then run the installer to install DPPrint on your computer.

You will see the following when DPPrint installation has been completed:

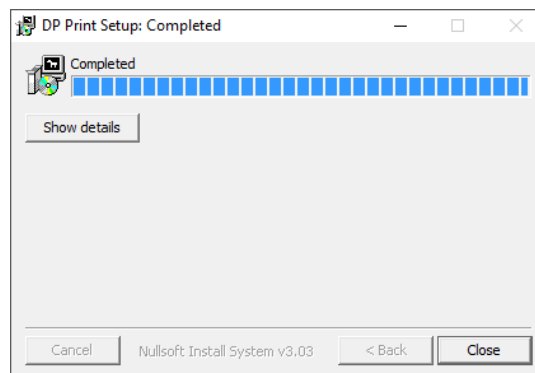
**Using DPPrint**

Whenever you print one or more documents via client printing, print a region of an image, or copy a region of an image to the clipboard, the data to be printed or copied will be downloaded to your computer as a special *DPR* file (file extension *.dpr*). To print or copy the data, simply double-click on the *.dpr* file and the DPPrint application will launch.

When copying a region of data, DPPrint will respond with the following message once the portion of the image has been copied to the clipboard:

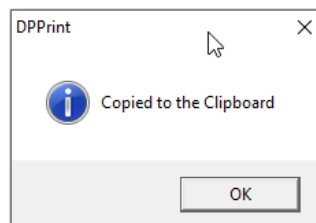

When printing, DPPrint will display the following dialog box:

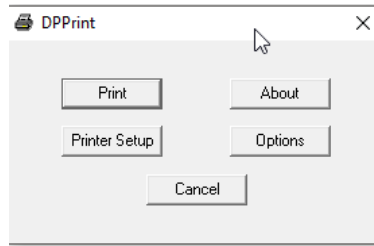

Select options and setup the printer, then press *Print* to print.

Chapter 12

Viewer Tools

This chapter consists of the sections listed below that describe the tools available to view and mark up documents that reside in the DigitalPaper XE system:

- *Document Viewer.*
- *Annotation Tools (ViewMark).*

NOTE: If you are using the modern viewer – *DPXE Viewer* – please see *DPXE Viewer* in *Chapter 4 – Working with Documents*.

Classic Document Viewer

DigitalPaper XE's viewer tool lets you display and navigate through documents that were imported as BMP, GIF, JPEG, or PNG types or formats, as well as file that have been converted to TIFF or DpCI during the import process. You can view documents of any size, print and download displayed documents, as well as annotate and e-mail the marked up copy to other Enterprise Users and Trading Partners (as discussed in *Annotation Tools (ViewMark)*).

To utilize the viewer functions, you must click a thumbnail image, *View* link or icon  from any page that contains a list of documents or a document's properties.

Single Page Document

Opening a single page document displays the viewer window similar to the one shown below.

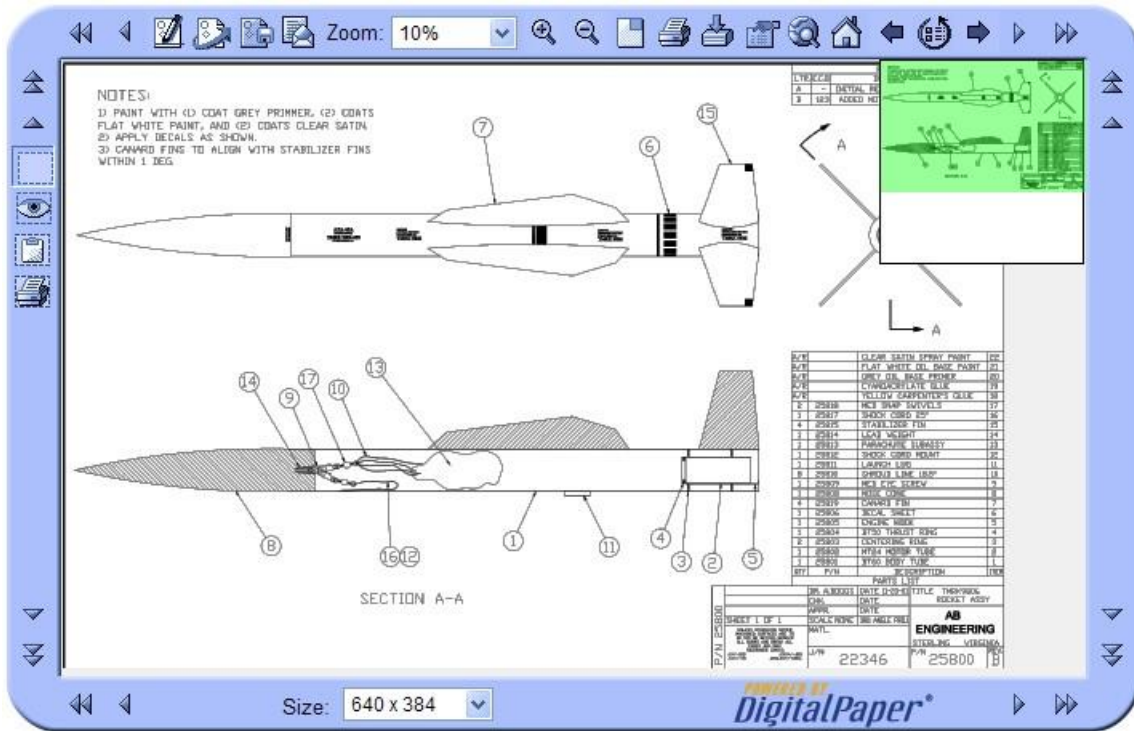

Figure 12.1: DigitalPaper XE Viewer

The viewer window provides you with the options listed in the *Viewer Functions*.

Multi-page Documents

Opening a multi-page document into the viewer will display a page list in the left pane and the first page of the document in the right pane as shown below.

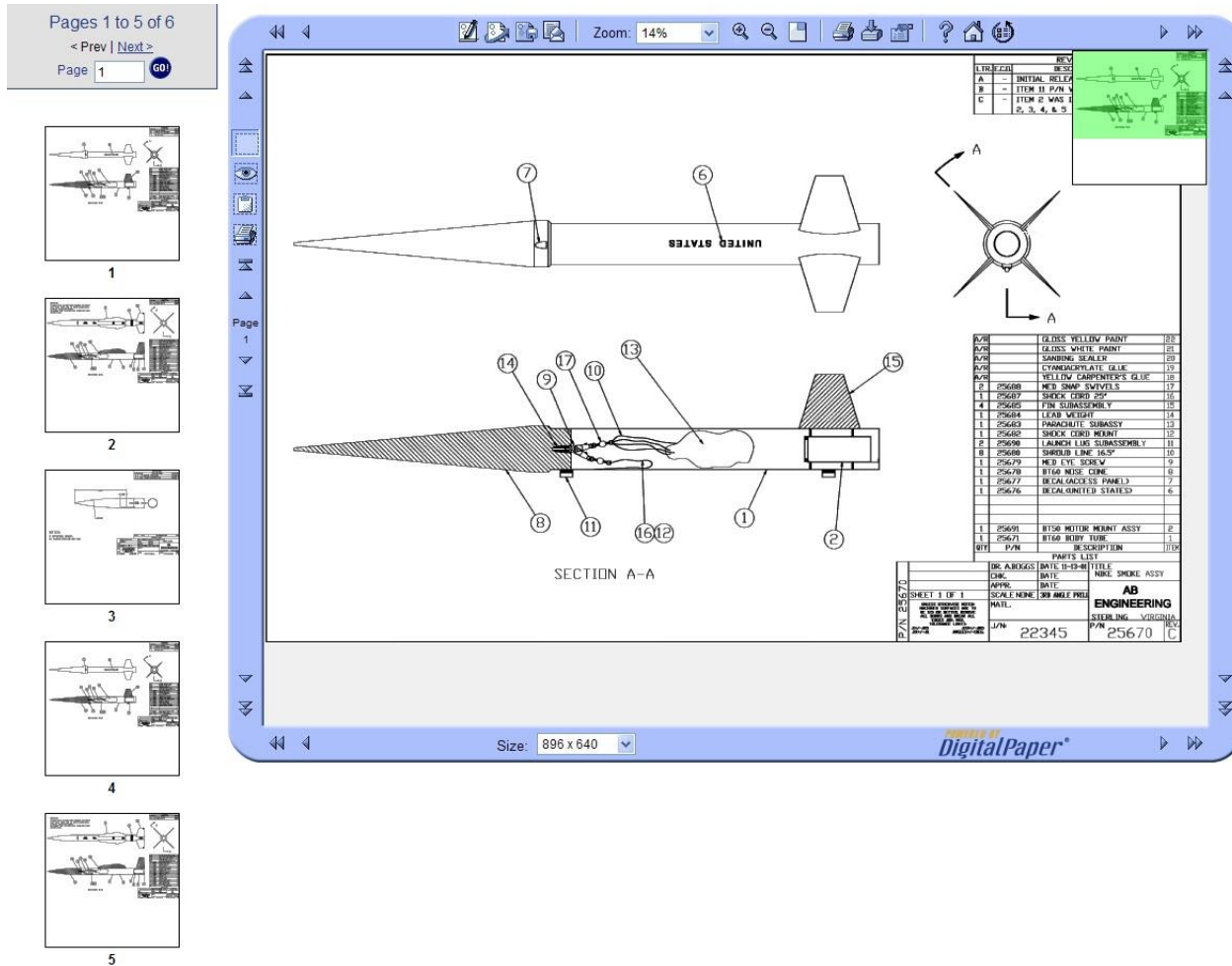



Figure 12.2: Multi-page Document Within the Viewer

Page List (left pane)

The page list acts as a table of contents, displaying the number of the page currently shown in the right pane and the total number of pages contained within the document. In addition, the page list provides navigation to the pages not displayed using the tools below.

- *Page* text field and *Go* button – Enter the page number (displayed beneath each thumbnail) in the text field then click the *Go* button  to display the page in the right pane. The page number of the currently displayed document will appear at the top of the page list and in the mid-left portion of the viewer frame.
- *<Prev | Next>* – Displays the previous set of thumbnails or the next set of thumbnails.

Note

This feature is used to display the next or previous set of thumbnails. Clicking one of these links will not affect the document page displayed in the right pane.

- *Thumbnail* – Click a thumbnail image to display the full page in the right viewer pane.





Viewer Window (right pane)

The viewer window in the right pane provides you with the options listed in the *Viewer Functions*.

Viewer Functions

The viewer window frame includes icons and pulldown menus that let you perform the functions listed below.

Viewer Frame (Top)

- *Pan Arrows* (left) 
 - *Frame Double Arrow* (left) – Moves the document the distance equivalent to one viewer window frame to the left.
 - *Pan Single Arrow* (left) – Moves the document approximately a half-inch to the left.
- *Create ViewMark*  – Opens the ViewMark toolbar. For more information, see *Create ViewMark Toolbar*.
- *Load ViewMark*  – Opens the Saved ViewMark toolbar allowing you to view a saved ViewMark. For more information, see *Load ViewMark Menu*.
- *Save ViewMark*  – Saves the current ViewMark. For more information, see *Save ViewMark*.
- *Send ViewMark*  – E-mails a URL of the current document view with markups to another user. The e-mail recipient displays the document in the viewer by clicking the hyperlink enclosed in the e-mail message. For more information, see *Send a ViewMark via E-mail*.
- *Zoom* – This menu contains options to modify the displayed document's magnification by a percentage of the document's original size or by scaling the document to fit the constraints of the viewer window.

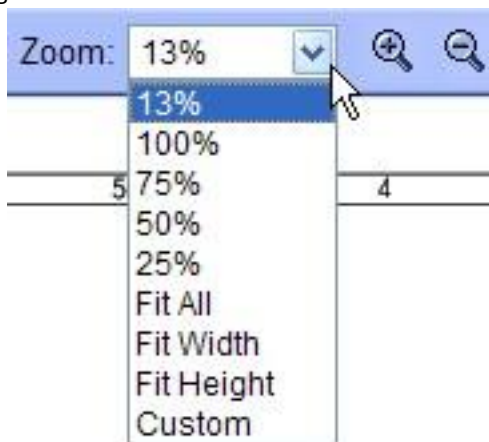





Figure 12.3: Zoom Menu

- *100%, 75%, 50%, 25%* – Changes the magnification based upon a percentage of the document's original size.
 - *Fit All* – Modify the document's magnification so the document fills the entire viewer window (top to bottom and side to side).
 - *Fit Width* – Modify the document's magnification so the document fills the entire width of the viewer window (side to side).
 - *Fit Height* – Modify the document's magnification so the document fills the entire height of the viewer window (top to bottom).
 - *Custom* – When selected a popup box will display. Enter a value between 1 and 400. The value entered will be the percentage used for the magnification of the document's original size.
- *Zoom In*  – Incrementally increases the entire document's or a selected area's magnification.

- **Zoom Out**  – Incrementally decreases the document’s or a selected area’s magnification.
- **Bird’s Eye View**  – Displays a miniature view of the entire document in the top right corner of the viewer. This feature is used to navigate through the image; clicking a point within the Bird’s Eye View will re-center the current view of the document to the selected location while maintaining the current zoom level.

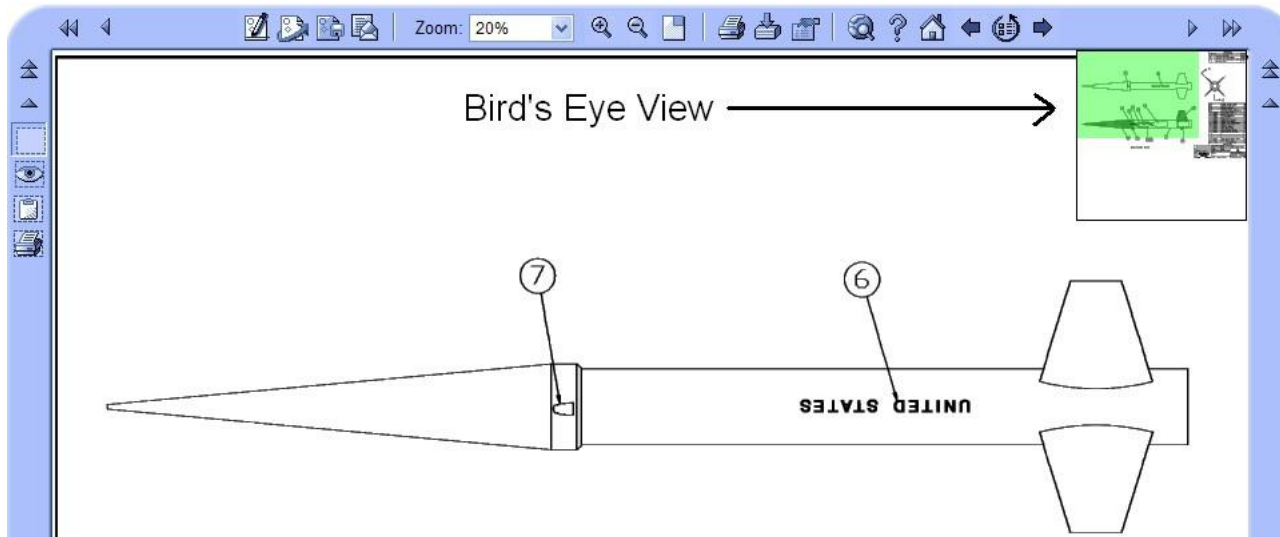













Figure 12.4: Bird’s-Eye View

- **Print**  – Displays the Print Options page used to print a document, and optionally associated ViewMark annotations (if any). For more information, see Printer Options Page.
- **Download**  – Downloads the displayed document (without ViewMarks) to locally-accessible storage.
- **Previous Document**  – Displays the previous document contained in the document list. If the viewer was opened into a separate window, this option is not available.
- **Close Viewer**  – Closes the viewer and returns you to the document list.
- **Next Document**  – Displays the next document contained in the document list. If the viewer was opened into a separate window, this option is not available.
- **Open Viewer in New Window**  – Displays the viewer in a separate window instead of within a frame.
- **Pan Arrows (right)** 
 - *Pan Single Arrow* (right) – Moves the document approximately a half-inch to the right.
 - *Frame Double Arrow* (right) – Moves the document the distance equivalent to one viewer window frame to the right.

Viewer Frame (Left)

- **Pan Arrows (up)** 
 - *Frame Double Arrow* (up) – Moves the document the distance equivalent to one viewer window frame upward.
 - *Pan Single Arrow* (up) – Moves the document approximately a half-inch upward.
- **Define Area**  – Selects an area (the “selected region”) within the viewer.
- **View Area**  – Magnifies the selected region in the viewer.

- **Copy Area to Clipboard**  – Copies the selected region of the document to the computer’s clipboard so it can be pasted into another document.



Note

The Copy Area to Clipboard function requires installation of the DPPrint application on the local workstation.

- **Print Area**  – Prints the selected region of the document to the default printer.

Note



The Print Area function requires installation of the DPPrint application on the local workstation.

- **First Page of a Multi-page Document**  – Displays the first page of the document (if a multi-page document).
- **Previous Page of a Multi-page Document**  – Displays the entire previous page of a document if you are not already on the first page (if a multi-page document).

Note

The current number of the page is displayed in between the previous and next page icons.

Page
2

- **Next Page of a Multi-page Document**  – Displays the entire next page of a document if you are not already on the last page (if a multi-page document).
- **Last Page of a Multi-page Document**  – Displays the last page of the document (if a multi-page document).

- **Pan Arrows (down)** 
 - **Pan Single Arrow (down)** – Moves the document approximately a half-inch downward.
 - **Frame Double Arrow (down)** – Moves the document the distance equivalent to one viewer window frame downward.

Viewer Frame (Bottom)

- **Pan Arrows (left)** 
 - **Frame Double Arrow (left)** – Moves the document the distance equivalent to one viewer window frame to the left.
 - **Pan Single Arrow (left)** – Moves the document approximately a half-inch to the left.
- **Viewer Window Size** – Modify the viewer window size to the respective width and height values listed in the figure below without affecting the zoom value of the document being displayed.

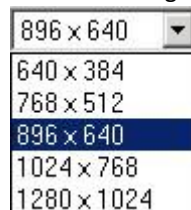





Figure 12.5: Image Size Options

- **Pan Arrows (right)** 

- *Pan Single Arrow* (right) – Moves the document approximately a half-inch to the right.
- *Frame Double Arrow* (right) – Moves the document the distance equivalent to one viewer window frame to the right.

Viewer Frame (Right)

- Pan Arrows (up) 
 - *Frame Double Arrow* (up) – Moves the document the distance equivalent to one viewer window frame upward.
 - *Pan Single Arrow* (up) – Moves the document approximately a half-inch upward.
- Pan Arrows (down) 
 - *Single Arrow* (down) – Moves the document approximately a half-inch downward.
 - *Frame Double Arrow* (down) – Moves the document the distance equivalent to one viewer window frame downward.

Viewer Frame (Corners)

- *Old Revision Alert*  – Indicates the document displayed in the viewer is an old revision and that a more current version is available to be viewed. Simply click the Old Revision Alert exclamation mark to display the current version in the viewer.

Annotation Tools (ViewMark)

With the ViewMark feature, you can overlay rectangles, circles, arrows, text and highlight annotations onto a document, then share these annotations via e-mail with other Enterprise Users and Trading partners for the purpose of collaboration.

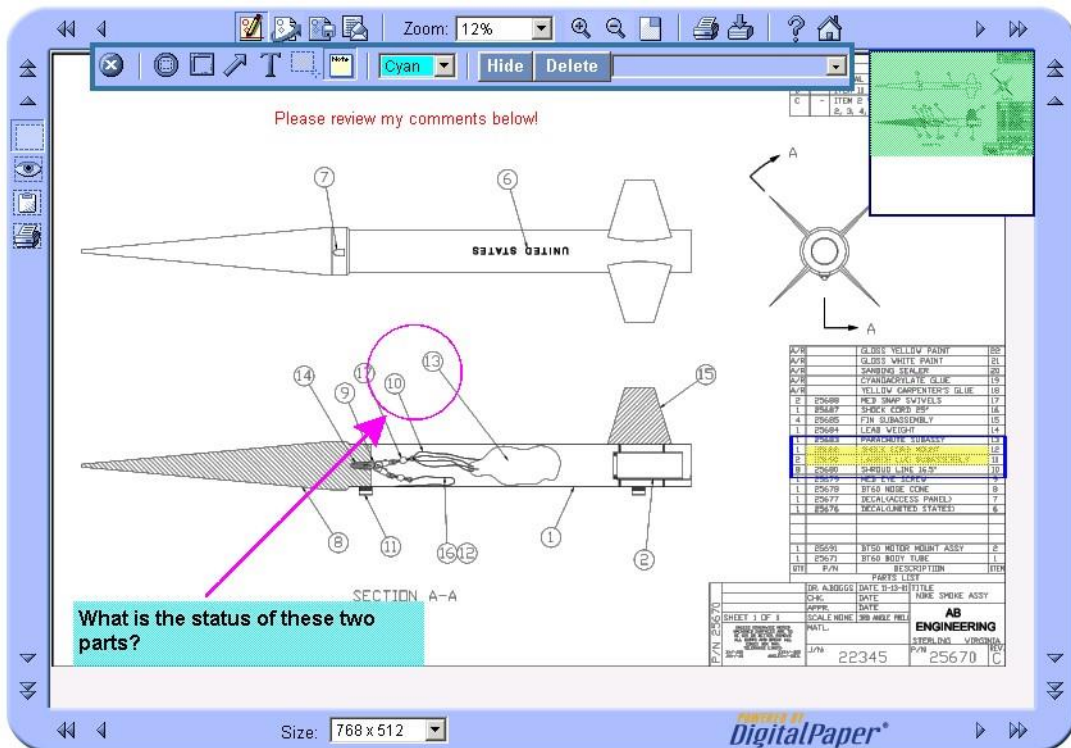



Figure 12.6: Sample ViewMarks

Create ViewMark Toolbar

To enable the ViewMark toolbar, click the *Create ViewMark* button . The ViewMark toolbar then appears directly beneath the Create ViewMark icon as shown below.

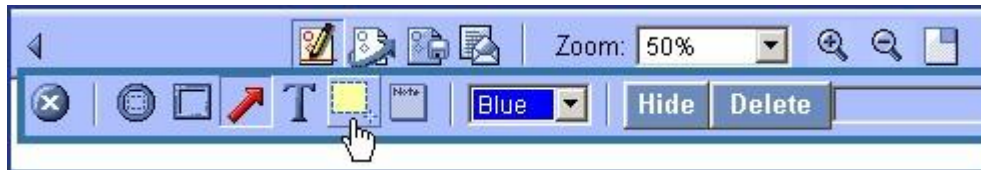



Figure 12.7: ViewMark Toolbar

The following describes the ViewMark toolbar's buttons and functions:

- **Cancel**  – Toggles the tool selected in the toolbar and removes the selection box or green cross-hair selection cursor associated with each tool described below.
- **Circle**  – Enables a circle to be overlaid on the document's image. The size of the circle depends on the size of the selection box drawn; the circle is drawn immediately outside of the four corners of the selection box.

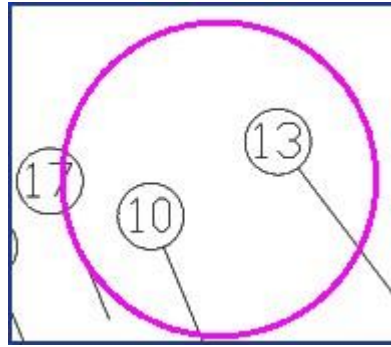



Figure 12.8: Circle

- **Rectangle**  – Enables a rectangle to be overlaid on the image. The start point (green cross-hair selection cursor) represents the first corner of the rectangle. Drag the cursor to the opposite corner to define the rectangle size.

A/R		YELLOW CARPENTER'S GLUE	18
2	25688	MED SNAP SWIVELS	17
1	25687	SHOCK CORD 25"	16
4	25685	FIN SUBASSEMBLY	15
1	25684	LEAD WEIGHT	14
1	25683	PARACHUTE SUBASSY	13
1	25682	SHOCK CORD MOUNT	12
2	25690	LAUNCH LUG SUBASSEMBLY	11
8	25680	SHROUD LINE 16.5"	10
1	25679	MED EYE SCREW	9
1	25678	BT60 NOSE CONE	8

Figure 12.9: Rectangle

- **Arrow**  – Defines an arrow where the start point (green cross-hair selection cursor) represents the tail of the arrow. Drag the cursor to the end point of the arrow head.

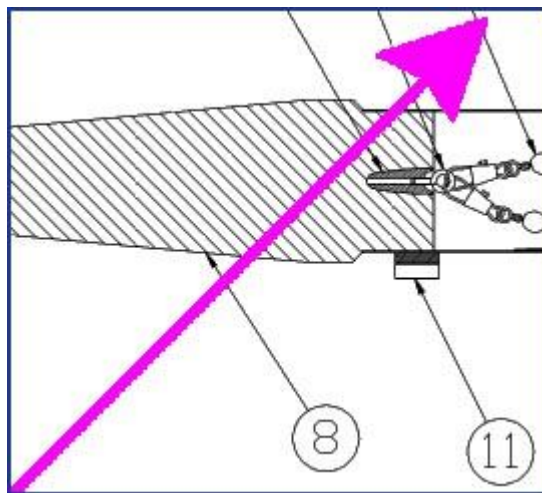

Figure 12.10: 45° Arrow



- **Text**  – Displays a text dialog when the cursor is placed within the document image and the left mouse key is clicked. Enter the text in the dialog to be overlaid on the image within the boundaries of the selection box.



Figure 12.11: Text Dialog

- **Highlighted Area**  – Defines a highlight box to be overlaid on the image. The start point (green cross-hair selection cursor) represents the first corner of the box. Drag the cursor to the opposite corner to create the highlight.

2	25688	MED SNAP SWIVELS	17
1	25687	SHOCK CORD 25"	16
4	25685	FIN SUBASSEMBLY	15
1	25684	LEAD WEIGHT	14
1	25683	PARACHUTE SUBASSY	13
1	25682	SHOCK CORD MOUNT	12
2	25690	LAUNCH LUG SUBASSEMBLY	11
8	25680	SHROUD LINE 16.5"	10
1	25679	MED EYE SCREW	9
1	25678	BT60 NOSE CONE	8
1	25677	DECAL(Access Panel)	7
1	25676	DECAL(UNITED STATES)	6

Figure 12.12: Highlighted Area

- **Highlighted Note**  – Combines the features of the text and highlighted area annotations where text is overlaid upon a highlighted area. When this annotation is selected a text dialog displays when the cursor is placed within the document image and the left mouse key is clicked. Enter the text in the dialog to be overlaid on the image within the boundaries of the selection box. The highlight appears automatically, centered behind the text. The color of the highlight may be selected, but the color of the text is black by default and cannot be changed.

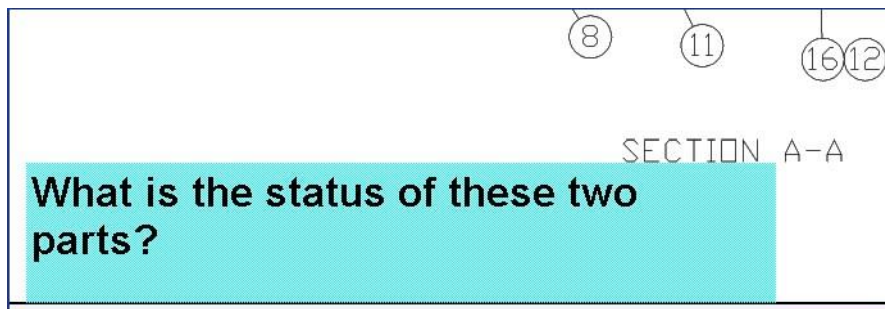

Figure 12.13: Highlighted Note

- *Color Pulldown* menu – Used to select a color for the ViewMark annotation about to be drawn. In the case of a highlighted note, the color is applied to the highlighted background, not the text.

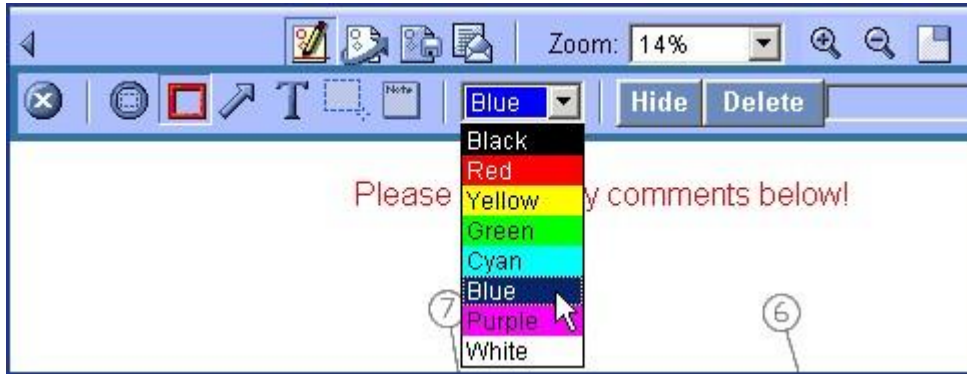

Figure 12.14: Annotation Colour Menu

- *Hide/Show* **Hide** **Show** – Hides or shows the ViewMark annotation currently selected in the ViewMark annotation name drop down list.



Figure 12.15: ViewMark Annotation List

Click *Hide* to hide the viewmark. Click *Show* to show a hidden viewmark.

Note

The *Hide* button only appears for ViewMarks that are not hidden. The *Show* button only appears for ViewMarks that are hidden.

- *Delete* **Delete** – Deletes the annotation currently selected in the ViewMark annotation list. This feature is used to delete a single ViewMark annotation or all ViewMark annotations by selecting All from the annotations drop down list.

Load ViewMark Menu

While in the viewer, click the *Load ViewMarks* icon  to see if any ViewMarks have been saved to this document. Saved ViewMarks are listed in the Load ViewMark menu displayed below.

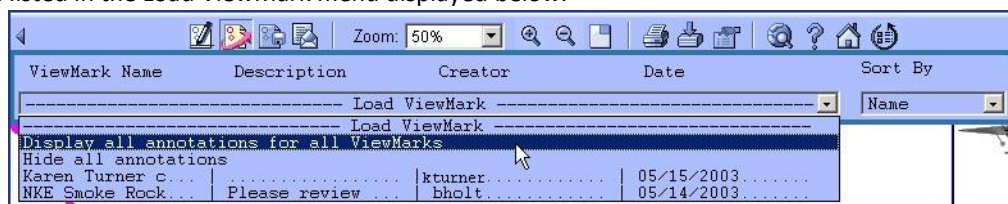

Figure 12.16: Load ViewMark Menu

The ViewMark menu displays the following information about each ViewMark that was entered when the ViewMark was saved (for more information, see *Save ViewMark*):

- ViewMark Name – Unique name of the ViewMark.
- Description – Text description (up to 40 characters) of the ViewMark.
- Creator – Name of the ViewMark author (up to 20 characters).
- Date – Month, day and year the ViewMark was saved.

You can sort on any of these fields by selecting the field of interest from the *Sort By* menu that is located to the right of the Date field in the Load ViewMark toolbar.

Selecting an item from the menu displays the selected ViewMark in the document. If security is set by the Administrator, you may have to enter your username and password to display the ViewMark.

Save ViewMark

To save a ViewMark, click the *Save ViewMark* icon  to display the Save ViewMark option dialog, then enter the following information:

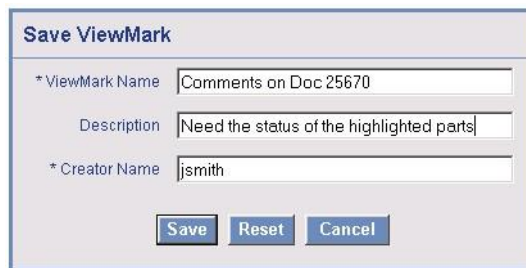

The dialog box titled "Save ViewMark" contains three text input fields and three buttons. The first field, labeled "* ViewMark Name", contains the text "Comments on Doc 25670". The second field, labeled "Description", contains the text "Need the status of the highlighted parts". The third field, labeled "* Creator Name", contains the text "jsmith". At the bottom of the dialog are three buttons: "Save", "Reset", and "Cancel".

Figure 12.17: Save ViewMark Dialog

- ViewMark Name – Unique name of the ViewMark (up to 20 characters) as it will appear in the Load ViewMark menu and ViewMarks page.
- Description – Text description (up to 40 characters) of the ViewMark.
- Creator Name – Name of the ViewMark author (up to 20 characters). If system security is on, you cannot modify the creator name (the creator name will automatically default to your username).

If a ViewMark has been previously saved with the document, the following list of options are available:

- Create Related ViewMark – Creates a new saved ViewMark but relates it to the original saved ViewMark. A related ViewMark will appear linked to the original or the ViewMark.
- Create Top-Level ViewMark – Creates a new ViewMark combining the original ViewMark with the new changes. Similar to "Save As" functionality where the new Viewmark does not need the context afforded by creating a related ViewMark. You will have to provide a new ViewMark name and description.



The dialog box titled "Save ViewMark" contains three text input fields and two radio button options. The first field, labeled "* ViewMark Name", contains the text "Square". The second field, labeled "Description", is empty. The third field, labeled "* Creator Name", contains the text "bbernardino". Below the fields are two radio button options: "Create Related ViewMark" (which is selected) and "Create Top-Level ViewMark". At the bottom of the dialog are three buttons: "Save", "Reset", and "Cancel".

Figure 12.18: Save previously created ViewMark

Note

If this is the first ViewMark to be saved with the document, or a previously-saved ViewMark is hidden, these options are not available.

When complete, press *Save* to save the ViewMark or *Cancel* to abort entry. Press *Reset* to reset all fields to their original values.

Send a ViewMark via E-mail

A user with the proper security permissions can send a view of the document with the markups and annotations to other users via e-mail. ViewMarks are sent by clicking the *Send ViewMarks* icon  from the viewer. When selected, an e-mail window appears with an embedded ViewMark URL.

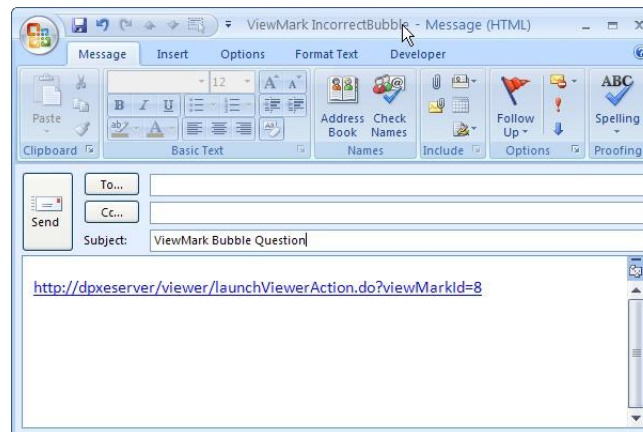

Figure 12.19: E-mail a ViewMark URL

When a user sends e-mail from DigitalPaper XE, the actual documents are not attached to the message so file size is not an issue. The recipient accesses and views the documents using DigitalPaper XE. The recipient must be able to connect to the XE server and have a username and password granting him/her access. Furthermore, the recipient must have access to the cabinets and/or DocPak containing the document(s) being sent.



Part IV Appendices

Appendix A

Supported Document Import File Types

DigitalPaper XE supports the document import file types listed in this section.

Standard Import File Types (Converted to TIFF)

Standard import files are those copied and converted to TIFF (or DPCI, described below) so they can be displayed to Indexing Specialists in the workspace, or upon release, displayed to Enterprise Users and Trading Partner in the DigitalPaper XE Viewer. If the Viewer cannot convert the image to TIFF, the file is imported into the repository in its original format where it is available for download (for more information, see *Native File Types*). Standard import file types supported by DigitalPaper XE include:

- **CALS (Type 1)**—Computer Aided Acquisition and Logistics Support raster format standard developed by the United States Department of Defense to standardize graphics data interchange for electronic publishing, including CAD and image processing applications. Type I raster data files contain a single, monochromatic image compressed using the CCITT Group 4 (T.6 encoding algorithm and appended to a CALS raster header record data block).
- **DPCI**—Digital Paper Composite Image. This file type consists of several PNGs merged together with the metadata at the end of the file on each image's position.
- **PDF**—Portable Document Format. A file format that has captured all the elements of a printed document as an electronic image that a user can view, navigate, print, or forward to another user. DigitalPaper XE supports import of single and multi-page PDFs. If the PDF file is black and white, it will be converted to TIFF where it can be displayed in the Viewer. If it is in color, it will be converted to DPCI, described above, which can also be displayed in the Viewer. DigitalPaper XE also stores the native version of PDF files so it can be downloaded.
- **PostScript**—A language standard, defined by Adobe Systems, to control text and graphics printer formatting and output. A PostScript compatible printer runs a PostScript interpretation program. A computer application can format data (such as a word processing document), and generate PostScript commands, to print text and graphics. DigitalPaper XE supports import of single and multi-page PostScript files. If the PostScript file is black and white, it will be converted to TIFF where it can be displayed in the Viewer. If it is in color, it will be converted to DPCI, described above, which can also be displayed in the Viewer.
- **TIFF**—Tagged Image File Format. A file format used for still-image bitmaps, stored in tagged fields. Application programs can use the tags to accept or ignore fields, depending on their capabilities. DigitalPaper XE supports import of single and multi-page TIFFs.

Color Document Import Limitations DigitalPaper XE's color viewing support is primarily for color line-art. DigitalPaper XE's Viewer will work with full color (photographic type) images but color rendition cannot be guaranteed for this type of usage. Grayscale support also cannot guarantee image fidelity. The following color/grayscale image formats are supported: PDF Version 1.7 or lower, PostScript Level 3 or lower, TIFF Version 6 Color 24-bit uncompressed, TIFF Version 6 Grayscale 8-bit uncompressed, HPGL or HPGL2, JPEG for 24-bit color and grayscale.

Note You cannot rotate color or grayscale images during the import process.

CSV Files

DigitalPaper XE imports comma separated value (CSV) formatted files as document attributes for corresponding image files. For more information on this type of import, see *CSV Attribute Import Example* in the *Administration and Application Configuration Guide*.

CSV files may also be used to perform a search of attributes assigned to released documents in the repository and update attribute values across all documents found in a specific cabinet or across the entire repository. Search and update of attributes is based upon attribute values contained in the CSV file. For more information on this type of import, see *Create the CSV File Containing Search and Update Attribute Values* in the *Administration and Application Configuration Guide* and *Search and Update Pages* in this chapter.

CAD/PDM Files

The DigitalPaper XE Computer Aided Design or Product Data Management (CAD/PDM) interface module is a component of DigitalPaper XE that extends the capabilities of the base system by accepting a wide range of plot file formats created by industry standard CAD systems. With the interface module, customers are able to streamline distribution of documents produced in CAD and PDM systems to users in the field where they can easily search, view, print, and distribute critical documents using their web browser and DigitalPaper XE.

Creating Print Files from CAD/PDM Systems

Typically, CAD and PDM systems create proprietary file formats that may not be portable beyond their native application. While a CAD document is in the creation stage or is being edited, the original file format is valuable to the CAD designers. When the drawing is approved for distribution to end users, it becomes less valuable while it remains in the original file format because users will need the application to view and print it.

While most CAD and PDM systems create proprietary file formats, they can also create print files that are supported by a wider range of applications. Most applications provides the capability to create a PDF file, among others. The PDF file can be saved to a directory on the local hard drive or to a network directory. In the case of using the DigitalPaper XE PDF interface module, PDF files can be saved to predetermined directories that DigitalPaper XE polls automatically. When the DigitalPaper XE import facility encounters a file in the directory, the PDF file is either imported directly or converted and imported into DigitalPaper XE. The drawing is then indexed and released for general distribution.

Supported File Formats The CAD/PM Interface module expands the formats supported by DigitalPaper XE including:

- HP-GL or HP-GL/2—Hewlett Packard Graphic Language/file format.
- CGM/CGM+—Computer Graphics Metafile. A robust vector graphics data format that describes pictures and graphical elements in high-level geometric terms such as lines, circles, arcs, ellipses, polygons, text strings, and cell arrays (image data).
- Other file types may be supported; please contact customer support for more information.

Native File Types

DigitalPaper XE allows storage of all native files since it does not make sense to convert all file types to TIFF. For example, a spreadsheet file can be added to the DigitalPaper XE repository, but since it cannot be converted to TIFF without losing the functionality of the spreadsheet, it is stored in the file's native format with the file's extension name. When a user clicks on the thumbnail or link to this document, the file is downloaded to the user's computer. Assuming the user has made the appropriate application association, the downloaded file will automatically display within the spreadsheet application.

In addition, some business rules may require that the native file be available along with its TIFF counterpart. For files to be stored as a native file, the Administrator can set up the system to keep the native version of the file (in addition to its TIFF counterpart) using the *MIME Map Page* as described in the *Administration and Application Configuration Guide*. If DigitalPaper XE cannot convert the image to TIFF, the file is imported into the repository in its original format where it is available for download.

Native File Types Supported by the Viewer The following file types can be imported into DigitalPaper XE in its native format (without converting them), displayed in the Viewer, as well as downloaded in its native format:

- **BMP**—Bitmap. The native image format for the Windows series and OS/2 operating systems.
- **JPEG**—Joint Photographic Experts Group. A popular image format for use on the Internet. It is optimized for photographs and other continuous tone images.
- **PNG**—A bitmap file format used to transmit and store bitmapped images. PNG files can store up to 16 bits (grayscale) and 48 bits (true color) per pixel, and are used as an alternative to GIF files.
- **TIFF**—Tagged Image File Format. A file format used for still-image bitmaps, stored in tagged fields. Application programs can use the tags to accept or ignore fields, depending on their capabilities. DigitalPaper XE supports import of single and multi-page TIFFs.
- **PDF** – Portable Document Format files.

DocPak Import File Type

DigitalPaper XE import profiles can be configured to automatically poll specific directories for XML files that define an entire DocPak (except Line Items).

- **XML**—Extensible Markup Language. A flexible language designed so that common information formats and data may be shared on the World Wide Web and intranets.

For more information on this type of import, see *Create a DocPak Import Profile* and *DocPak Import Profile Fields*.

Appendix B

ePlus Support

This appendix describes the various technical support options available from ePlus, including:

- *Support Programs.* This section's topics include:
 - *Standard Product Support Program*
 - *Platinum Product Support Program*
 - *Customized Product Support Program*
- *Support Resources.* This section's topics include:
 - *Training.*
 - *Knowledgebase.*
 - *Web Interface Support.*
 - *E-mail Support.*
 - *Telephone.*
 - *Fax Support.*

Support Programs

Standard Product Support Program

DigitalPaper XE's Standard Product Support Program gives you easy access to expert analysts who can quickly resolve any issue with the product. Standard Product Support includes phone, e-mail, and web-based support for two designated company representatives during ePlus's standard business hours (9am–6pm EST, Monday – Friday, excluding ePlus holidays).

Standard Product Support also includes free version updates, which ePlus makes generally available for the products licensed by the company. This ensures that a company always has the latest features and functionality of the product. This does not include installation or professional services costs associated with performing updates or enhancements of customized code, if so required. In addition, Standard Product Support includes access to ePlus's Support web site for:

- Answers to Frequently Asked Questions (FAQs)
- Knowledgebase searches
- Product patches
- On-line product documentation
- Enhancement request submission
- Interface to Support database (allows a user to log and check the current status of incidents).

Platinum Product Support Program

Platinum Product Support is offered to organizations that run production environments in which system uptime is mission critical to their business. In addition to Standard Product Support Program services, Platinum Product Support provides:

- 24 x 7 access to support staff on a call-back basis, including all holidays (after normal business hours, support is limited to "Severity Level 1" issues only).
- A primary Customer Support Engineer (CSE) assigned to the account.
- Authorization for up to four designated representatives to contact ePlus for support.
- Privileged-level access to on-line resources for more advanced support.

Customized Product Support Program

DigitalPaper XE is based on an open architecture, which allows for customization and seamless integration with other key business systems. Customized Product Support is designed to address the unique requirements of organizations to customize ePlus solutions to their environments.

Purchased as an addition to either the Standard or Platinum Product Support Programs, the Customized Product Support Program is based on a pre-arranged annual retainer, which is determined either by the level and type of customization. The retainer is prepaid annually, with any support work performed during the plan year billed against the retainer at standard services rates. If a client expends the full amount of the retainer before the end of the plan year, ePlus may request a pro-rated retainer for the remainder of the plan year. This program does not entitle clients to free updates or modifications to customized code. Such services are available through ePlus's Professional Services Team.

Support Resources

Only ePlus customers that maintain an active Product Subscription or Direct Support Agreement explicitly with ePlus have access to the wide variety of ePlus Customer Support resources. Customers that have purchased products or services directly from a ePlus partner have access only to product documentation and should contact the appropriate ePlus partner for information on the support resources to which they are entitled.

To take advantage of ePlus's Customer Support resources, the organization must also designate certain employees to be Authorized Support Contacts (ASCs) responsible for interfacing with our Customer Support Team. ASCs are generally technical staff whom have completed the Basic System Administration course provided by ePlus's Training Organization. The number of ASCs an organization may designate depends on the service program the organization has elected.

Training

In addition to the Basic System Administration training mentioned above, ePlus Customer Support recommends that ASCs attend Advanced Administration Training. For more information, contact ePlus's Training Group via e-mail at dpsupport@eplus.com or visit the training section of our web site at: <http://customersupport.eplusonline.com/tmtrack/tmtrack.dll>

Knowledgebase

ePlus's Customer Support Team has developed a comprehensive on-line product knowledgebase of current information on all ePlus's products to supplement product documentation. The knowledgebase is categorized for easy searching, enabling a user to get quick answers to questions 24 hours a day. Users will find FAQs, Configuration Information, Tips and Tricks, and much more. Customers that subscribe to our Platinum Product Support Program have an additional "Privileged Access" to more technical information including advanced configuration, troubleshooting tips, error codes, and functional "work-arounds". Search the knowledgebase by clicking on the "Find Answers" link of our Support web site at:

<http://customersupport.eplusonline.com/tmtrack/tmtrack.dll>

Web Interface Support

ASCs from a company can directly log support incidents into ePlus's Customer Support Database through our web-based customer interface. This is the ideal method for contacting our Customer Support Team, as it allows one to completely document a question, attach any relevant example files, and follow-up on the status of incidents 24 hours a day.

To Log an Incident through the Web Interface:

1. Go to <http://customersupport.eplusonline.com/tmtrack/tmtrack.dll>
2. Click Ask a Question then complete the steps. We recommend bookmarking this page for follow up and future use.

E-mail Support

ASCs can e-mail questions or issues directly to the ePlus Customer Support Team at dpsupport@eplus.com

Please include as much detail as possible, including company name, location, complete contact information, version number, and a description of the problem. Also attach any relevant files to facilitate the support process.

E-mails will automatically be entered into our Customer Support Database and logged as support incidents. The sender's e-mail address will be validated against our list of ASCs. If the e-mail address is not from a designated ASC, the sender will receive service denial notification via e-mail. Once validated, the inquiry will be routed to a ePlus Customer Support Engineer (CSE) for resolution/troubleshooting.

Telephone

Recognizing that not all problems are easily communicated on-line, ePlus maintains a toll-free telephone support line staffed by CSEs. Only designated ASCs may call Customer Support.

Toll Free Support Line: (888) 215-6677

Hours of Operation Standard Support—Normal business hours are 9am–6pm EST, Monday–Friday (excluding ePlus holidays)

Platinum Support—24 x 7, 365 days a year on a call-back basis

Note

Platinum customers will be provided with our after-hours support number upon enrollment in the program.

Please have the following information ready before placing a call to Customer Support:

- ePlus product and version installed
- Server Operating System, including version number and patch level
- Remote/Dial-in Access Information
- Complete description of the question or problem
- Steps or actions that led to the question or problem
- Changes that may have been made to the system (hardware or software)
- Any messages or other diagnostic information produced
- Steps required to duplicate the issue in our test lab.

When speaking with a Customer Support Engineer, also mention the following items if they apply to the situation:

- Business deadlines or operational pressures
- Availability (when someone will be able to work with Customer Support)
- Alternative contact numbers (for other ASCs if necessary)
- Other open problems with Customer Support that may be related to the current issue.

Fax Support

Fax questions or requests to Customer Support at (703) 984-8829.

Please include as much detail as possible (company, location, version number, description of the problem, complete contact information) and include any relevant examples.

Appendix C

Glossary

Administrator

The DigitalPaper XE Administrator is responsible for configuring the system's security as it pertains to users that can access the application, the groups to which they belong, and the privileges associated with each group. An Administrator is also responsible for setting up printers, applying system-wide settings and other utility functions.

Application Configuration Specialist

The Application Configuration Specialist defines and applies the attribute schemas that describe each document imported into the system, creates and implements the import profiles that control how documents are imported into the system, sets up the workspaces used by Indexing Specialists to index and release documents to the repository, creates the virtual file cabinets where documents are referenced, and defines the templates available to Enterprise Users to create DocPaks and their associated Line Items. The Application Configuration Specialist may also configure the system to automatically create and publish DocPaks on a scheduled basis.

Attribute

A property of a document that is used to describe the document as well as make it searchable once released to the DigitalPaper XE repository. An attribute that is defined as a Revision Key is used in combination with the document's revision value to determine if the document is unique or whether it is a new revision.

Bird's Eye View

A DigitalPaper XE Viewer function that displays a miniature view of the document just inside or outside of the Viewer frame; the location of the Bird's Eye View is controlled by the Application Configuration Specialist. The user can click an area of the Bird's Eye View to navigate to that particular section in the document.

Cabinet

Analogous to a physical filing cabinet, cabinets are a logical grouping of documents. Cabinets are created by the Application Configuration Specialist who also defines which user groups have permission to search, access and view documents within them.

DirectSight

Digital Paper's patented technology uses streaming algorithms to minimize bandwidth utilization. This allows remote users to efficiently access and collaborate on large technical documents.

DocPak

A feature that allows an Enterprise User to construct a business package consisting of multiple documents (e.g., RFQs, RFPs, work orders) either manually or via import. DocPaks may be published to specific Enterprise Users or Trading Partners via a hypertext link within an e-mail or they may be made "public" so that any of these two types of user can access them. Users with proper privileges to DigitalPaper XE and the DocPak may access, view, annotate, print or download the documents within each DocPak. In addition, specified recipients will be notified via e-mail if a document within the DocPak has changed (e.g., the document has been deleted or a new revision exists).

Document

An object in the DigitalPaper XE repository that contains one or more pages. Documents are temporarily imported into DigitalPaper XE from external sources such as hard drives, CD ROM, etc. Documents may be imported in their native file format, converted to TIFF for display in the DigitalPaper XE Viewer, or both. Once documents have been released to cabinets, they may be searched, accessed, viewed, annotated, printed, or downloaded by users with access to the cabinet where the documents are stored.

DPPrint.exe

A helper application developed and licensed by Digital Paper that facilitates document printing from the users workstation to a Windows® based local printer.

Enterprise User

Users that are allowed to search for documents that have been released to DigitalPaper XE cabinets. If the Enterprise User has access to a cabinet, each document within that cabinet can be viewed, annotated, printed, downloaded, and sent to other Enterprise Users or Trading Partners. Enterprise Users can also assemble multiple documents and publish the collection as a DocPak.

Image

A snapshot of a released document displayed in the DigitalPaper XE Viewer.

Index Specialist

The Indexing Specialist assigns searchable attributes to each document in their workspace, modifies documents with a raster editor on an "as needed" basis, then "releases" documents into DigitalPaper XE cabinets. The Indexing Specialist can edit the attributes or image of a document that has already been released to a cabinet, or delete the document from a cabinet.

Line Item

An element of a DocPak that groups related documents for the purpose of organization.

Repository

A storage and retrieval facility for electronic documents, their associated attributes, and ViewMarks.

Revision Key

One or more attributes that are used to define multiple revisions of a single document stored in the repository.

Revision Level

The attribute that defines the revision of a document in the repository. With the proper permissions (granted by the Application Configuration Specialist for documents stored in a specific cabinet), a user who has access to a document may view an older revision of that document.

Stamping

Text blocks or watermarks overlaid on all document images printed from a Digital Paper Print Server. Print stamps are typically used to ensure revision control, indicate copyright, certify ISO compliance, record the date, etc. The DigitalPaper XE Administrator controls the location and content of print stamps and watermarks.

Trading Partner

Users (typically enterprise customers, suppliers, and business partners) that can access and view DigitalPaper XE documents. Trading Partners can also receive and access DocPaks by simply clicking a hypertext link within an email notification message and/or view publicly available DocPaks. Trading Partners can also annotate, download, and print documents they have access to without affecting the original document and send these comments to the person who sent the document or DocPak.

ViewMark

A feature of DigitalPaper XE that allows a user to *annotate* a document with text, highlights, arrows, circles, or rectangles to illustrate an area that needs to be changed and then communicate that change to another user.

XE Server

The DigitalPaper XE Server is a document repository system tailored for storage and retrieval of released documents over an Intranet or Internet.